

Plumb Supply

COMPANY

2017

HVAC Products

Vol. 2

General Conditions

This price service has been designed to assist you in estimating your jobs. It is our sincere desire to maintain the necessary inventory to satisfy your requirements, but we do not stock all of the items in this catalog.

All orders are subject to approval by our credit department, and the possession of this price service is not to be construed as an offer to sell.

All prices are subject to change without notice and due to market conditions over which we have no control, cannot be guaranteed. Orders will be accepted on the basis of the market price prevailing at the time of shipment.

We cannot be held responsible for any errors or omissions in the price service.

Taxes

Sales tax will be added to all invoices unless you have furnished us with a Sales Tax Exemption Certificate for your purchases.

Return Goods

Materials may be returned for credit with prior approval and authorization from our office. Any material claimed defective that is covered by factory warranty must be accompanied by the necessary warranty information. When authorization to return goods is requested, the date of the purchase and our invoice number must be given to either our salesperson or the office.

Special Materials or Non-Stock Orders

Orders for non-stock or special items cannot be cancelled or returned for credit without factory approval. If approval is obtained, credit will be allowed for the net salvage value allowed by the factory.

Warranty

The products we sell are guaranteed only to the extent of the manufacturer's warranty. No allowances will be made for labor, damage or kindred claims, and Plumb Supply Company cannot be held liable for any product liability claims, freight shortages or other claims over which we have no control.

Contact Information

Corporate Office

515-262-9511
1622 NE 51st Ave
Des Moines, IA 50313

Ames | 515-233-5737

Manager: Wade Brinkmeyer
2408 East Lincolnway, 50010

Des Moines | 515-262-9511

Manager: Pat Nicholson
1622 NE 51st Avenue, 50313

Cedar Rapids | 319-366-7891

Manager: Greg Wolfe
4700 J Street SW, 52404

N. Cedar Rapids | 319-393-1441

Manager: Dave Hof
1716 Blairs Ferry Road NE, 52402

Davenport | 319-393-1441

Manager: Sheldon Converse
4601 Grand Avenue, 52807

Dubuque | 563-556-2827

Manager: Todd Smith
600 Cedar Cross Road, 52003

Fort Dodge | 515-573-8161

Manager: Todd Johnson
1565 Cardinal Avenue, 50501

Iowa City | 319-351-1004

Manager: Brock Barber
225 E. Prentiss Street, 52240

Le Mars | 712-546-8129

Manager: George Regennitter
436 2nd Avenue NE, 51031

Marshalltown | 641-753-2847

Manager: Jake Boesch
207 Iowa Avenue East, 50158

Mason City | 641-423-0164

Manager: Jeff Frahm
45 19th St SW, 50401

Muscatine | 563-264-8655

Manager: Deb Moffitt
1418 South Houser, 52761

Ottumwa | 641-682-8357

Manager: Gary French
420 Gateway Drive, 52501

Pella | 641-620-1406

Mike Dabb
208 SE 9th Street, 50219

Red Oak | 712-623-4841

Manager: Amy Iles
1949 G Avenue, 51566

Spirit Lake | 712-336-0787

Manager: Ryan Summers
3010 18th Street, 50219

Waterloo | 319-236-1511

Manager: John Piazza
3338 West Airline Highway, 50703

Waukee | 515-987-2802

Manager: Clint Rees
920 SE Frontier Avenue, 50263



Table of Contents

Air Treatment & Filters

Air Cleaners.....	1
Air-to-Air Heat Exchangers.....	7
Humidifiers/Dehumidifiers.....	13
Permanant Filters.....	18
Throwaway Filters.....	19

Cooling - Equipment & Rooftop Units

Air Handlers.....	26
Electric Heat Kits.....	29
Coils.....	30
Condensing Units.....	40
Heat Pumps.....	46
Mini-Split Components & Accessories.....	49
Mini-Splits/Multi Zone Systems.....	54
Mini-Splits/Single Zone Systems.....	58
Packaged Terminal Air Conditioners.....	65
Roof Top Units.....	68
VRF Equipment.....	75

Cooling - Accessories

Brass Sealing Caps.....	79
Chemicals.....	80
Condensate Neutralizers.....	87
Condensate Drain Guns.....	88
Condensate Drain Pan Switches.....	89
Condensate Traps.....	90
Secondary Drain Pans.....	92
Condenser Pads.....	93
Sensing Bulbs.....	97
Defrost Controls.....	98
Electrical.....	102
Crankcase Heaters.....	108
Filter Driers.....	109
Leak Detection.....	114
Linesets.....	122
Mounting Systems.....	124
Refrigerant Components.....	125
Site Glasses.....	127
Tap Valves & Piercing Valves.....	129



Table of Contents

Ducts, Fittings & Accessories

Aluminum Faced Board Panning & Grille Frames.....	130
Canvas Duct Connectors.....	131
Duct Boosters.....	132
Duct Tape.....	134
Duct Fasteners.....	137
Duct Hangers.....	142
Duct Sealants.....	143
Flexible Duct.....	144
Galvanized Sheet Metal.....	149
Oval Pipe & Fittings.....	152
Plenum & Return Air Drops.....	154
PVD/PVC Air Duct & Sheets.....	156
PVD/PVC Air Duct Fittings.....	157
Rectangular Collars.....	159
Rectangular Duct.....	161
Rectangular Elbows.....	163
Rectangular Miscellaneous.....	167
Round Boots.....	172
Round Collars.....	176
Round Elbows.....	181
Round Pipe.....	183
Round Takeoffs.....	185
Round Tees & Wyes.....	188
Round Miscellaneous.....	190
Spiral Pipe & Fittings.....	194
Wall Stack Duct.....	200
Wall Stack Fittings.....	202

Fire Safety

Fire Safety.....	204
------------------	-----

Geothermal Equipment

Hydron Module.....	205
--------------------	-----

Geothermal Supplies

Geothermal Accessories.....	210
-----------------------------	-----



Table of Contents

Grilles & Registers

Deflectors.....	216
Ceiling Grilles & Registers.....	217
Commercial Grilles & Registers.....	220
Floor Grilles & Registers.....	223
Grille & Register Accessories.....	225
Sidewall Grilles & Registers.....	226

Heating - Forced Air

Furnace Accessories.....	229
Gas Fireplaces.....	231
Gas Downflow Furnaces.....	232
Gas Downflow/Horizontal Furnaces.....	237
Gas Multi-Position Furnaces.....	239
Gas Upflow/Horizontal Furnaces.....	241
Gas Unit Heaters.....	250
Kickspace Heaters.....	251

Heating - Hydronic

Maxifold Manifolds & Accessories.....	252
Navien Boilers.....	253
Rinnai Boilers.....	254
Thermolec Boilers.....	255
Triangle Tube (Prestige) Boilers.....	256
Weil McLain Boilers.....	258
Uponor (Wirsbo) Heating.....	262
Watts Heating.....	271

Heating - Hydronic Accessories

Air Purgers.....	272
Air Vents.....	273
Antifreeze & Other Chemicals.....	279
Aquastats.....	284
Baseboard Radiation.....	287
Boiler & Zone Controls.....	288
Boiler Accessories.....	294
Circulator Pumps.....	296
Flow Valves.....	302
Heat Exchangers.....	303



Table of Contents

Heating - Hydronic Accessories (Continued)

Isolation Flanges.....	305
Low Water Cut-Offs & Feeders.....	308
Pressure Reducing Valves.....	312
Radiator Traps & Valves.....	315
Spiralink Couplings.....	319
Thermal Expansion Tanks.....	320
Water Gauges & Sight Glasses.....	322
Zone Valves.....	325

Heating - Infrared

Reznor Infrared Accessories.....	329
Schwank Infrared Heating.....	330

HVAC - General Accessories

Adjustable Pressure Switches.....	332
Capacitors.....	333
Chemicals.....	341
Condensate Pumps.....	343
Disconnects/Fuses/Electrical Box Covers.....	349
Electrical Tape.....	352
Gas Valves.....	355
Heat Shrink Tubing.....	361
Igniters.....	362
Limit Controls.....	364
Oil Furnace Accessories.....	365
Pilot Assemblies.....	369
Pressure Regulators - Gas.....	370
Relays.....	372
Smoke Bombs.....	373
Spades & Other Electrical Connectors.....	374
Temporary Construction Thermostats.....	379
Thermocouples.....	381
Thermostats: ecobee.....	384
Thermostats: Honeywell.....	385
Thermostats: Pro1.....	400
Thermostats: Protech.....	403
Thermostats: Ruud.....	405
Thermostats: White-Rodgers.....	406
Thermostat Wire.....	407



Table of Contents

HVAC - General Accessories (Continued)

Transformers.....	409
Universal Ignition Modules.....	413
Wire Nuts & Leads.....	416
Wire Ties & Connectors.....	417
Vibration Pads.....	418
Zone Dampers & Accessories.....	419

Insulation

Adhesives & Coatings.....	424
Duct Liner.....	425
Duct Wrap.....	427
Fiberglass Pipe Insulation.....	428
Insulation Tape.....	429
Mechanical Fasteners.....	433
R-Foil Insulation.....	435
Rubber Pipe Insulation.....	437

Cleaners & Lubricants

Cleaners.....	438
Lubricants.....	442

Radon Equipment & Supplies

Sumps - Pits & Septic Tanks.....	447
Radon Pits and Lids.....	448

Repair Parts

American Standard Repair Parts.....	450
Basco Repair Parts.....	451
Bell & Gossett Repair Parts.....	452
Bradley Washfountain Repair Parts.....	454
Chicago Faucet Repair Parts.....	455
Dearborn Brass Repair Parts.....	458
Delta Faucet Repair Parts.....	459
Elkay Repair Parts.....	475
Empire Comfort Repair Parts.....	477
Fenner Drives Repair Parts.....	478
Franklin Electric Repair Parts.....	479
General Filter Repair Parts.....	480



Table of Contents

Repair Parts (Continued)

Gerber Repair Parts.....	481
Hi-Velocity (Energy Savings Products) Repair Parts.....	482
Hydron Module Repair Parts.....	483
Honeywell Repair Parts.....	484
Jones Stephens Repair Parts.....	487
Kohler Repair Parts.....	488
Malco Repair Parts.....	500
McDonnell & Miller Repair Parts.....	501
Moen Repair Parts.....	502
EL Mustee Repair Parts.....	506
Navien Repair Parts.....	507
Reznor Repair Parts.....	508
Rinnai Repair Parts.....	511
Ruud Water Heater Repair Parts.....	513
Schwank Repair Parts.....	518
Sloan Repair Parts.....	519
Speakman Repair Parts.....	527
T & S Brass Repair Parts.....	528
Taco Repair Parts.....	529
Thermolec Repair Parts.....	530
Triangle Tube Repair Parts.....	531
Union Brass Repair Parts.....	532
Ruud Heating & AC Repair Parts.....	533
Water Right Repair Parts.....	560
Watts Regulator Repair Parts.....	561
Weil McLain Repair Parts.....	562
Westinghouse/Philco Repair Parts.....	567
Woodford Repair Parts.....	570
Zoeller Repair Parts.....	573

Tools

Drill Bits.....	574
Flaring Tools.....	588
Flashlights.....	591
Hammers.....	598
Hand Sewer Machines.....	600
Hole Saws.....	607
HVAC Testing Tools.....	615
Knives & Replacement Blades.....	625



Table of Contents

Tools (Continued)

Levels.....	632
Miscellaneous Tools.....	637
Pipe Cutters - Copper.....	657
Pipe Cutters - PEX.....	663
Pipe Cutters - Plastic.....	664
Pipe Cutters - Soil Pipe.....	670
Pipe Cutters - Steel.....	671
Pipe Taps.....	673
Pipe Threaders.....	675
Pliers & Wire Strippers.....	678
Power Sewer Machines.....	687
Power Tools.....	690
Refrigeration Tools.....	723
Rulers & Tape Measures.....	732
Saws & Blades.....	736
Screwdrivers & Bits.....	754
Sheet Metal Tools.....	772
Shovels.....	783
Trouble Lights/Extension Cords.....	785
Wrenches.....	789

Venting

Aluminum Venting.....	803
Chimney Liners.....	805
Draft Diverters.....	806
Dryer Venting.....	807
Exhaust Fans.....	809
Outside Air Venting.....	815
Plastic High Temperature Sealants.....	816
Power Venters.....	818
QC Round Venting.....	819
RV Round Venting.....	820
Stainless Steel All Fuel Venting.....	822
WV Oval Venting.....	824
Roof & Chimney Caps.....	825
Stainless Steel Venting.....	826

Work Wear

Gloves, Ear Plugs, Goggles, ETC.....	827
--------------------------------------	-----



Table of Contents

Work Wear (Continued)

Work Gear.....	834
Heated Gear.....	835
Safety Glasses.....	839
Shoe Covers.....	842

Air Cleaners

Air Cleaners

F100 Media Air Cleaner

- High efficiency media filter captures particles as small as 0.3 microns
- Applicable to all gas, oil and electric forced air furnaces and to compressor cooling up to 5 tons
- Mounts in the return air duct
- Rugged zinc-coated, roll-formed cabinet resists corrosion
- Requires no electrical connections
- Mounts in any position
- Requires no maintenance except periodic media filter replacement
- Quick and easy media filter replacement



Air Treatment & Filters

Part #	Mfg #	Description	Price
186814	F100F2010	Media Air Cleaner, 20" x 25" x 4", MERV11	

F300 Electronic Air Cleaner

- Media post-filter provides enhanced filtration on select models
- Solid state power supply is self-regulating and maintains peak efficiency during a wide range of cell dirt loading conditions
- Low-profile door with test button to check system operation
- Helps filter efficiency-robbing "gunk" before it coats critical system parts
- Very low pressure drop
- Exclusive 10-year Clean Coil Guarantee
- Rugged zinc-coated, roll-formed cabinet provides superior strength and corrosion protection



Part #	Mfg #	Description	Price
174188	F300E1019/U	Electronic Air Cleaner, 16"x25" w/ Performance Enhancing Post-Filter	
174189	F300E1027/U	Electronic Air Cleaner, 20"x20" w/ Performance Enhancing Post-Filter	

Ultraviolet Air Treatment

UV Air Purifier with AirBRIGHT Odor Absorption

- installed in the ductwork of your central air system and is designed to help reduce airborne odors, toxic chemical vapors, germs and mold in your home
- Lamp is Always On
- Replace Lamp Annually
- AirBRIGHT Odor Absorber never needs replacing
- SnapLamp™ features replacement lamp handle with detachable replacement lamp.
- Universal Installation with a single product
 - UV Only
 - UV + Odor Removal
 - Internal Mount
 - External Mount



Part #	Mfg #	Description	Price
163862	UV2400U5000	24V UV Air Purifier with AirBRIGHT Odor Absorption	

Air Cleaners

Sail Switches

S688 Sail Switch

- Used in forced air systems to activate electronic air cleaners, humidifiers or other auxiliary equipment in response to air flow from system fan
- Polyester film sail mounted on a micro switch snap switch
- SPDT Switching
- Top and bottom conduit knockouts for wiring convenience
- Low air velocity switch operation makes at 250 fpm and breaks at 75 fpm



Air Treatment & Filters

Part #	Mfg #	Description	Price
006785	S688A1007	5" Wide Sail, 26.2 sq in of Area, 10" Insertion Length	

Air Cleaners

Air Cleaners

Ruud Media Air Cleaner

- Fits a wide variety of equipment
- Platinum metallic paint
- Rugged cabinet construction



Part #	Mfg #	Description	Price
086516	84-25050-01	O/A Dimension: 20-1/4"H x 24-7/8"D x 7-1/8"W MERV8 2000 cfm	
035230	84-25050-03	O/A Dimension: 23-1/2"H x 25-5/8"D x 15-1/2"W, Right Angle	
088498	84-25050-06	O/A Dimension: 16-1/4"H x 24-7/8"D x 7-1/8"W MERV8 1400 cfm	

IAQ Chemicals

ClenAir Gel Tub

- Place open tub in HVAC ductwork or in room near source of odor
- Available in regular or cherry



Part #	Mfg #	Description	Price
041980	851500	1/2 lb Clenair Gel Tubs	
042554	851501	1 lb Clenair Gel Tubs	
042555	85-1503	3 lb Clenair Gel Tubs	

Air Treatment & Filters



Air Cleaners

Air Cleaners Media Air Filter

Part #	Mfg #	Description	Price
042237	84-16X20-1	16" x 20" x 1", Polarized	
042238	84-16X25-1	16" x 25" x 1", Polarized	
045033	84-20X20-1	20" x 20" x 1", Polarized	
042239	84-20X25-1	20" x 25" x 1", Polarized	
109749	84-28X32-1	28" x 32" x 1"	
099418	84-28X36-1	28" x 36" x 1"	

Filter Base - ACG Series

- Uses standard filter sizes
- Gasketed door
- Fully insulated
- Upflow with hinged door



Part #	Mfg #	Outside Dim (W x L x H)	Price
077769	54-1625-G6	17-3/8" x 28-1/2" x 5-3/4"	

Air Treatment & Filters

UV Air Cleaners

Ultraviolet Air Disinfection Systems

UltraMAX™ UMX Remote UV Lamp Series with UltraVation® T3™

- T3™ is a patented lamp system that maximizes performance, safety and economy
- Unique interlock that safely turns off UV before lamp removal



Part #	Mfg #	Description	Price
112482	UMX-2412-EZ	(1) 12" Enhanced High Output UV Lamp	

UltraMAX™ UME Single Remote UV Lamp Series with UltraVation T3™

- T3™ is a patented lamp system that maximizes performance, safety and economy
- Unique interlock that safely turns off UV before lamp removal



Part #	Mfg #	Description	Price
125775	UME-1900T	(1) 17" 110V Remote Mount UV Lamp with Odor Control	
125781	UME-1902T	(2) 17" 110V Remote Mount UV Lamp with Odor Control	

UV Replacement Lamps



AS-IH-1001



LPPP-0002



AS-IH-1003

Part #	Mfg #	Description	Fits Model	Price
112052	AS-IH-1001	12" T3 Remote UV-C Lamp		
060697	LPPP-0002	16" "U" Shaped UV Lamp	UME-1036, 2036 UVS-1036, 2036 UVE-1036, 2036	
126917	AS-IH-1003	17" UV, UV-C Lamp	All UltraMax, UVS, UVE Germicidal UV Series, and Phototronic Air Cleaner Models	

Air Treatment & Filters

UV Air Cleaners

Air Purifiers

P900GX Portable UV Air Purifier

- Dual zone 19mm UVC/UVV Quartz lamp destroys biological and chemical contaminants
- 9 Electronically controlled speeds
- Touch-pad digital controls with count-down timer
- Purifies up to 900 square feet
- 85 Watts
- Weight: 11 lbs
- Includes integral stand and handle
- Wall mountable
- 3-Year warranty on parts including UV lamp

Part #	Mfg #	Description	Price
141942	P900GX	Dual UVC/UVV Air Purifier	

Sanuvox R+ In-Duct UV Air Purification System

- Whole-home system designed to destroy viruses, bacteria, mold, chemicals, odors, allergens and VOCs
- High-intensity UV 'J' lamp (18" arc length), turbulator and reflecting chamber parallel to the airflow
- Microprocessor controlled for automatic operation
- UV Chamber rotates 360° for up or down-flow systems
- Fiber board kit included
- 3-Year warranty including UV lamp



Part #	Mfg #	Description	Price
139088	R PLUS +	In-Duct UV Whole-Home Air Purification System	

UV Replacement Bulbs

T6 Dual Zone High Intensity Replacement Lamp

- UVC/UVV Germicidal/oxidizing

Part #	Mfg #	Description	Price
141941	LMPHGJ105	10.5" UV J Lamp for R4000GX, S30HFX	

Air Treatment & Filters

Air-to-Air Heat Exchangers

Heat Recovery Ventilators

MAX Series Residential HRV

- 5-Speed electronics
- Lifestyle MAX digital control included
- Compact electrically powered
- Aluminum heat exchange core
- Built-in dehumidistat
- Easy installation
- Increases air exchange rate when humidity rises
- Easy clean filters
- Quiet and reliable five speed motor
- 5-Year warranty on parts, lifetime on heat exchange core



95MAX



155MAX



200MAX

Part #	Mfg #	Dimensions H x W x D	Defrost Type	Electrical	CFM @ 0.1" ESP	Ship Wt	Price
033812	95MAX	24-1/2" x 18-1/2" x 16"	Recirculating	120-1-60	76	56 lbs	
027707	155MAX	19" x 33-5/8" x 14-3/4"	Damper	120-1-60	144	73 lbs	
033813	200MAX	19" x 33-5/8" x 14-3/4"	Recirculating	120-1-60	207	73 lbs	

RNC Series Residential HRV

- 2-Speed electronics
- Each air stream has one centrifugal blower driven by a common PSC motor
- Compact electrically powered
- Patented aluminum core
- Built-in dehumidistat
- Built-in relay for interfacing to furnace
- Damper defrost system
- Cross-flow heat recovery core transfers heat between two air streams, removable for cleaning
- Washable air filters
- Suffix: DX = with 99-DX01 digital control
- 5-Year warranty on parts, lifetime on heat exchange core



RNC200

Part #	Mfg #	Dimensions H x W x D	Defrost Type	Electrical	CFM @ 0.1" ESP	Ship Wt	Price
188379	RNC-155BC02	19" x 33-5/8" x 14-3/4"	Recirculating	120-1-60	144	67 lbs	
188380	RNC-200BC02	19" x 33-5/8" x 14-3/4"	Recirculating	120-1-60	207	67 lbs	

Air-to-Air Heat Exchangers

Turbulent Flow Precipitators Whole House Air Cleaner

- Removes close to 99.4% of coarser particles such as pollen, fungus spores, dust, animal dander and dirt
- Removes close to 90% of tobacco smoke and wood smoke particles and some bacteria
- Filters down to 1/10 of a micron
- Motor: 2-speed, high efficiency PSC motor
- Filters: (1) replaceable TFP collector and (1) replaceable HEPA filter



Turbulent Flow Precipitators Parts

Part #	Mfg #	Description	Price
118135	65-502R	(1) Replacement HEPA Filter	
080808	65-503R	(1) Replacement TFP Collector	

Indoor Pool and Spa Heat Recover Ventilators

- Controls humidity in wet areas such as pools, spas, whirlpools, saunas, and personal gyms



Part #	Mfg #	Description	Price
077178	700 DD POOL	(2) Air Stream Sections: Each w/PSC, 3-Speed, Sngl Shaft, 120VAC, 4.5A, 1/4 hp, 1450 rpm Motor	

Optional Remote Controls Digital Electronic Timers

- Can be mounted up to 60' from HRV
- Can override the base module and activate high speed operation
- Easy to install and operate
- Works well in bathrooms, laundries, and other high moisture areas
- Touch pad operation
- Childproof lockout feature
- 20/40/60 Minute status lights
- 60' (18 m) maximum wire length only, may be wired in parallel if no other controls are used



Part #	Mfg #	Connects To	Color	Price
039208	99-107W	Cover Plate for 99-104	White	

Timers Crank Timer

Part #	Mfg #	Description	Color	Price
030653	99-101	Rotate the Dial for up to 60 Minutes of High Speed Operation	White	

Air-to-Air Heat Exchangers

Lifestyle Controls and Timers

Lifestyle MAX Programmable Control

- Fully-featured, 5-speed operation
- (4) User selectable operational modes (not available on all models)
- Built-in interface to furnace
- Automatic service reminder
- Automatic control based on outdoor temperature sensing
- Easy-to-read, backlit LDC screen
- Automatic dehumidistat disable
- Optional upgrade



Part #	Mfg #	Description	Color	Price
125853	99-LS01	(4) User Selectable Modes, 5-Speed Operational Control	White	

Lifestyle RNC Digital Control

- (4) Selectable operational modes (not available on all models)
- 2-Speed operation on each mode
- Adjustable dehumidistat function
- Dehumidistat disable
- Optional on RNC



Part #	Mfg #	Description	Color	Price
125854	99-DX01	Adjustable Digital Dehumidistat RNC Control	White	

Lifestyle RNC Dehumidistat

- Initiates high speed when the indoor humidity level is above the setpoint
- Optional on RNC



Part #	Mfg #	Description	Color	Price
125855	99-DH01	RNC Series Dehumidistat	White	

Lifestyle RNC Ventilation Control

- 2-Speed operation
- Standby
- Dehumidistat
- Optional on RNC



Part #	Mfg #	Description	Color	Price
125856	99-BC01	RNC Series Ventilation Control	White	

Air-to-Air Heat Exchangers

Lifestyle Control

- 5-Speed, (4) modes of operation
- 24/7 Programmable ventilation
- (4) Programmable events per day (wake, leave, arrive, sleep)
- Easy to program
- Electronic dehumidistat
- Easy to read LCD screen



Part #	Mfg #	Description	Color	Price
119013	99-350	Programmable Ventilation Control	White	

Lifestyle 20/40/60 Minute Timer

- Initiates high speed operation for 20, 40, or 60 minutes
- Compatible with MAX and RNC Series



Part #	Mfg #	Description	Color	Price
125858	99-DET01	20/40/60 Minute Timer	White	

Lifestyle Timer

- Available on MAX and RNC Series

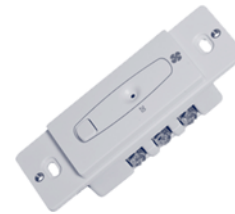

Part #	Mfg #	Description	Color	Price
125859	99-20M01	Initiates High Speed Operation for 20 Minutes	White	

Lifestyle RNC Remote Dehumidistat

- Detects increasing humidity and controls it by boosting rate of ventilation
- For use in kitchen, bathroom, spa or swimming pool or anywhere humidity is a concern
- 2 Wire low voltage control device



Part #	Mfg #	Description	Connects To	Color	Price
028792	99-116	Remote Vent Control w/HRV System Switch	Black & Red Terminals	White	

Dampers

Part #	Mfg #	Description	Price
092347	99-RSK6	6" Spring Loaded Damper	

Air Treatment & Filters

Air-to-Air Heat Exchangers

Weatherhood Kits

- Ideal for HRV/ERV and in-line applications
- High density polyethylene for a durable, long life even in severe climate
- No moving parts, eliminates freezing or sticking potential
- Includes:
 - (2) Hoods
 - 12" Wall sleeve
 - Duct collar
 - Insect/animal screens



Part #	Mfg #	Size	Color	Price
027708	99-186	6" Diameter	White	
028790	99-187	7" Diameter	White	

Dual Vent Hoods

- Requires only (1) 6" opening for intake/exhaust
- Damage-resistant metal construction for exterior wall connection
- Durable rigid plastic
- Suitable for 5" or 6" connections
- Maximized airflow with lower pressure drop
- Fire-rated, UV-resistant materials
- Ideal for space-constrained HRV or ERV applications
- Includes:
 - Hood assembly
 - Duct splitter
 - Duct insulator (2 pieces)
 - Retainer screw assembly
 - Nylon cable tie
 - Screen



Part #	Mfg #	Description	Color	Price
141190	99-190	Fully Adjustable Thermal Insulation	White	

Accessories

Part #	Mfg #	Description	Price
072015	65-160	Foam Filter	
037748	99-110	HRV/TFP/CAF Interface Relay Kit	
039207	99-201	60' of 20 Gauge 5-Wire for 99-104 Timer	
052100	99-275	Circuit Board & Control Pad - Controlair15	

Optional 3-Speed Control

- 3-Speed high/medium/high
- On/off
- 4-Wire, 20 gauge wire

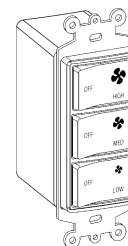

Part #	Mfg #	Description	Price
077599	99-500	3-Speed Control	

Air-to-Air Heat Exchangers

Ventilation

TrueFRESH Energy Recovery Ventilator

- TrueFRESH eliminates the need for overhead ducting, and balance without adjusting dampers, they change everything when it comes to time consuming installation
- Removable duct collars
- Damperless balancing
- Adjustable hanging straps
- Centralized wiring and speed control
- Customizable
- Compact size
- Meets ASHRAE 62.2 standards
- 5-Year warranty



Air Treatment & Filters

Part #	Mfg #	Description	Price
152253	VNT5200E1000U	200 cfm Energy Recovery Ventilator, 120 VAC, 60 Hz	

Humidifiers/Dehumidifiers

Humidifiers

TrueEASE™ Flow-Through Humidifier

- Up to 30% water savings, up to 50% water savings with fan-powered model
- PerfectFLO™ water distribution tray
- Common-sense interface
- AglON® humidifier pads with anti-microbial coating
- User-friendly pad access
- Interchangeable bypass
- Integrated wiring and quick-connect plumbing
- Includes humidifier, saddle valve, water supply line, 10' drain hose, H8908 manual humidity control, hardware, mounting template and owner's manual



Advanced Bypass



Fan-Powered

Air Treatment & Filters

Part #	Mfg #	Description	Output	Price
134722	HE100A1000	Bypass Small Basic	12 gpd	
134723	HE150A1005	Bypass Small Advanced	12 gpd	
134724	HE200A1000	Bypass Large Basic	17 gpd	
134725	HE250A1005	Bypass Large Advanced	17 gpd	
134726	HE300A1005	Fan-Powered Advanced	18 gpd	

Electrode Humidifier

- Includes:
 - HumidPRO™ H6062 digital humidity control
 - Distribution Kit HM700ACL Y2
- Auto-adaptive technology adjusts for changes in the weather, water and voltage
- Automatically protects against window condensation and frost
- Humidity Boost can be used to increase relative humidity by 5 or 10%
- Easy to use with any of the control options
- When used with Prestige IAQ and VisionPRO 8000 thermostats, the humidifier communicates with the wireless outdoor sensor to make automatic humidity adjustments



Part #	Mfg #	Description	Price
185465	HM700A1000	Electrode Steam Humidifier	11 or 22 gpd

Humidifier Replacement Pads



HC22A

Part #	Mfg #	Description	Price
030568	HC22A1007	HE220 Pad for HE220, HE225, Aprilaire 110,220,550,558	
034029	HC26A1008	HE260, HE360 Pad for HE260, HE265, HE360, HE365, Aprilaire 350,360,560,568, 600,700,760,768	
146138	HC22E1003	HE225 Pad with AGION™ Coating for HE220, HE225, Aprilaire 110,220,550,558	

Remote Mount Kit

Part #	Mfg #	Description	Price
111236	50024917-001	10' Remote Mount Kit for All TrueSTEAM Humidifiers	
111237	50024917-002	20' Remote Mount Kit for HM512 and HM509R TrueSTEAM Humidifiers	

Humidifiers/Dehumidifiers

Air Treatment & Filters

Humidifiers (Continued)
Remote Mount Kit

Part #	Mfg #	Description	Price
185466	HM700ADISTKIT/ U	5' Stainless Steel Remote Mount Kit for H6062 HumidPRO™ Humidifier	

Humidity Controllers

H1008 Automatic Humidity Controller

- Provides automatic control for by-pass, flow-through, powered flow-through, steam and drum humidifiers in central heating systems
- Patented Honeywell HumidiCalc+™ software
- Combination temperature and humidity sensor
- Automatically adjusts humidity level based on frost factor set by user
- Duct-mounted
- System status light indicates normal operation, test mode and fault



Part #	Mfg #	Description	Price
037361	H1008A1008	Humidifier, 95% RH@95°F (Non-Condensing), Dew Point Control	

H8908 Humidistat/Dehumidistat

- Provides automatic low voltage control of humidifier and dehumidifiers or ventilators
- SPST, snap-acting, dust-proof switch designed for wall or surface duct mounting
- Positive on and off settings
- 12" Moisture sensitive nylon ribbon wound around three bobbins effectively gives optimum control for reliable operation under changing ambient conditions



Part #	Mfg #	Application	Color	Price
111239	H8908ASPST	Humidification	White	
134079	H8908DSPST	Dehumidification	White	

H6062 HumidPRO™ Digital Humidity Control

- Automatic humidification (window protection) with included outdoor sensor
- Manual humidification control
- Manual dehumidification control
- Dehumidifier compressor protection
- Large, digital backlit display
- Simple, intuitive programming
- RH% and outdoor temperature calibration
- Adjustable high and low range stops (10-90%)
- Automatically detects presence of outdoor sensor to set control to Automatic or Manual Mode



Part #	Mfg #	Description	Price
171473	H6062A1000	Manual Mode: 10% to 90% RH% (Adjustable) Auto Mode: 10% to 60% RH% (35% Default)	

Humidifiers/Dehumidifiers

Power Humidifiers - Drain Type

1042 Legacy Series - By-Pass Flow-Through Power Humidifier

- *Installs on vertical warm air supply or cold air plenum*
- *6" Diameter side bypass duct (collar supplied)*
- *Plenum opening: 10-1/4"W x 9-1/2"H*
- *Replacement filter: 990-13 evaporator pad*
- *Order 1/4" tubing separately*
- *5-Year limited warranty*



Part #	Mfg #	Description	GPD	Unit Size	Electrical	Price
004860	1042LH	Recirculating Type, MHX3 Humidistat	19.2	11-1/2" x 15" x 9"	115V/60Hz	

Air Treatment & Filters

Humidifiers/Dehumidifiers

Humidifier Parts & Accessories
Evaporator Pads



84-25055-01

Air Treatment & Filters

Part #	Mfg #	Description	Price
089995	84-A97	Autoflo Drum Type Evaporator Pad	
090002	84-4EP	Autoflo Metal Evaporator Pad	
059586	84-25055-01	9"x14"x2" Evaporator Pad	
044159	84-25055-02	9"x11"x2" Evaporator Pad	

Humidifiers/Dehumidifiers

Dehumidifiers

TrueDRY DH65 Whole-House Dehumidifier

- Removes up to 65 pints of water from the indoor air
- Built-in humidity control requires no additional wiring to an external control
- Choice of external control options also available for centrally ducted control
- Feedback on operation and maintenance provided via intuitive on-board LED light interface
- MERV 11 Filtration



Part #	Mfg #	Description	Price
148234	DR65A2000	8" Diameter Plenum Opening w/o Controls Uses R-410A Refrigerant	

TrueDRY DR90 Whole-House Dehumidifier

- Removes up to 90 pints of water from the indoor air
- Built-in fresh air supply
- Uses only 6.7 amps for energy efficiency
- MERV 11 Filtration
- R-410A compliant
- 5-Year warranty
- Energy Star® rated



Part #	Mfg #	Description	Price
131281	DR90A2000	10" Plenum Opening with 6" Ventilation Collar, less Control	

Air Treatment & Filters

Permanant Filters

Permanant Filters

Red Label Permanent Air Filters

- Peak dust arrestance is 82%
- Dust holding capacity: 147 gm



Air Treatment & Filters

Part #	Mfg #	Size	Price
196043	AFR12121	12" x 12" x 1"	
195136	AFR14141	14" x 14" x 1"	
194763	AFR14251	14" x 25" x 1"	
197680	AFR16382112 1	163/8" x 211/2" x 1"	
193806	AFR16251	16" x 25" x 1"	
194766	AFR20201	20" x 20" x 1"	
195306	AFR20241	20" x 24" x 1"	
194767	AFR20251	20" x 25" x 1"	

Throwaway Filters

Z-Line Pleated Series Filters

- Ideal in high velocity systems where maximum square footage of media is necessary
- Features 100% synthetic fibers laminated to galvanized metal backing
- Designed to be utilized as either pre-filters or primary filters in virtually every commercial, industrial, and residential HVAC application

1" ZL Z-Line Series Pleated Filter

- MERV 7
- 100% Synthetic, charged media



Part #	Mfg #	Size	Price
102089	ZLP10201	10" x 20" x 1"	
102091	ZLP12201	12" x 20" x 1"	
102092	ZLP12241	12" x 24" x 1"	
102094	ZLP14201	14" x 20" x 1"	
042535	ZLP14251	14" x 25" x 1"	
112438	ZLP14301	14" x 30" x 1"	
102095	ZLP15201	15" x 20" x 1"	
035858	ZLP16201	16" x 20" x 1"	
102093	ZLPSP1E	16" x 22" x 1"	
036832	ZLP16251	16" x 25" x 1"	
110862	ZLP18181	18" x 18" x 1"	
070781	ZLP18201	18" x 20" x 1"	
109164	ZLP18241	18" x 24" x 1"	
038324	ZLP20201	20" x 20" x 1"	
102099	ZLP20241	20" x 24" x 1"	
038325	ZLP20251	20" x 25" x 1"	
115791	ZLPSP22D29H1	22.25" x 29.5" x 1"	
102096	ZLP24241	24" x 24" x 1"	
053645	ZLP25251	25" x 25" x 1"	
115787	ZLPSP27M31M1	27-3/4" x 31-3/4" x 1"	
115788	ZLPSP27M35M1	27-3/4" x 35-3/4" x 1"	
131831	ZLPSP1K28341	28" x 34" x 1"	
115793	ZLPSP28D30H1	28.25" x 30.5" x 1"	
121768	ZLP30361	30" x 36" x 1"	
115794	ZLPSP30B32H1	30.125" x 32.5" x 1"	

2" ZL Z-Line Series Pleated Filter

- MERV 7
- 100% Synthetic, charged media



Part #	Mfg #	Size	Price
031788	ZLP16202	16" x 20" x 2"	
027336	ZLP16252	16" x 25" x 2"	
047466	ZLP18182	18" x 18" x 2"	
030585	ZLP20202	20" x 20" x 2"	
034676	ZLP20252	20" x 25" x 2"	
094283	ZLP24242	24" x 24" x 2"	
040794	ZLP25252	25" x 25" x 2"	

4" ZL Z-Line Series Pleated Filter

- MERV 7
- 100% Synthetic, charged media



Part #	Mfg #	Size	Price
083372	ZLP16204	16" x 20" x 4"	
063647	ZLP16254	16" x 25" x 4"	
071312	ZLP20204	20" x 20" x 4"	
023474	ZLP20254	20" x 25" x 4"	
050395	ZLP24244	24" x 24" x 4"	

Z-Line Series Media Replacement Filters

Z-Line Series 500AB and 300AB Air Cleaner Media

- Replacement options for Trion Air Bear® and Air Cub® filters
- 100% Synthetic, charged media



Part #	Mfg #	Size	Price
102417	ABP20255	20" x 25" x 5"	

Throwaway Filters

Filter Pads & Bulk Media

- *UL Class 2*

FSR Fiberglass Service Roll



Part #	Mfg #	Size	Price
004334	FSR30201	30" x 20' x 1"	
004336	FSR36201	36" x 20' x 1"	

Air Treatment & Filters

Throwaway Filters

Carbon Media Filters

- *MERV 13*
- *Activated carbon core*
- *Rated life cycle: 30 - 90 days*



Replacement Carbon Media Filter Pad

Part #	Mfg #	Size	Qty	Price
109748	C3P2832	28" x 32"	3/Pk	
099419	C3P2836	28" x 36"	3/Pk	



Throwaway Filters

Disposable Media Filters

Filter Media

Part #	Mfg #	Description	Price
045070	54-25051-02	Filter Media 3"	

Media Air Filter

Part #	Mfg #	Description	Price
131298	540013	4-1/2" 2,000 CFM	

Air Treatment & Filters

Throwaway Filters

Air Filters
Media Air Filters



Part #	Mfg #	Description	Price
062226	54-14X25-R	14" x 25", 3/Pk	
042240	54-16X20-R	16" x 20", 3/Pk	
042241	54-16X25-R	16" x 25", 3/Pk	
048021	54-20X20-R	20" x 20", 3/Pk	
042242	54-20X25-R	20" x 25", 3/Pk	

Air Treatment & Filters

Throwaway Filters

Air Treatment & Filters

**Residential Media Air Cleaners
Pop-Up Replacement Media Air Filter**

- Stores flat and pops into shape for installation
- Store (5) pop-up filters in the space of (1) standard replacement cartridge
- Additional 1" of filtration depth compared to standard replacement cartridges
- No combs, pleat spacers or end caps



Part #	Mfg #	Size	Efficiency	Used With	Price
101237	POPUP2200	20-1/4" x 24-1/4" x 5-7/8"	MERV 11	Space-Gard® 2200	
103142	POPUP2400	26" x 27-1/8" x 5-7/8"	MERV 11	Space-Gard® 2400, Lennox PMAC12	

Residential Air Cleaner Replacement High Efficiency Media Filter



Part #	Mfg #	Size	Efficiency	Used With	Price
052258	FC100A1029	16" x 25"	MERV 10	F100, F200	
052773	FC100A1037	20" x 25"	MERV 10	F100, F200, SpaceGard 2200	

Throwaway Filters

High Efficiency Media Air Cleaners Replacement Filter Media



Part #	Mfg #	Description	Price
019291	12880	MERV 11 Replacement Media for Aprilaire 2200/2250	

Air Treatment & Filters



Air Handlers

Air Handlers

- 4-Way Convertible Upflow, Downflow, Horizontal Left and Horizontal Right Applications
- Factory-Installed Indoor Coil
- Field Installed Auxiliary Heater Kits Available



Warranties
10-Yr Parts Warranty

RH2T Two-Stage Air Handler - Constant Torque Motor (ECM) 230 Volt

Part #	Mfg #	Tons	Max Kw	CFM Lo	CFM Hi	H x L x W	Price
171738	RH2T2421MTANJA	2 Ton	10	525	700	42-1/2" x 21-3/4" x 21"	
171739	RH2T3621MTANJA	3 Ton	18	800	1050	50-1/2" x 21-3/4" x 21"	
171740	RH2T4824MTANJA	4 Ton	25	1050	1400	55-1/2" x 21-3/4" x 24-1/2"	
171741	RH2T6024STANJA	5 Ton	25	1200	1600	55-1/2" x 21-3/4" x 24-1/2"	

RH1T Single-Stage Air Handler - Constant Torque Motor (ECM) 230 Volt

Part #	Mfg #	Tons	Max Kw	CFM Lo	CFM Hi	H x L x W	Price
171725	RH1T2417STANJA	2 Ton	10	600	800	42-1/2" x 21-3/4" x 17-1/2"	
171727	RH1T3617STANJA	3 Ton	18	1,000	1,200	42-1/2" x 21-3/4" x 17-1/2"	
171729	RH1T3621MTANJA	3 Ton	18	1,000	1,200	50-1/2" x 21-3/4" x 21"	
171733	RH1T4821STANJA	4 Ton	25	1,400	1,600	50-1/2" x 21-3/4" x 21"	
171735	RH1T4824STANJA	4 Ton	25	1,400	1,600	50-1/2" x 21-3/4" x 24-1/2"	
171737	RH1T6024STANJA	5 Ton	25	1,800	-	55-1/2" x 21-3/4" x 24-1/2"	

RH1T Single-Stage Air Handler - Constant Torque Motor (ECM) 115 Volt

Part #	Mfg #	Tons	Max Kw	CFM Lo	CFM Hi	H x L x W	Price
171724	RH1T2417STANAA	2 Ton	10	600	800	42-1/2" x 21-3/4" x 17-1/2"	
171726	RH1T3617STANAA	3 Ton	18	1,000	1,200	42-1/2" x 21-3/4" x 17-1/2"	
171732	RH1T4821STANAA	4 Ton	25	1,000	1,400	50-1/2" x 21-3/4" x 21"	
171734	RH1T4824STANAA	4 Ton	25	1,600	-	50-1/2" x 21-3/4" x 24-1/2"	
176250	RH1T6021STANAA	5 Ton	25	1600	1725	57" x 21-3/4" x 21"	
171736	RH1T6024STANAA	5 Ton	25	1,800	-	55-1/2" x 21-3/4" x 24-1/2"	

RH1P Single-Stage Air Handler - (PSC Motor) 230 Volt

Part #	Mfg #	Tons	Max Kw	CFM Lo	CFM Hi	H x L x W	Price
171696	RH1P1817STANJA	1.5 Ton	10	600	800	42-1/2" x 21-3/4" x 17-1/2"	
171698	RH1P2417STANJA	2 Ton	10	600	800	42-1/2" x 21-3/4" x 17-1/2"	
171702	RH1P3617STANJA	3 Ton	18	1,000	1,200	42-1/2" x 21-3/4" x 17-1/2"	
171703	RH1P3621STANJA	3 Ton	18	1,200	-	42-1/2" x 21-3/4" x 21"	
171707	RH1P4821STANJA	4 Ton	25	1,600	-	50-1/2" x 21-3/4" x 21"	
171708	RH1P4824STANJA	4 Ton	25	1,600	1,800	55-1/2" x 21-3/4" x 24-1/2"	
171709	RH1P6024STANJA	5 Ton	25	1,600	1,800	55-1/2" x 21-3/4" x 24-1/2"	



Air Handlers

RH1P Single-Stage Air Handler - (PSC Motor) 115 Volt

Part #	Mfg #	Tons	Max Kw	CFM Lo	CFM Hi	H x L x W	Price
171695	RH1P1817STANAA	2 Ton	N/A	600	800	42-1/2" x 21-3/4" x 17-1/2"	
171697	RH1P2417STANAA	2 Ton	N/A	600	800	42-1/2" x 21-3/4" x 17-1/2"	
171699	RH1P3017STANAA	2.5 Ton	N/A	1,000	1,200	42-1/2" x 21-3/4" x 17-1/2"	
171701	RH1P3617STANAA	3 Ton	N/A	1,000	1,200	42-1/2" x 21-3/4" x 17-1/2"	
171705	RH1P4821STANAA	4 Ton	N/A	1,600	-	50-1/2" x 21-3/4" x 21"	

Cooling - Equipment & Rooftop
Units

Air Handlers

Horizontal Drain Kits

Part #	Mfg #	Description	Price
120459	920265	Horizontal Drain Kit C6 Coils 24-30	
120638	920266	Horizontal Drain Kit C6 Coils 36-42	
120639	920267	Horizontal Drain Kit C6 Coils 48-60	

Cooling - Equipment & Rooftop
Units

Electric Heat Kits

Electric Heat Kits

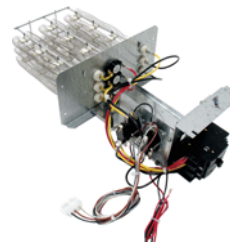

Electric Heat Kit for Air Handlers

Part #	Mfg #	kW Heat	Electrical	Size	Price
091408	RXBH-24A20J	20kW	208/240-1-60	3.5 - 5.0 Ton	
091409	RXBH-24A25J	25kW	258/240-1-60	3.5 - 5.0 Ton	
133871	RXBH-24A30J	30kW	208/240-1-60	3.5 - 5.0 Ton	
133869	RXBH-1724A05J	5Kw	208/240-1-60	1.5 - 5.0 Ton	
133433	RXBH-1724A07J	7kW	208/240-1-60	1.5 - 5.0 Ton	
133643	RXBH-1724A10J	10kW	208/240-1-60	1.5 - 5.0 Ton	
133644	RXBH-1724A15J	15kW	208/240-1-60	1.5 - 5.0 Ton	

Cooling - Equipment & Rooftop Units



Coils

Classic® Series MultiFlex® Indoor Coils

- Available in upflow, downflow, and horizontal configurations
- Patented single-row, single-coil pleated concept results in extremely low pressure drops and ease of cleaning
- Constructed of enhanced aluminum fins bonded to inner grooved copper tubing
- Front refrigerant and drain connections for ease of installation
- Coils have sweat fitting refrigerant connections
- Primary condensate drain connections 3/4" FNPT
- Internal check valves
- Double-wall construction offers sturdiness, dead air space insulation
- 5-Year warranty on all parts



Classic
SERIES

10 SEER Classic® Series Flow check Standard Cooling/Heat Pump Coil - RCBA

- X Suffix - Unit has insulation
- I Suffix - Revised horizontal with insulation

Part #	Mfg #	Type	Tons	Connection	Air Flow	Width	Price
055327	RCBA-2457GP	Uncased	1.5 - 2.0	Front	600 - 800 cfm	12-1/4"	
055328	RCBA-3765GP	Uncased	2.5 - 3.0	Front	1,000 - 1,200 cfm	15-3/4"	
055329	RCBA-4882GP	Uncased	4.0	Front	1,400 - 1,600 cfm	19-1/4"	
055330	RCBA-6089GP	Uncased	5.0	Front	2,000 cfm	22-3/4"	

Cooling - Equipment & Rooftop
Units

Coils

Achiever® Series Coils for Gas & Oil Furnaces

- Constructed of aluminum fins bonded to internally grooved copper tubing
- Coils are factory leak tested & have sweat refrigerant connections
- (2) Sets of 3/4" NPT condensate drain connections for easy connection
- Coils are ARI certified for system application with variety of Ruud Value Series outdoor units
- Condensate drain pan is constructed of high grade, heat resistant corrosion free thermal-set material
- Compatible with Germicidal Light System (UV resistant)
- Bi-directional airflow eliminates need to switch any internal components from horizontal left to right
- Universal duct flanges are included with all coil models
- Conditional parts warranty equal to limited parts warranty of outdoor model (registration required)
- 5-Year limited parts warranty



Cased



Uncased



18 SEER R-410A High Efficiency A/C or Heat Pump Multi-Position Coil for Gas & Oil Furnaces - RCFN

Part #	Mfg #	Type	Tons	Air-Flow CFM Range	Nominal Capacity BTUH	Face Area Sq Ft	Coil Size	Line Sets Liq, Suction	Ship Wt	Price
129888	RCFN-HM2417CC	Cased	2.0	600/800	24,000	5.70	17-1/2"	3/8", 3/4"	57 lbs	
129890	RCFN-HM2421CC	Cased	2.0	600/800	24,000	5.70	21"	3/8", 3/4"	60 lbs	
129891	RCFN-HM3624CC	Cased	3.0	825/1,175	36,000	9.98	24-1/2"	3/8", 7/8"	118 lbs	
129892	RCFN-HM4824CC	Cased	4.0	1,000/1,600	48,000	9.98	24-1/2"	3/8", 7/8"	118 lbs	
129893	RCFN-HM6024CC	Cased	5.0	1,050/1,700	60,000	9.98	24-1/2"	3/8", 7/8"	118 lbs	

16 SEER R-410A High Efficiency A/C or Heat Pump Multi-Position Coil for Gas & Oil Furnaces - RCFM

Part #	Mfg #	Type	Tons	Air-Flow CFM Range	Nominal Capacity BTUH	Face Area Sq Ft	Coil Size	Line Sets Liq, Suction	Ship Wt	Price
112102	RCFM-HM2421AC	Cased	2.0	600/800	24,000	5.70	21"	3/8", 3/4"	57 lbs	
112107	RCFM-HM6024AC	Cased	5.0	1,300/1,700	60,000	9.98	24-1/2"	3/8", 7/8"	118 lbs	

13-16 SEER R-410A A/C or Heat Pump Multi-Position Coil for Gas & Oil Furnaces - RCFL

Part #	Mfg #	Type	Tons	Air-Flow CFM Range	Nominal Capacity BTUH	Face Area Sq Ft	Coil Size	Line Sets Liq, Suction	Ship Wt	Price
090461	RCFL-HM2414AC	Cased*	1.5-2.0	600/1,000	18,000-24,000	4.56	14"	3/8", 3/4"	50 lbs	
090462	RCFL-HM2417AC	Cased	1.5-2.0	600/1,000	18,000-24,000	4.56	17-1/2"	3/8", 3/4"	51 lbs	
159504	RCFL-HM2514CC	Cased	2.0	600/1,000	18,000-24,000	4.56	14"	3/8", 3/4"	50 lbs	
140773	RCFL-HM2617CC	Cased	1.5-2.0	900/1,400	18,000-24,000	5.70	17-1/2"	3/8", 3/4"	57 lbs	
090464	RCFL-HM3617AC	Cased	2.5-3.0	900/1,400	30,000-36,000	5.70	17-1/2"	3/8", 3/4"	57 lbs	
090465	RCFL-HM3621AC	Cased	3.0	900/1,400	30,000-36,000	5.70	21"	3/8", 3/4"	60 lbs	
131741	RCFL-HM3821CC	Cased	3.0	1,200/1,800	30,000-36,000	8.55	21"	3/8", 7/8"	83 lbs	
131742	RCFL-HM3824CC	Cased	3.0	1,200/1,800	30,000-36,000	8.55	24-1/2"	3/8", 7/8"	99 lbs	
090466	RCFL-HM4821AC	Cased	3.5-4.0	1,200/1,800	42,000-48,000	8.55	21"	3/8", 7/8"	83 lbs	
090467	RCFL-HM4824AC	Cased	4.0	1,200/1,800	42,000-48,000	8.55	24-1/2"	3/8", 7/8"	99 lbs	
090468	RCFL-HM6024AC	Cased	5.0	1,600/1,900	60,000	9.98	24-1/2"	3/8", 7/8"	118 lbs	

* 14" 2-Ton is part of the "N-Coil" design series, even though the coil shape resembles an "A" coil design

Cooling - Equipment & Rooftop Units



Coils

R-410A Cased/Uncased Coils - Gas & Oil Furnaces - RCF

- Rheem® Indoor Replacement Coils are designed for use with Rheem outdoor units and are available for vertical upflow or downflow, and horizontal left or horizontal right airflow. When matched with Rheem outdoor units, the coils provide a nominal capacity range from 18,000 BTU/HR [5.24 kW] to 60,000 BTU/HR [17.6 kW].
- Constructed of aluminum fins bonded to internally grooved aluminum tubing.
- Coils are tested at the factory with an extensive refrigerant leak check.
- Coils have copper sweat refrigerant connections.
- Feature two sets of 3/4" [14.1 mm] N.P.T. Condensate drain connections for ease of connection.
- Chatleff metering device connections, at inlet and outlet of TXV or EEV and equalizer connections (TXV only).
- Approved for system application with variety of Rheem outdoor units.
- Condensate drain pan is constructed of high grade, heat resistant, corrosion free thermal-set material.
- Compatible with Germicidal Light System (UV resistant).
- Bi-Directional airflow eliminates the need to switch any internal components from horizontal left to right.
- Unique drain pan design maximizes application flexibility and condensate removal.
- N-Coil design maximizes performance and minimizes height required at installation.



Standard Efficiency

Part #	Mfg #	Type	Tons	Air-Flow CFM Range	Nominal Capacity BTUH	Face Area Sq Ft	Coil Size	Line Sets Liq, Suction	Ship Wt	Price
171742	RCF2414STAMCA	Cased	2.0	600/900	24,000	4.56	14"	3/8", 3/4"	47 lbs	
171743	RCF2417STAMCA	Cased	2.0	600/900	24,000	4.56	17-1/2"	3/8", 3/4"	48 lbs	
171747	RCF3617STAMCA	Cased	3.0	700/1300	36,000	5.70	17-1/2"	3/8", 3/4"	54 lbs	
171748	RCF3621STAMCA	Cased	3.0	700/1300	36,000	5.70	21"	3/8", 3/4"	60 lbs	
171750	RCF4821STAMCA	Cased	4.0	600/1900	48,000	8.55	21"	3/8", 3/4"	78 lbs	
171752	RCF4824STAMCA	Cased	4.0	1100/1800	48,000	8.55	24"	3/8", 3/4"	93 lbs	
171753	RCF6021STAMCA	Cased	5.0	1400/1600	60,000	7.60	21"	3/8", 7/8"	86 lbs	
171754	RCF6024STAMCA	Cased	5.0	1400/1800	60,000	9.98	24.5"	3/8", 3/4"	108 lbs	
177565	RCF6021SEAMCA	Cased	5.0	1400/1600	60,000	7.60	21"	3/8", 3/4"	108 lbs	

Mid. Efficiency

Part #	Mfg #	Type	Tons	Air-Flow CFM Range	Nominal Capacity BTUH	Face Area Sq Ft	Coil Size	Line Sets Liq, Suction	Ship Wt	Price
171745	RCF2417MTAMCA	Cased	2.0	600/900	24,000	4.56	17"	3/8", 3/4"	54 lbs	
171746	RCF2421MTAMCA	Cased	2.0	600/900	24,000	5.70	21"	3/8", 3/4"	60 lbs	
172854	RCF3621MTAMCA	Cased	3.0	600/1900	36,000	8.55	21"	3/8", 3/4"	78 lbs	
171749	RCF3624MTAMCA	Cased	3.0	700/1300	36,000	8.55	24"	3/8", 3/4"	93 lbs	
171751	RCF4821MTAMCA	Cased	4.0	1100/1800	48,000	7.60	21"	3/8", 7/8"	86 lbs	
177563	RCF2421MEAMCA	Cased	2.0	600/900	24,000	5.70	21"	3/8", 3/4"	60 lbs	
177564	RCF3621MEAMCA	Cased	3.0	600/1900	36,000	8.55	21"	3/8", 3/4"	78 lbs	
177566	RCF6024MEAMCA	Cased	5.0	1400/1800	60,000	9.98	24.5"	3/8", 3/4"	108 lbs	



Coils

High Efficiency

Part #	Mfg #	Type	Tons	Air-Flow CFM Range	Nominal Capacity BTUH	Face Area Sq Ft	Coil Size	Line Sets Liq, Suction	Ship Wt	Price
171755	RCF2417HTAMCA	Cased	2.0	600/900	24,000	4.56	17-1/2"	3/8", 3/4"	54 lbs	
171756	RCF2421HTAMCA	Cased	2.0	600/900	24,000	5.70	21"	3/8", 3/4"	60 lbs	
171757	RCF3621HTAMCA	Cased	3.0	700/1300	36,000	7.60	21"	3/8", 7/8"	86 lbs	
171758	RCF3624HTAMCA	Cased	3.0	700/1300	36,000	9.98	24"	3/8", 3/4"	108 lbs	
171759	RCF4824HTAMCA	Cased	4.0	1100/1800	48,000	9.98	24"	3/8", 3/4"	108 lbs	
171760	RCF6024HTAMCA	Cased	5.0	1400/1800	60,000	9.98	24"	3/8", 3/4"	108 lbs	

Cooling - Equipment & Rooftop
Units



Coils

EEV Models

2 Ton

Part #	Mfg #	Efficiency	Tons	CFM	BTUH	H x L x W	Price
185065	RCF2417SEAMCA	Standard	2 Ton	600/900	24,000	20" x 21-11/16" x 17-1/2"	

3 Ton

Part #	Mfg #	Efficiency	Tons	CFM	BTUH	H x L x W	Price
185066	RCF3617SEAMCA	Standard	3 Ton	700/1300	36,000	20" x 21-11/16" x 17-1/2"	
229040	RCF3621SEAMCA	Standard	3 Ton	700/1300	36,000	20" x 21-11/16" x 21"	

Coil Accessories

RXBM - Horizontal Drain Pan

Part #	Mfg #	Description	Price
009027	RXBM-AA06	4-1/2"H x 35"W x 22"D	
009020	RXBA-AC	Coupler/Adapter To Match Coil to Furnace One Size Smaller	

Cooling - Equipment & Rooftop Units

Coils

CA Series DX-Treme Uncased Upflow/Downflow Coils

- Rifled copper tubing, enhanced aluminum fins
- Immersion-tested at 500 psi, then nitrogen-pressurized and sealed
- Left or right-hand refrigerant and plumbing connections
- Liquid line - 3/8" ODS, suction line - 7/8" ODS
- Externally mounted flowrater body with Schrader valve for hiss-testing
- Heavy duty polypropylene drain pans on most models
- Drain connection: 177L pans have single LH 3/4" MPT
- Upflow without field modification
- Downflow plate kit included
- ARI Certifiable with all brands of A/C and heat pump systems
- ETL Listed for use with R-22 and R-410A when proper metering device is used
- 10-Year limited warranty

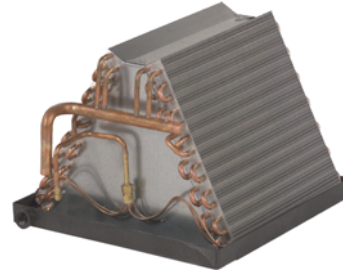

Part #	Mfg #	Tons	Pan Widths	Dimensions Pan Depth	Bare Slab Height	Refrig	Price
104089	CA24A2F-160R	2.0	16"	19-3/8"	12"	R-410A/R-22	
108690	CA24B3F-130R	2.0	13"	19-3/8"	14"	R-410A/R-22	
108692	CA24B3F-160R	2.0	16"	19-3/8"	14"	R-410A/R-22	
104090	CA30A2F-160R	2.5	16"	19-3/8"	14"	R-410A/R-22	
108693	CA30B3F-160R	2.5	16"	19-3/8"	16"	R-410A/R-22	
104091	CA36A2F-160R	3.0	16"	19-3/8"	16"	R-410A/R-22	
108694	CA36B3F-160R	3.0	16"	19-3/8"	18"	R-410A/R-22	
108695	CA36B3F-195R	3.0	19-1/2"	19-3/8"	18"	R-410A/R-22	

CC Series DX-Treme Cased Upflow/Downflow Coils

- Rifled copper tubing, enhanced aluminum fins
- Immersion-tested at 500 psi, then nitrogen-pressurized and sealed
- Left or right-hand refrigerant and plumbing connections, L: Left-hand & R: Right-hand
- Liquid line - 3/8" ODS, suction line - 7/8" ODS
- Externally mounted Flowrater body with Schrader valve for hiss-testing
- Heavy-duty polypropylene drain pans on most models
- Embossed galvanized cabinets standard - cabinets feature furnace connectors
- Split access doors in front for easy service
- Fully insulated cabinets with faced insulation
- ARI Certifiable with all brands of A/C and heat pump systems
- ETL Listed for use with R-22 and R-410A when proper metering device is used
- 10-Year limited warranty
- Option codes:
 - (023) - Flanged top duct opening
 - (056) - Painted cabinet and flange top opening

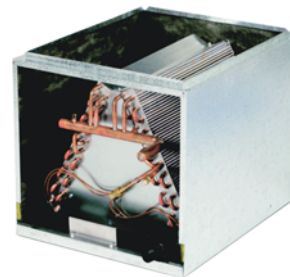

Part #	Mfg #	Tons	Min Width	Dimensions Max Width	Depth	Height	Metering Device	Price
110828	CC24B34-140L	2	14"	23"	21-1/2"	16"	NB TXV R-410	
110829	CC24B34-175L	2	14"	23"	21-1/2"	16"	NB TXV R-410	
110830	CC24D44-175L	2	14"	23"	21-1/2"	20"	NB TXV R-410	
133511	CC30B44-175L1	2.5	14"	23"	21-1/2"	20"	NB TXV R-410	
126429	CC30C44-175L	2.5	14"	23"	21-1/2"	20"	NB TXV R-410	

Coils

CC Series DX-Treme Cased Upflow/Downflow Coils (Continued)

Part #	Mfg #	Tons	Min Width	Dimensions Max Width	Depth	Height	Metering Device	Price
110831	CC30D44-175L	2.5	14"	23"	21-1/2"	24"	NB TXV R-410	
099999	CC30D4X-210R	2.5	14"	23"	21-1/2"	24"	NB TXV R-22	
110833	CC36B34-175L	3	14" or 17"	23"	21-1/2"	20"	NB TXV R-410	
110834	CC36B34-210L	3	14" or 17"	23"	21-1/2"	20"	NB TXV R-410	
115251	CC36C44-175L	3	14" or 17"	23"	21-1/2"	24"	NB TXV R-410	
110835	CC36D44-175L	3	14" or 17"	23"	21-1/2"	24"	NB TXV R-410	
110836	CC36D44-210L	3	14" or 17"	23"	21-1/2"	24"	NB TXV R-410	
110837	CC48B34-210L	4	17"	26-1/2"	21-1/2"	24"	NB TXV R-410	
110838	CC48D44-210L	4	17"	26-1/2"	21-1/2"	28"	NB TXV R-410	
110839	CC48D44-245L	4	17"	26-1/2"	21-1/2"	28"	NB TXV R-410	
110840	CC60B34-210L	5	20-1/2"	26-1/2"	21-1/2"	28"	NB TXV R-410	
110841	CC60B34-245L	5	20-1/2"	26-1/2"	21-1/2"	28"	NB TXV R-410	
125034	CC60E-44-245L-023*	5	24-1/2"	26-1/2"	21-1/2"	28"	NB TXV R-410	

CE Series DX-Treme Cased Multi-Position A-Coil

- Rifled copper tubing, enhanced aluminum fins
- Immersion-tested at 500 psi, then nitrogen-pressurized and sealed
- Left- or right-hand refrigerant and plumbing connections
- Liquid line - 3/8" ODS, suction line - 7/8" ODS
- Externally mounted Flowrater body with Schrader valve for hiss-testing
- Heavy duty polypropylene upflow drains pans on most models, powder coated galvanized steel horizontal drain pans standard on all
- Embossed galvanized cabinets standard
- Cabinets feature furnace connectors (patent pending)
- Upflow, horizontal right, or horizontal left without field modification
Downflow applications require plate kit, included
- Split access doors in front for easy service
- Fully insulated cabinets with faced insulation
- ARI Certifiable with all brands of A/C and heat pump systems
- ETL Listed for use with R-22 and R-410A when proper metering device is used
- 10-Year limited warranty



Part #	Mfg #	Tons	Min Width	Dimensions Max Width	Depth	Height	Metering Device	Price
112852	CE24D44-175L	2	14"	23"	21-1/2"	23"	NB TXV R-410	
112860	CE36D44-210L	3	14" or 17"	23"	21-1/2"	27"	NB TXV R-410	
112859	CE36D44175L0	3	14" or 17"	23"	21-1/2"	27"	NB TXV R-410	
112862	CE48D44-210L	4	17"	26-1/2"	21-1/2"	30"	NB TXV R-410	
112865	CE48D44-245L	4	17"	26-1/2"	21-1/2"	30"	NB TXV R-410	
112866	CE60B34-210L	5	20-1/2"	26-1/2"	21-1/2"	30"	NB TXV R-410	
112867	CE60B34-245L	5	20-1/2"	26-1/2"	21-1/2"	30"	NB TXV R-410	



Coils

Thermostatic Expansion Valves (TXV)

Part #	Mfg #	Refrigerant	Tons	Bleed Port	For:	Price
095918	4190X2-3	R-22	1.5 to 3.5 Ton	No	Kit for B Coils & F Air Handlers	
106976	4195X2-5	R-22	4, 5 & 6 Ton	No	Kit for B Coils & F Air Handlers	
094022	4200X5-3	R-22	1.5 to 3.5 Ton	No	Kit for B Coils & F Air Handlers	
094023	4202X5-5	R-22	4, 5 & 6 Ton	No	Kit for B Coils & F Air Handlers	

R-22 Coils

Part #	Mfg #	Description	Price
147402	22A2F-130R-003	2.0 Ton R-22 Coil	
147403	22A2F-160R-003	2.0 Ton R-22 Coil	
147404	22A3F-160R-003	3.0 Ton R-22 Coil	
147405	22A3F-195R-003	3.0 Ton R-22 Coil	
147406	22A4F-195R-003	4.0 Ton R-22 Coil	
147407	22A5F-230R-003	5.0 Ton R-22 Coil	

Pistons

Part #	Mfg #	Description	Price
125462	3960	.089 Orifice R-410A 5.0 Ton Piston	
125459	3987	.068 Orifice R-22 2.5 Ton Piston	
179307	3991	.084 Orifice R-22 5.0 Ton Piston	
179306	3998	.092 Orifice R-22 5.0 Ton Piston	
125457	3999	.055 Orifice R-22 1.5 Ton Piston	
125458	4000	.059 Orifice R-22 2.0 Ton Piston	
125460	4001	.074 Orifice R-22 3.0 Ton Piston	
125456	4006	.049 Orifice R-410A 1.5 Ton Piston	

Cooling - Equipment & Rooftop
Units

Coils

C7 Residential Indoor Coils



Piston Metering R-410A TXV - "A" Vertical Cased Coil - C7BAM Series

Part #	Mfg #	Order #	Nominal Capacity MBTUH	Refrigerant Sizes Liquid, Suction	Nominal Airflow	Dimensions H x W x D	Price
146441	C7BAM-01824C-A	921515	1.5 - 2.0 Ton	3/8", 3/4"	600/700	20-3/4" x 14-1/2" x 20-3/4"	
146443	C7BAM-01824C-B	921519	1.5 - 2.0 Ton	3/8", 3/4"	550/750	20-3/4" x 17-1/2" x 20-3/4"	
146445	C7BAM-03036C-B	921521	2.5 - 3.0 Ton	3/8", 3/4"	1,000/1,200	20-3/4" x 17-1/2" x 20-3/4"	
146447	C7BAM-03642C-B	921523	3.0 - 3.5 Ton	3/8", 7/8"	1,300/1,300	26-3/4" x 17-1/2" x 20-3/4"	
146448	C7BAM-03648C-C	921525	3.0 - 4.0 Ton	3/8", 7/8"	1,250/1,400	26-3/4" x 21" x 20-3/4"	
146449	C7BAM-042C-D	921529	3.5 Ton	3/8", 7/8"	1,300	30-1/4" x 24-1/2" x 20-3/4"	
146452	C7BAM-048C-C	921838	4.0 Ton	3/8", 7/8"	1,300/1,700	30-1/4" x 21" x 20-3/4"	
146453	C7BAM-048C-D	921841	4.0 Ton	3/8", 7/8"	1,300/1,700	30-1/4" x 24-1/2" x 20-3/4"	

R-410A TXV Kits

Part #	Mfg #	Description	Price
146841	920668A	2.0 Ton R-410A TXV Kit	
146842	920669A	2.5 Ton R-410A TXV Kit	
146843	920670A	3.0 Ton R-410A TXV Kit	
146844	920671A	3.5 Ton R-410A TXV Kit	
146845	920672A	4.0 Ton R-410A TXV Kit	
146846	920673A	5.0 Ton R-410A TXV Kit	

C7 Flex Tube Kit

Part #	Mfg #	Description	Price
150341	921824	A18	
150342	921825	B18	
150343	921826	B24	
150344	921827	C18	
150345	921828	C24	
150346	921829	C28	
150347	921830	D24	
150348	921831	D28	

Coils

C6 Residential Indoor Coils



R-410A TXV - "A" Vertical Cased Coil

Part #	Mfg #	Order #	Nominal Capacity MBTUH	Refrigerant Sizes Liquid, Suction	Nominal Airflow	Dimensions H x W x D	Price
125092	C6BAX26CB	920341	26 (2.0 Ton)	3/8", 3/4"	1,200 cfm	26-3/4" x 17-1/2" x 16-1/8"	
118865	C6BAX42CB	920063	42 (3.5 Ton)	3/8", 7/8"	1,400 cfm	26-3/4" x 17-1/2" x 20-3/4"	
118868	C6BAX48CD	920090	48 (4.0 Ton)	3/8", 7/8"	1,600 cfm	30-1/4" x 24-1/2" x 20-3/4"	
118869	C6BAX60CC	920099	60 (5.0 Ton)	3/8", 7/8"	2,000 cfm	30-1/4" x 21" x 20-3/4"	
118871	C6BAX60CD	920108	60 (5.0 Ton)	3/8", 7/8"	2,000 cfm	30-1/4" x 24-1/2" x 20-3/4"	

R-410A iQ Drive - Horizontal Multi-Poise Cased Coil

Part #	Mfg #	Order #	Nominal Capacity MBTUH	Refrigerant Sizes Liquid, Suction	Nominal Airflow	Dimensions H x W x D	Price
125451	C6BHI24CB	920781	24 (2.0 Ton)	3/8", 3/4"	800 cfm	26-3/4" x 17-1/2" x 20-3/4"	
125452	C6BHI36CB	920782	36 (3.0 Ton)	3/8", 3/4"	1,200 cfm	26" x 17-1/2" x 20-3/4"	
125453	C6BHI36CC	920783	36 (3.0 Ton)	3/8", 3/4"	1,200 cfm	26-3/4" x 21" x 20-3/4"	
125454	C6BHI48CC	920784	48 (4.0 Ton)	3/8", 7/8"	1,600 cfm	30-1/4" x 21" x 20-3/4"	
125455	C6BHI48CD	920785	48 (4.0 Ton)	3/8", 7/8"	1,200 cfm	30-1/4" x 21" x 20-3/4"	

R-410A TXV - Horizontal Multi-Poise Cased Coil

Part #	Mfg #	Order #	Nominal Capacity MBTUH	Refrigerant Sizes Liquid, Suction	Nominal Airflow	Dimensions H x W x D	Price
150738	C6BHX36CC	920188	36 (3.0 Ton)	3/8", 3/4"	1,200 cfm	26-3/4" x 21" x 20-3/4"	
150739	C6BHX48CC	920083	48 (4.0 Ton)	3/8", 7/8"	1,600 cfm	30-1/4" x 21" x 20-3/4"	

Cooling - Equipment & Rooftop Units



Condensing Units

Air Conditioners



- Scroll compressor
- Composite base pan
- Powder coat paint
- External haugue ports
- Single row coil
- Top can be removed without disconnecting motor
- Quick-Release Louver panel design

Warranties

10-Yr Parts Warranty

RA16 Single Stage Condensing Unit

Part #	Mfg #	Tons	Liq Conn.	Suction Conn.	CFM	RPM	H x L x W	Price
171657	RA1618AJ1NA	1.5	3/8"	3/4"	2404	1095	27" x 29-3/4" x 29-3/4"	
171658	RA1624AJ1NA	2.0	3/8"	3/4"	2851	851	27" x 33-3/4" x 33-3/4"	
171659	RA1630AJ1NA	2.5	3/8"	3/4"	3914	840	27" x 35-3/4" x 35-3/4"	
171660	RA1636AJ1NA	3.0	3/8"	3/4"	4340	819	31" x 35-3/4" x 35-3/4"	
171661	RA1642AJ1NA	3.5	3/8"	7/8"	4450	829	39" x 35-3/4" x 35-3/4"	
171662	RA1648AJ1NA	4.0	3/8"	7/8"	4658	828	45" x 35-3/4" x 35-3/4"	
173277	RA1660AJ1NA	5.0	3/8"	7/8"	1775	795	51" x 35-3/4" x 35-3/4"	

RA14 Single Stage Condensing Unit

Part #	Mfg #	Tons	Liq Conn.	Suction Conn.	CFM	RPM	H x L x W	Price
171646	RA1418AJ1NA	1.5	3/8"	3/4"	2225	1075	25" x 29-3/4" x 29-3/4"	
171647	RA1424AJ1NA	2.0	3/8"	3/4"	2505	1070	25" x 29-3/4" x 29-3/4"	
171648	RA1430AJ1NA	2.5	3/8"	3/4"	2605	1075	27" x 29-3/4" x 29-3/4"	
171649	RA1436AJ1NA	3.0	3/8"	3/4"	3105	805	27" x 33-3/4" x 33-3/4"	
171650	RA1442AJ1NA	3.5	3/8"	7/8"	4265	820	27" x 35-3/4" x 35-3/4"	
171651	RA1448AJ1NA	4.0	3/8"	7/8"	4265	820	31" x 35-3/4" x 35-3/4"	
171652	RA1460AJ1NA	5.0	3/8"	7/8"	4140	850	35" x 35-3/4" x 35-3/4"	

RA13 Single Stage Condensing Unit

Part #	Mfg #	Tons	Liq Conn.	Suction Conn.	CFM	RPM	H x L x W	Price
171633	RA1318AJ1NA	1.5	3/8"	3/4"	2040	1075	27" x 29-3/4" x 29-3/4"	
171634	RA1324AJ1NA	2.0	3/8"	3/4"	2325	1075	25" x 29-3/4" x 29-3/4"	
171635	RA1330AJ1NA	2.5	3/8"	3/4"	2795	1075	25" x 29-3/4" x 29-3/4"	
171636	RA1336AJ1NA	3.0	3/8"	3/4"	2900	1075	27" x 29-3/4" x 29-3/4"	
171637	RA1342AJ1NA	3.5	3/8"	7/8"	2465	1075	31" x 29-3/4" x 29-3/4"	
171638	RA1348AJ1NA	4.0	3/8"	7/8"	4145	850	27" x 33-3/4" x 33-3/4"	
171639	RA1360AJ1NA	5.0	3/8"	7/8"	3870	820	31" x 35-3/4" x 35-3/4"	



Condensing Units

RA16 Single Stage Condensing Unit High/Low Pressure

Part #	Mfg #	Tons	Liq Conn.	Suction Conn.	CFM	RPM	H x L x W	Price
171663	RA1636AC1NB	3.0	3/4"	3/8"	4340	819	31" x 35-3/4" x 35-3/4"	
171664	RA1642AC1NB	3.5	3/4"	7/8"	4450	829	39" x 35-3/4" x 35-3/4"	
171665	RA1648AC1NB	4.0	3/4"	7/8"	4658	828	45" x 35-3/4" x 35-3/4"	
171666	RA1660AC1NB	5.0	3/8"	7/8"	4776	795	51" x 35-3/4" x 35-3/4"	

RA14 Single Stage Condensing Unit High/Low Pressure

Part #	Mfg #	Tons	Liq Conn.	Suction Conn.	CFM	RPM	H x L x W	Price
171653	RA1436AC1NB	3.0	3/8"	3/4"	3105	850	27" x 33-3/4" x 33-3/4"	
171654	RA1442AC1NB	3.5	3/8"	7/8"	4265	820	27" x 35-3/4" x 35-3/4"	
171655	RA1448AC1NB	4.0	3/8"	7/8"	4265	820	1" x 35-3/4" x 35-3/4"	
171656	RA1460AC1NB	5.0	3/8"	7/8"	4140	850	35" x 35-3/4" x 35-3/4"	

RA13 Single Stage Condensing Unit High/Low Pressure

Part #	Mfg #	Tons	Liq Conn.	Suction Conn.	CFM	RPM	H x L x W	Price
171641	RA1336AC1NB	3.0	3/8"	3/4"	2900	1075	27" x 29-3/4" x 29-3/4"	
171643	RA1342AC1NB	3.5	3/8"	7/8"	2465	1075	25" x 29-3/4" x 29-3/4"	
171644	RA1348AC1NB	4.0	3/8"	7/8"	4145	850	27" x 33-3/4" x 33-3/4"	
171645	RA1360AC1NB	5.0	3/8"	7/8"	3870	820	31" x 35-3/4" x 35-3/4"	
185055	RA1360AD1NB	5.00	3/8"	7/8"	3870	820	31" x 35-3/4" x 35-3/4"	

Cooling - Equipment & Rooftop Units



Condensing Units

Achiever Plus™ Series



- Efficiencies up to 17 SEER/13 EER
- EcoNet™ enabled
- Two-Stage
- Scroll compressor
- Optimized fan orifice
- Rust resistant screws
- PlusOne™ Expanded Valve Space
- PlusOne™ Triple Service Access
- New composite base pan
- Two Stage Copeland Scroll™ UltraTech™ Compressor

Warranties

Conditional Unit Replacement - 10 Years (Registration Required)

Parts - 10 Years

UA17 Two Stage Condensing Unit

Part #	Mfg #	Tons	Liq Conn.	Suction Conn.	CFM	RPM	H x L x W	Price
177559	UA1724AJ2CB	2.0	3/8"	3/4"	3326	850	35" x 33-3/4" x 33-3/4"	
177560	UA1736AJ2CB	3.0	3/8"	3/4"	3540	820	39" x 33-3/4" x 33-3/4"	
177561	UA1748AJ2CB	4.0	3/8"	7/8"	4521	646	51" x 35-3/4" x 35-3/4"	
177562	UA1760AJ2CB	5.0	3/8"	7/8"	5133	825	51" x 35-3/4" x 35-3/4"	

Air Conditioners



- Scroll compressor
- Composite base pan
- Powder coat paint
- External gauge ports
- Single Row Coil
- Top can be removed without disconnecting motor
- Quick Release louver panel design

Warranties

10-Yr Parts Warranty

UA20 Variable Speed Condensing Unit

Part #	Mfg #	Tons	Liq Conn.	Suction Conn.	CFM	RPM	H x L x W	Price
188639	UA2024AJVCB	2.0	3/8"	3/4"	3330	772	39" x 33-3/4" x 33-3/4"	
188640	UA2036AJVCB	3.0	3/8"	3/4"	4315	825	39" x 33-3/4" x 33-3/4"	
188641	UA2048AJVCB	4.0	3/8"	7/8"	6240	935	51" x 35-3/4" x 35-3/4"	
188999	UA2060AJVCB	5.0	3/8"	7/8"	6175	900	51" x 35-3/4" x 35-3/4"	

Condensing Units

Residential Air Conditioners

- Composite Base Pan
- Permanently Lubricated Motor
- Durable, Attractive Cabinet
- Removable Top Grille Assembly
- High Pressure Switch
- Liquid Line Filter Drier
- One Piece Top/Orifice
- Easy Compressor and Control Access
- Complete Metal Wrapper
- Micro-Channel Coils



JS4BD R-410A 13 Seer Condensor A/C

Part #	Mfg #	Tons	Liq Conn	Suction Conn	Dimensions (H x W)	Price
118705	JS4BD018KB	1.5	3/8"	3/4" (0-24 ft)	23 1/2" x 22 3/4"	
118706	JS4BD024KB	2	3/8"	3/4" (0-24 ft)	23 1/2" x 22 3/4"	
118707	JS4BD030KB	2.5	3/8"	3/4" (0-24 ft)	27 1/2" x 22 3/4"	
118708	JS4BD036KB	3	3/8"	3/4" (0-24 ft)	27 1/2" x 22 3/4"	
118710	JS4BD042KB	3.5	3/8"	7/8" (0-24 ft)	27 1/2" x 30 3/4"	
118711	JS4BD048KB	4	3/8"	7/8" (0-24 ft)	27 1/2" x 30 3/4"	
118712	JS4BD060KB	5	3/8"	7/8" (0-24 ft)	31 1/2" x 30 3/4"	

JS4BE R-410A 14 Seer Condensor A/C

Part #	Mfg #	Tons	Liq Conn	Suction Conn	Dimensions (H x W)	Price
118698	JS4BE018KA	1.5	3/8"	3/4" (0-24 ft)	27" x 22 3/4"	
118699	JS4BE024KA	2	3/8"	3/4" (0-24 ft)	31" x 22 3/4"	
118700	JS4BE030KA	2.5	3/8"	3/4" (0-24 ft)	27" x 30 3/4"	
118701	JS4BE036KA	3	3/8"	3/4" (0-24 ft)	35" x 30 3/4"	
118702	JS4BE042KA	3.5	3/8"	7/8" (0-24 ft)	39" x 30 3/4"	
118703	JS4BE048KA	4	3/8"	7/8" (0-24 ft)	39" x 30 3/4"	
118704	JS4BE060KA	5	3/8"	7/8" (0-24 ft)	43" x 30 3/4"	

Cooling - Equipment & Rooftop Units

Condensing Units - Single Phase

JS4B Series Residential Air Conditioners

- ComfortAlert™ module detects system & electrical problem conditions
- Copeland scroll UltraTech™ compressor
- Galvanized steel with polyester urethane finish cabinet
- Composite base pan
- Copper tube/aluminum fin coils
- Permanently lubricated motors
- Full port service valves
- Swept-wing fan blade & louvered condenser guard
- Removable top grille assembly
- One piece top/orifice
- 2-1/2" Pedestal base
- Easy compressor and control access
- 208/230-60-1 Electrical
- 10-Year all-parts warranty (product registration required)



14 SEER - R-410A - 208/230-1-60 - JS4BE Series A/C

- Copper tube/aluminum fin coils
- 1-Year quality pledge on compressor unit (product registration required)



Part #	Mfg #	Order #	Nominal Capacity MBTUH	Sizes Liquid, Suction	Refrigerant Dimensions H x W x D	SEER	Approx Ship Wt	Price
118698	JS4BE-018K	919591J	18 (1.5 Ton)	3/8", 3/4"	31" x 30-3/4" x 30-3/4"	14.0	171 lbs	
118699	JS4BE-024K	919592J	24 (2.0 Ton)	3/8", 3/4"	31" x 30-3/4" x 30-3/4"	14.0	175 lbs	
118700	JS4BE-030K	919593J	30 (2.5 Ton)	3/8", 3/4"	35" x 30-3/4" x 30-3/4"	14.0	180 lbs	
118701	JS4BE-036K	919594J	36 (3.0 Ton)	3/8", 3/4"	39" x 30-3/4" x 30-3/4"	14.0	185 lbs	
118702	JS4BE-042K	919595J	42 (3.5 Ton)	3/8", 7/8"	43" x 30-3/4" x 30-3/4"	14.0	190 lbs	
118703	JS4BE-048K	919596J	48 (4.0 Ton)	3/8", 7/8"	43" x 30-3/4" x 30-3/4"	14.0	232 lbs	
118704	JS4BE-060K	919597J	60 (5.0 Ton)	3/8", 7/8"	43" x 30-3/4" x 30-3/4"	14.0	235 lbs	

13 SEER - High Efficiency Single-Phase - R-410A - JS4BD Series

Part #	Mfg #	Order #	Nominal Capacity MBTUH	Sizes Liquid, Suction	Refrigerant Dimensions H x W x D	SEER	Approx Ship Wt	Price
118705	JS4BD-018KA	919584J	18 (1.5 Ton)	3/8", 3/4"	23" x 22-3/4" x 22-3/4"	13-14	114 lbs	
118706	JS4BD-024KA	919585J	24 (2.0 Ton)	3/8", 3/4"	23" x 22-3/4" x 22-3/4"	13-14	130 lbs	
118707	JS4BD-030KA	919585J	30 (2.5 Ton)	3/8", 3/4"	27" x 22-3/4" x 22-3/4"	13-14	144 lbs	
118708	JS4BD-036KA/B	919587J	36 (3.0 Ton)	3/8", 3/4"	27" x 22-3/4" x 22-3/4"	13-14	146 lbs	
118710	JS4BD-042KA	919588J	42 (3.5 Ton)	3/8", 7/8"	31" x 30-3/4" x 30-3/4"	13-14	196 lbs	
118711	JS4BD-048KA	919589J	48 (4.0 Ton)	3/8", 7/8"	31" x 30-3/4" x 30-3/4"	13-14	196 lbs	
118712	JS4BD-060KA	919590J	60 (5.0 Ton)	3/8", 7/8"	43" x 30-3/4" x 30-3/4"	13-14	228 lbs	

Condensing Units - Single Phase

JS5B Series Residential Air Conditioners

- Galvanized steel with polyester urethane finish cabinet
- Copper tube/aluminum fin coils
- Permanently lubricated motors
- Full service valves
- Complete metal wrapper
- Removable top grille assembly
- One-piece top/orifice
- 2-1/2" Pedestal base
- Easy compressor and control access
- 208/230-60-1 Electrical
- 10-Year all-parts warranty (product registration required)



13 SEER - High Efficiency - JS5BD Series

Part #	Mfg #	Order #	Nominal Capacity MBTUH	Sizes Liquid, Suction	Refrigerant Dimensions H x W x D	SEER	Approx Ship Wt	Price
119544	JS5BD-018KA	919370J	18 (1.5 Ton)	3/8", 3/4"	22-1/2" x 22-1/2" x 22-1/2"	13-14	107 lbs	
119545	JS5BD-024KA	919371J	24 (2.0 Ton)	3/8", 3/4"	26-1/2" x 22-1/2" x 22-1/2"	13-14	117 lbs	
119546	JS5BD-030KA	919372J	30 (2.5 Ton)	3/8", 3/4"	34-1/2" x 22-1/2" x 22-1/2"	13-14	129 lbs	
119547	JS5BD-036KA	919373J	36 (3.0 Ton)	3/8", 3/4"	34-1/2" x 22-1/2" x 22-1/2"	13-14	129 lbs	
119548	JS5BD-042KA	919374J	42 (3.5 Ton)	3/8", 7/8"	30-1/2" x 30-1/2" x 30-1/2"	13-14	162 lbs	
119549	JS5BD-048KA	919375J	48 (4.0 Ton)	3/8", 7/8"	30-1/2" x 30-1/2" x 30-1/2"	13-14	183 lbs	
119550	JS5BD-060KA	919376J	60 (5.0 Ton)	3/8", 7/8"	42-1/2" x 30-1/2" x 30-1/2"	13-14	238 lbs	

Cooling - Equipment & Rooftop Units



Heat Pumps

Achiever Series Heat Pumps



- Scroll Compressor
- High & Low Pressure Switches
- Composite Base Pan
- Powder Coat Paint
- External Gauge Ports
- Single Row Coil
- Top Can be Removed without Disconnecting Motor
- Quick Release Louver Panel Design

Warranties

10-Yr Parts Warranty

R15 Heat Pump

R-410A

Part #	Mfg #	Tons	BTUH	Liquid Conn	Suction Conn	H x L x W	Price
171675	RP1518AJ1NA	1.5	18,000	3/8"	3/4"	25" x 29-3/4" x 29-3/4"	
171676	RP1524AJ1NA	2.0	24,000	3/8"	3/4"	25" x 29-3/4" x 29-3/4"	
171677	RP1530AJ1NA	2.5	30,000	3/8"	3/4"	31" x 33-3/4" x 33-3/4"	
171678	RP1536AJ1NA	3.0	36,000	3/8"	3/4"	35" x 33-3/4" x 33-3/4"	
171679	RP1542AJ1NA	3.5	42,000	3/8"	7/8"	35" x 33-3/4" x 33-3/4"	
171680	RP1548AJ1NA	4.0	48,000	3/8"	7/8"	39" x 35-3/4" x 35-3/4"	
171681	RP1560AJ1NA	5.0	60,000	3/8"	7/8"	45" x 35-3/4" x 35-3/4"	

RP14 Heat Pump

R-410A

Part #	Mfg #	Tons	BTUH	Liquid Conn	Suction Conn	H x L x W	Price
171668	RP1418AJ1NA	1.5	18,000	3/8"	3/4"	25" x 29-3/4" x 29-3/4"	
171669	RP1424AJ1NA	2.0	24,000	3/8"	3/4"	25" x 29-3/4" x 29-3/4"	
171670	RP1430AJ1NA	2.5	30,000	3/8"	3/4"	25" x 29-3/4" x 29-3/4"	
171671	RP1436AJ1NA	3.0	36,000	3/8"	3/4"	27" x 33-3/4" x 33-3/4"	
171672	RP1442AJ1NA	3.5	42,000	3/8"	7/8"	27" x 33-3/4" x 33-3/4"	
171673	RP1448AJ1NA	4.0	48,000	3/8"	7/8"	35" x 33-3/4" x 33-3/4"	
171674	RP1460AJ1NA	5.0	60,000	3/8"	7/8"	39" x 35-3/4" x 35-3/4"	

Cooling - Equipment & Rooftop Units

Heat Pumps

Achiever Plus Series Heat Pumps

- EcoNet™ Enables
- Variable speed scroll compressor
- High pressure switch
- Low pressure transducer
- Powder coat paint
- Field installed filter drier
- Front seating service valves
- Electronic expansion valve

ACHIEVER
Series



Warranties

10-Yr Parts Warranty

UP17 Variable Speed Heat Pump 3-Stage R-410A

Part #	Mfg #	Tons	BTUH	Liquid Conn	Suction Conn	H x L x W	Price
185061	UP1724AJVCA	2	24,000	3/8"	3/4"	35" x 33-3/4" x 33-3/4"	
185062	UP1736AJVCA	3	36,000	3/8"	3/4"	35" x 33-3/4" x 33-3/4"	
185063	UP1748AJVCA	4	48,000	3/8"	7/8"	39" x 35-3/4" x 35-3/4"	
185064	UP1760AJVCA	5	60,000	3/8"	7/8"	45" x 35-3/4" x 35-3/4"	

Ultra Series Heat Pumps

- Scroll compressor
- High & Low pressure switches
- Composite base pan
- Powder coat paint
- External guage ports
- Single row coil
- Top can be removed without disconnecting motor
- Quick release louver panel design
- R-410A Refrigerant

ULTRA
Series



Warranties

10-Yr Parts Warranty

UP20 Variable Speed Heat Pump R-410A

Part #	Mfg #	Tons	BTUH	Liquid Conn	Suction Conn	H x L x W	Price
189000	UP2024AJVCA	2.0	24,000	3/8"	3/4"	35" x 35-3/4" x 35-3/4"	
222340	UP2036AJVCA	3.0	36,000	3/8"	3/4"	39" x 35-3/4" x 35-3/4"	
189001	UP2048AJVCA	4.0	48,000	3/8"	7/8"	51" x 35-3/4" x 35-3/4"	
222820	UP2060AJVCA	5.0	60,000	3/8"	7/8"	51" x 35-3/4" x 35-3/4"	

Cooling - Equipment & Rooftop Units

Heat Pumps

Heat Pumps

JT4BF Extra High Efficiency Heat Pumps

- Copeland Scroll UltraTech™ Compressor
- Durable, Attractive Cabinet
- Composite Base Pan
- Demand Defrost
- Copper Tube / Aluminum Fin Coils
- Complete Metal Wrapper
- Removable Top Grille Assembly.
- Low Pressure Switch:
- High Pressure Switch
- Liquid Line Filter Drier
- One Piece Top/Orifice
- Common Suction Service Port
- Three Minute Restart Time Delay
- Suction Accumulator
- Hot Gas Muffler
- Easy Compressor and Control Access



Cooling - Equipment & Rooftop
Units

Part #	Mfg #	Tons	Liq Conn	Suction Conn	Dimensions (H x W)	Price
118740	JT4BF024KB	2	3/8"	3/4" (0-24 ft)	43 1/2" x 31"	
118741	JT4BF036KA	3	3/8"	7/8" (0-24 ft)	43 1/2" x 31"	
118742	JT4BF048KA	4	3/8"	7/8" (0-24 ft)	43 1/2" x 31"	
118743	JT4BF060KA	5	3/8"	7/8" (0-24 ft)	43 1/2" x 31"	

Mini-Split Components & Accessories

Single Zone Indoor Air Handler Units

- *Model Nomenclature Prefix*
- **ASU** Wall Mount
- **ABU** Universal Mount
- **ARU** Slim Duct
- **AUU** Cassette Mount
- **AGU** Floor Mount

Part #	Mfg #	Nom Cool BTUH	Nom Heat BTUH	SEER	HSPF	Indoor/Outdoor Combo	Price
172855	ASU18RLB	18,000	24,000	19.0	10.6	12-5/8"H x 39-5/16"W x 9"D	
172858	ASU24RLB	24,000	24,000	18.0	10.6	12-5/8"H x 39-5/16"W x 9"D	
172861	ASU30RLXB	30,700	30,000	16.5	9.0	12-5/8"H x 39-5/16"W x 9"D	
172864	ASU36RLXB	33,000	34,000	15.5	9.0	12-5/8"H x 39-1/2"W x 9"D	
172177	ASU9RLS3	9,000	12,000	33.0	14.00	11-5/8"H x 37"W x 10-5/8"D	
172183	ASU12RLS3	12,000	16,000	33.0	13.8	11-5/8"H x 37"W x 10-5/8"D	
172189	ASU15RLS3	14,500	18,000	33.0	13.3	11-5/8"H x 37"W x 10-5/8"D	
114270	ASU30RLX	36,000	32,000	17.5	8.5	12-5/8"H x 39-1/2"W x 9"D	
110547	ABU18RULX	17,800	21,500	16.0	8.5	25-7/8"H x 39-1/8"W x 7-7/8"D	
127976	ABU24RULX	22,200	24,000	15.0	8.5	25-7/8"H x 39-1/8"W x 7-7/8"D	
132067	ABU36RSLX	34,100	36,500	14.0	8.5	27-5/8"H x 65-1/2"W x 9-1/2"D	
103316	AUU18RCLX	17,800	21,000	16.0	8.5	9-3/4"H x 32-3/4"W x 32-3/4"D	
103314	AUU24RCLX	22,200	24,200	15.0	8.5	9-3/4"H x 32-3/4"W x 32-3/4"D	
111987	AUU36RCLX	34,100	36,000	14.0	8.5	11-5/8"H x 32-3/4"W x 32-3/4"D	
120771	AUU42RCLX	42,700	45,200	15.0	8.5	11-5/8"H x 32-3/4"W x 32-3/4"D	

Single Zone Outdoor Condenser Units

Part #	Mfg #	Nom Cool BTUH	Nom Heat BTUH	SEER	HSPF	Indoor/Outdoor Combo	Price
172856	AOU18RLB	18,000	24,000	19.0	10.6	24-7/16"H x 31-1/8"W x 11-7/16"D	
172859	AOU24RLB	24,000	24,000	18.0	10.6	24-7/16"H x 31-1/8"W x 11-7/16"D	
172862	AOU30RLXB	30,700	30,000	16.5	9.0	32-3/4"H x 35-1/2"W x 15-3/4"D	
172865	AOU36RLXB	33,000	34,000	15.5	9.0	32-3/4"H x 35-1/2"W x 15-3/4"D	
163986	AOU9RLFW1	9,000	12,000	23	11.0	21-1/4"H x 26"W x 11-7/16"D	
163991	AOU12RLFW1	12,000	16,000	22.0	11.0	21-1/4"H x 31-1/8"W x 11-7/16"D	
136262	AOU18RLXFW	18,000	18,000	Up to 19.2	Up to 10	32-3/4"H x 35-3/8"W x 13"D	
224794	AOU24RLXFW 1	24,000	24,000	Up to 18.0	Up to 10	32-3/4"H x 35-3/8"W x 13"D	
172181	AOU9RLS3H	9,000	12,000	33	14.00	24-7/16"H x 31-1/8"W x 11-11/32"D	
172186	AOU12RLS3H	12,000	16,000	33	13.8	24-7/16"H x 31-1/8"W x 11-11/32"D	
172192	AOU15RLS3H	14,500	18,000	33	13.3	24-7/16"H x 31-1/8"W x 11-11/32"D	
172178	AOU9RLS3	9,000	12,000	27.2	12.5	24-13/32"H x 31-3/32"W x 13-27/32"D	
172184	AOU12RLS3	12,000	16,000	25.0	12.0	24-13/32"H x 31-3/32"W x 13-27/32"D	
172190	AOU15RLS3	14,500	18,000	21.5	12.0	24-13/32"H x 31-3/32"W x 13-27/32"D	
103317	AOU18RLX	17,800	21,000	16.0	8.5	32-3/4"H x 35-1/2"W x 13"D	
103315	AOU24RLX	22,200	24,200	15.0	8.5	32-3/4"H x 35-1/2"W x 13"D	
114272	AOU30RLX	36,000	32,000	17.5	8.5	32-3/4"H x 35-1/2"W x 13"D	
111988	AOU36RLX	34,100	36,500	14.0	8.5	32-3/4"H x 35-1/2"W x 13"D	

Cooling - Equipment & Rooftop Units

Mini-Split Components & Accessories

Single Zone Outdoor Condenser Units (Continued)

Part #	Mfg #	Nom Cool BTUH	Nom Heat BTUH	SEER	HSPF	Indoor/Outdoor Combo	Price
120772	AOU42RLX	42,700	45,200	15.0	8.5	50-7/8"H x 35-1/2"W x 13"D	
163994	AOU9RLFF	9,000	12,000	26	12.6	24-7/16"H x 31-1/8"W x 11-7/16"D	
164000	AOU12RLFF	12,000	16,000	22.7	11.6	24-7/16"H x 31-1/8"W x 11-7/16"D	
164005	AOU15RLFF	14,200	18,000	20.3	11.2	24-7/16"H x 31-1/8"W x 11-7/16"D	
163995	AOU9RLFFH	9,000	12,000	26.0	12.6	24-7/16"H x 31-1/8"W x 11-7/16"D	
164001	AOU12RLFFH	12,000	16,000	22.7	11.6	24-7/16"H x 31-1/8"W x 11-7/16"D	
164006	AOU15RLFFH	14,200	18,000	20.3	11.2	24-7/16"H x 31-1/8"W x 11-7/16"D	
154467	AOU9RLFC	9,000	12,000	21.5	12.2	24-13/32"H x 31-3/32"W x 11-11/32"D	
154468	AOU12RLFC	12,000	16,000	20.0	11.5	24-13/32"H x 31-3/32"W x 11-11/32"D	
154469	AOU18RLFC	18,000	21,600	19.7	11.3	24-13/32"H x 31-3/32"W x 13-27/32"D	

Mini Split System Remotes

UTY-RVNUM Wired Remote Controller

- Large backlit LCD display
- Displays room temperature
- Provides full feature access to property managers, building owners, and facility maintenance, as well as providing basic comfort features to tenants, employees, and teachers



Part #	Mfg #	Nom Cool BTU/H	Voltage	SEER	Indoor Fan RPM	Indoor H x W x D	Price
160489	UTY-RVNUM	Wired Remote Controller					

UTY-RNNUM Remote Control for Wall Mounts

- Full function wired remote
- Unique lock function



Part #	Mfg #	Description	Price
133358	UTY-RNNUM	HFI Wired Remote Control for Flex Wall Mounts	

UTY-LNHUM Wireless Remote Control

Part #	Mfg #	Description	Price
133360	UTY-LNHUM	HFI Wireless Remote Control	

UTY-RNBYU Wired Remote Control for Wall-Mounted Units

- Remote control thermo sensor
- Child lock capable

Part #	Mfg #	Description	Price
129542	UTY-RNBYU	Wired Remote Control for Wall-Mounted Units	

Mini-Split Components & Accessories

UTY-RSNUM Simple Wired Remote Control

Part #	Mfg #	Description	Price
133359	UTY-RSNUM	HFI Simple Wired Remote Control	

IR Wireless Module

Part #	Mfg #	Nom Cool BTU/H	Voltage	SEER	Indoor Fan RPM	Indoor H x W x D	Price
177218	FJ-IR-WIFI-1NA	IR Wireless Module for Wall Mounts & Floor Mounts					

External Connect Kit

Part #	Mfg #	Nom Cool BTU/H	Voltage	SEER	Indoor Fan RPM	Indoor H x W x D	Price
157680	UTD-ECS5A	For Indoor Unit					
138785	UTY-XWZX	For Outdoor Unit					

Interface Kit

- Required to connect the ASU9RLS2, ASU12RLS2 and ASU15RLS2 to wired remote UTY-RNNUM, Dry contact wire kit UTY-XWZXZ5, and simple remote control UTY-RSNUM

Part #	Mfg #	Nom Cool BTU/H	Voltage	SEER	Indoor Fan RPM	Indoor H x W x D	Price
154241	UTY-TWBXF1	Interface Kit					

Fujitsu Halcyon Parts & Accessories

Branch Box



UTP-PU03A

Part #	Mfg #	Description	Price
133354	UTP-PU03A	Flex Primary Branch Box	
133355	UTP-PU03B	Flex Secondary Branch Box	
158380	UTP-PX-A	Branch Box Outdoor Enclosure	

Fresh Air Intake Kit

- Mixes room air then passes it through a heat exchanger
- Allows for a 4-inch flex duct connection
- Requires a field supplied duct booster fan capable of 60 CFM at 2"W.C. or 90 CFM 4"W.C.



Part #	Mfg #	Nom Cool BTU/H	Voltage	SEER	Indoor Fan RPM	Indoor H x W x D	Price
151930	UTZ-VXAA	Fresh Air Intake Kit					

Cooling - Equipment & Rooftop Units

Mini-Split Components & Accessories

Condensate Pump

- For ABU36RSLX
- Raises the drain/discharge point of your unit by 11.8"



Part #	Mfg #	Nom Cool BTU/H	Voltage	SEER	Indoor Fan RPM	Indoor H x W x D	Price
141456	UTR-DPB24T	Condensate Pump for ABU36RSLX					

Fitting Kit for 18 and 18 Indoor Combination

Part #	Mfg #	Nom Cool BTU/H	Voltage	SEER	Indoor Fan RPM	Indoor H x W x D	Price
141472	K9FZ1818	Fitting Kit					

Mini-Split Components & Accessories

Fujitsu Halcyon Parts & Accessories



Part #	Mfg #	Description	Price
124548	K9R410A55	Access Fitting (K9R410A)	

Cooling - Equipment & Rooftop Units

Multi Zone Mini-Split Systems

Multi Zone Mini-Splits - Outdoor Units

Multi-Zone Outdoor Units

- Seven year compressor warranty
- Five year parts warranty
- Energy Star Qualified
- Auto Restart/Reset
- Refrigerant R410A
- Quiet Mode
- Sleep Timer



AOU18, 24RLXFZ

AOU36RLXFZ1

AOU45RLXFZ

Part#	Mfg#	Nom Cool	Nom Heat	SEER	HSPF	Dimensions
136565	AOU18RLXFZ	18,000	18,000	19.2	10	27-9/16"H x 35-7/16"W x 13"D
136566	AOU24RLXFZ	24,000	24,000	18.0	10	27-9/16 "H x 35-7/16"W x 13"D
173774	AOU36RLXFZ1	36,000	36,000	18.0	9.4	32-11/16"H x 35-7/16"W x 13"D
189472	AOU45RLXFZ	48,000	48,000	19.7	10.3	39-5/16"H x 38-3/16"W x 14-9/16"D

Multi-Zone XLTH Outdoor Units

- Individual zoning
- Inverter technology
- Inverter control
- Extra low temperature heating
- Base freeze prevention
- Cassette model fits into standard ceiling tile
- Hidden or showcased indoor unit
- Stable and comfortable



Part#	Mfg#	Nom Cool	Nom Heat	SEER	HSPF	Dimensions
173696	AOU18RLXFZH	18,000	22,000	21.5	10.3	32-11/16"H x 35-7/16"W x 13"D
173697	AOU24RLXFZH	22,000	25,000	20.0	10.3	32-11/16"H x 35-7/16"W x 13"D
189473	AOU36RLXFZH	35,200	36,400	20.0	10.3	39-5/16"H x 38-3/16"W x 14-9/16"D

Flex Zone Outdoor Unit

- Individual zoning
- Inverter technology
- Inverter control
- 130% Connectable capacity
- Cassette model fits into standard ceiling tile
- Central remote control (optional accessory part #UTY-DMMUM)
- Hidden or showcased indoor unit
- Stable and comfortable
- Flex provides the ability to connect up to 8-zones



Part#	Mfg#	Nom Cool	Nom Heat	SEER	HSPF	Dimensions
133340	AOU48RLXFZ1	48,000	54,000	17.0	9.8	36"H x 38-1/4"W x 14-5/8"D

Multi Zone Mini-Split Systems

Multi Zone Mini-Splits - Indoor Units

Compact Wall-Mounted Indoor Heat Pump

- Auto Restart/Reset
- Minimum Heat Mode
- Auto Mode
- Dry Mode
- 24-Hour Timer
- Sleep Timer
- Ion Deodorizing Filter
- Apple Catechin Filter



Part#	Mfg#	Nom Cool	Nom Heat	SEER	HSPF	Dimensions	Price
164013	ASU7RLF1	7,000	8,100	17.0	9.8	10-1/2"H x 33-1/16"W x 8"D	
163984	ASU9RLF1	9,000	10,200	17.0	9.8	10-1/2"H x 33-1/16"W x 8"D	
163989	ASU12RLF1	12,000	13,500	17.0	9.8	10-1/2"H x 33-1/16"W x 8"D	

Large Wall-Mounted Indoor Heat Pump

- Auto Restart/Reset
- Minimum Heat Mode
- Auto Mode
- Dry Mode
- 24-Hour Timer
- Sleep Timer
- Ion Deodorizing Filter
- Apple Catechin Filter



Part#	Mfg#	Nom Cool	Nom Heat	SEER	HSPF	Dimensions	Price
133344	ASU18RLF	16,200	20,000	17.0	9.8	12-5/8"H x 39-1/4"W x 9"D	
133345	ASU24RLF	24,000	27,000	17.0	9.8	12-5/8"H x 39-1/4"W x 9"D	

Designer Series Wall-Mounted Indoor Heat Pump

- Auto Restart/Reset
- Minimum Heat Mode
- Auto Mode
- Dry Mode
- 24-Hour Timer
- Sleep Timer
- Ion Deodorizing Filter
- Apple Catechin Filter



Part#	Mfg#	Nom Cool	Nom Heat	SEER	HSPF	Dimensions	Price
229612	ASU15RLF1	14,000	16,300	21.5	-	11-1/8"H x 34-1/4"W x 7-1/4"D	

Cooling - Equipment & Rooftop Units

Multi Zone Mini-Split Systems

Slim Duct Ducted Indoor Heat Pump

- Fresh Air Intake
- Condensate Pump
- Auto Changeover
- Auto Restart/Reset
- Quiet Mode
- Auto Mode
- Weekly Timer
- Dry Mode



Part#	Mfg#	Nom Cool	Nom Heat	SEER	HSPF	Dimensions
167720	ARU7RLF	7,000	8,100	14.7	9.3	7-25/32"H x 27-9/16"W x 24-13/32"D
133350	ARU9RLF	9,000	12,000	21.5	12.2	7-25/32"H x 27-9/16"W x 24-13/32"D
133351	ARU12RLF	12,000	16,000	20.0	11.5	7-25/32"H x 27-9/16"W x 24-13/32"D
133352	ARU18RLF	18,000	21,600	19.7	11.3	7-25/32"H x 35-7/16"W x 24-13/32"D
133353	ARU24RLF	24,000	27,000	14.7	9.3	7-25/32"H x 43-5/16"W x 24-13/32"D

Compact Cassette Indoor Heat Pump

- 2-Stage Turbo Fan
- Condensate Pump
- High Ceiling Mode
- Remote Temperature Sensor
- Auto Changeover
- Auto Restart/Reset
- Quiet Mode
- Auto Louver: Up/ Down
- Dry Mode
- Sleep Timer



Required compact cassette grille UTG-CCGF sold separately

Part#	Mfg#	Nom Cool	Nom Heat	SEER	HSPF	Dimensions
167719	AUU7RLF	7,000	8,100	--	--	9-11/16"H x 22-7/16"W x 22-7/16"D
133346	AUU9RLF	9,000	10,200	17.0	9.8	9-11/16"H x 22-7/16"W x 22-7/16"D
133347	AUU12RLF	12,000	13,500	17.0	9.8	9-11/16"H x 22-7/16"W x 22-7/16"D
133348	AUU18RLF	18,000	20,000	17.0	9.8	9-11/16"H x 22-7/16"W x 22-7/16"D

Cooling - Equipment & Rooftop Units

Multi Zone Mini-Split Systems

Floor-Mounted Indoor Heat Pump

- Wireless Remote Control
- Apple Catechin Filter
- Ion Deodorizing Filter
- Sleep Timer
- 24-Hour Timer
- Auto Louver: Up/Down
- Auto Mode
- Minimum Heat Mode
- Economy Mode
- Auto Restart/Reset
- Auto Changeover
- Powerful Mode



Part#	Mfg#	Nom Cool	Nom Heat	SEER	HSPF	Dimensions
163993	AGU9RLF	9,000	12,000	26.0	12.6	23-5/8"H x 29-1/8"W x 7-7/8"D
163998	AGU12RLF	12,000	16,000	22.7	11.6	23-5/8"H x 29-1/8"W x 7-7/8"D
164004	AGU15RLF	14,200	18,000	20.3	11.2	23-5/8"H x 29-1/8"W x 7-7/8"D

Cooling - Equipment & Rooftop Units

Single Zone Mini-Split Systems

Single Zone Wall-Mounted Type Mini-Split Systems

RL2 Wall-Mounted Mini-Split System

- 115V
- Up to 16 SEER
- Inverter technology
- Quiet operation
- Wireless remote controller
- Washable panel filter
- Smart system: auto mode
- Humidity control



Indoor Unit: ASU*RL2
Outdoor Unit: AOU*RL2

Part #	Mfg #	Nom Cool	Nom Heat	HSPF	SEER	EER	Components	Price
154248	9RL2	9,000	12,000	9.0	16	10.8	ASU9RL2 In, AOU9RL2 Out	
154249	12RL2	12,000	14,000	9.0	16	10	ASU12RL2 In, AOU12RL2 Out	

RLS3 Wall-Mounted High-SEER Mini Split System

- 208/230V
- Up to 33 SEER
- Energy saving program (ESP)
- Programmable remote
- Powerful heating
- World class performance
- Quiet operation
- Inverter technology



Indoor Unit: ASU*RLS3
Outdoor Unit: AOU*RLS3

Part #	Mfg #	Nom Cool	Nom Heat	HSPF	SEER	EER	Components	Price
172179	9RLS3	9,000	12,000	14.2	33.0	18.0	ASU9RLS3 In, AOU9RLS3 Out	
172185	12RLS3	12,000	16,000	14.0	29.3	15.2	ASU12RLS3 In, AOU12RLS3 Out	
172191	15RLS3	14,500	18,000	13.4	25.3	13.9	ASU15RLS3 In, AOU15RLS3 Out	

Cooling - Equipment & Rooftop Units

Single Zone Mini-Split Systems

RLS3H Wall-Mounted High-Heat Mini Split System

- 208/230V
- Up to 33 SEER
- Powerful heating down to -15°F outdoor temperatures
- Base freeze prevention
- Energy saving program (ESP)
- Programmable remote
- World class performance
- Quiet operation
- Inverter technology



Indoor Unit: ASU*RLS3
Outdoor Unit: AOU*RLS3H

Part #	Mfg #	Nom Cool	Nom Heat	HSPF	SEER	EER	Components	Price
172182	9RLS3H	9,000	12,000	14.0	33.0	18.0	ASU9RLS3 In, AOU9RLS3H Out	
172188	12RLS3H	12,000	16,000	13.8	29.3	15.2	ASU12RLS3 In, AOU12RLS3H Out	
172193	15RLS3H	14,500	18,000	13.3	25.3	13.9	ASU15RLS3 In, AOU15RLS3H Out	

RLFW1 Wall-Mounted HFI Mini Split System

- 208/230V
- Up to 23 SEER
- Inverter technology
- ENERGY STAR® qualified
- Clean air
- Quiet operation
- Wireless remote controller
- Washable panel filter
- Smart system: auto mode
- Humidity control



Indoor Unit: ASU*RLF1
Outdoor Unit: AOU*RLFW1

Part #	Mfg #	Nom Cool	Nom Heat	HSPF	SEER	EER	Components	Price
163988	9RLFW1	9,000	12,000	11.0	23.0	13.8	ASU9RLF1 In, AOU9RLFW1 Out	
163992	12RLFW1	12,000	16,000	11.0	22.0	12.5	ASU12RLF1 In, AOU12RLFW1 Out	

Cooling - Equipment & Rooftop Units

Single Zone Mini-Split Systems

RLXFW1 Wall-Mounted High SEER Mini Split System

- 208/230V
- Up to 20 SEER
- Inverter technology
- ENERGY STAR® qualified
- Clean air
- Quiet operation
- Wireless remote controller
- Washable panel filter
- Smart system: auto mode
- Humidity control



Indoor Unit: ASU*RLF
Outdoor Unit: AOU*RLXFW1

Part #	Mfg #	Nom Cool	Nom Heat	HSPF	SEER	EER	Components	Price
224795	24RLXFW1	22,000	25,200	10.6	19.5	12.5	ASU24RLF In, AOU24RLXFW1 Out	

RLXFWH Wall-Mounted High-Heat Mini Split System

- 208/230V
- Up to 20 SEER
- Inverter technology
- ENERGY STAR® qualified
- Clean air
- Quiet operation
- Wireless remote controller
- Washable panel filter
- Smart system: auto mode
- Humidity control



Indoor Unit: ASU*RLF
Outdoor Unit: AOU*RLXFWH

Part #	Mfg #	Nom Cool	Nom Heat	HSPF	SEER	EER	Components	Price
222876	18RLXFWH	18,000	21,600	10.4	20.0	13.3	ASU18RLF In, AOU18RLXFWH Out	
222879	24RLXFWH	22,000	25,200	10.5	19.5	12.5	ASU24RLF In, AOU24RLXFWH Out	

Cooling - Equipment & Rooftop Units

Single Zone Mini-Split Systems

RLXEH Wall-Mounted High-Heat Mini Split System

- 208/230V
- Up to 18.7 SEER
- Powerful heating down to -15°F outdoor temperatures
- Base freeze prevention
- Energy saving program (ESP)
- Programmable remote
- World class performance
- Quiet operation
- Inverter technology



Indoor Unit: ASU30RLE
Outdoor Unit: AOU30RLXEH

Part #	Mfg #	Nom Cool	Nom Heat	HSPF	SEER	EER	Components	Price
223027	30RLXEH	30,000	32,000	11.7	18.7	12.5	ASU30RLE In, AOU30RLXEH Out	

RLB/RLXB Wall-Mounted Mini Split System

- 208/230V
- Up to 19 SEER
- Inverter technology
- System 18RLB is ENERGY STAR® qualified
- Clean air
- Quiet operation
- Wireless remote controller
- Washable panel filter
- Smart system: auto mode
- Humidity control



Indoor Unit: ASU*RL(X)B
Outdoor Unit: AOU*RL(X)B

Part #	Mfg #	Nom Cool	Nom Heat	HSPF	SEER	EER	Components	Price
172857	18RLB	18,000	18,000	10.6	19.0	12.5	ASU18RLB In, AOU18RLB Out	
172860	24RLB	24,000	24,000	10.6	18.0	10.0	ASU24RLB In, AOU24RLB Out	
172863	30RLXB	30,000	30,000	9.0	16.5	9.5	ASU30RLXB In, AOU30RLXB Out	
172866	36RLXB	33,000	34,000	9.0	15.5	8.5	ASU36RLXB In, AOU36RLXB Out	

Cooling - Equipment & Rooftop Units

Single Zone Mini-Split Systems

Single Zone Floor/Ceiling Mount Type Multi-Split Systems

RULX Universal Floor/Ceiling-Mounted Mini Split System

- 208/230V
- Up to 16 SEER
- Can be mounted low on the wall or transverse mount the ceiling
- Inverter technology
- Wired remote controller UTY-RNBYU (optional)
- 4-Way auto louver for balanced comfort
- Smart system: auto mode
- Humidity control
- Fresh air intake



Indoor Unit: ABU*RULX
Outdoor Unit: AOU*RLX

Part #	Mfg #	Nom Cool	Nom Heat	HSPF	SEER	EER	Components	Price
185923	18RULX	17,800	21,500	8.5	16.0	10.9	ABU18RULX In, AOU18RLX Out	
100489	24RULX	22,200	24,000	8.5	15.0	9.9	ABU24RULX In, AOU24RLX Out	

RSLX Ceiling-Mount Mini Split System

- 208/230V
- Up to 14 SEER
- Inverter technology
- 4-Way auto louver for balanced comfort
- Smart system: auto mode
- Humidity control
- Fresh air intake
- Wired remote controller UTY-RNBYU (optional)



Indoor Unit: ABU36RSLX
Outdoor Unit: AOU36RLX

Part #	Mfg #	Nom Cool	Nom Heat	HSPF	SEER	EER	Components	Price
132106	36RSLX	34,100	36,500	8.5	14.0	8.1	ABU36RSLX In, AOU36RLX	

RLFF Floor-Mounted Mini Split System

- 208/230V
- Up to 26 SEER
- Compact size
- Energy efficient
- 2-Fan and wide airflow
- High performance heating
- Flexible and easy installation



Indoor Unit: AGU*RLF
Outdoor Unit: AOU*RLFF

Part #	Mfg #	Nom Cool	Nom Heat	HSPF	SEER	EER	Components	Price
163996	9RLFF	9,000	12,000	12.6	26.0	16.0	AGU9RLF In, AOU9RLFF Out	
164002	12RLFF	12,000	16,000	11.6	22.7	13.1	AGU12RLF In, AOU12RLFF Out	

Single Zone Mini-Split Systems

Single Zone Floor/Ceiling Mount Type Multi-Split Systems (Continued)

RLFF Floor-Mounted Mini Split System

Part #	Mfg #	Nom Cool	Nom Heat	HSPF	SEER	EER	Components	Price
164007	15RLFF	14,200	18,000	11.2	20.3	12.5	AGU15RLF In, AOU15RLFF Out	

RLFFH Floor-Mounted Mini Split System

- 208/230V
- Up to 26 SEER
- Compact size
- Energy efficient
- 2-Fan and wide airflow
- High performance heating
- Flexible and easy installation

Indoor Unit: AGU*RLF
 Outdoor Unit: AOU*RLFFH



Part #	Mfg #	Nom Cool	Nom Heat	HSPF	SEER	EER	Components	Price
163997	9RLFFH	9,000	12,000	12.4	26.0	16.0	AGU9RLF In, AOU9RLFFH Out	
164003	12RLFFH	12,000	16,000	11.3	22.7	13.1	AGU12RLF In, AOU15RLFFH Out	
164008	15RLFFH	14,200	18,000	11.0	20.3	12.5	AGU15RLF In, AOU15RLFFH Out	

Single Zone Slim Duct Multi-Split Systems

RLFCD Slim Duct Mini Split System

- 208/230V
- Up to 21.5 SEER
- Inverter technology
- 4-Way auto louver for balanced comfort
- Smart system: auto mode
- Humidity control
- Fresh air intake
- Wired remote controller UTY-RNBYU (optional)

Indoor Unit: ARU*RLF
 Outdoor Unit: AOU*RLFC



Part #	Mfg #	Nom Cool	Nom Heat	HSPF	SEER	EER	Components	Price
154772	9RLFCD	9,000	12,000	12.2	21.5	14.5	ARU9RLF In, AOU9RLFC Out	
154773	12RLFCD	12,000	16,000	11.5	20.0	12.8	ARU12RLF In, AOU12RLFC Out	
154774	18RLFCD	18,000	21,600	11.3	19.7	12.0	ARU18RLF In, AOU18RLFC Out	

Cooling - Equipment & Rooftop Units

Single Zone Mini-Split Systems

Single Zone Cassette Multi-Split Systems

RLFCC Compact Cassette Mini Split System

- 208/230V
- Up to 24 SEER
- Inverter technology
- High performance heating
- Cassette model fits into standard ceiling tile
- 2-Stage turbo fan
- Quiet operation
- Wired remote controller
- Smart system: auto mode
- Humidity control
- Fresh air intake



Indoor Unit: AUU*RLFCC
Outdoor Unit: AOU*RLFC

Part #	Mfg #	Nom Cool	Nom Heat	HSPF	SEER	EER	Components	Price
158386	9RLFCC	9,000	12,000	13.0	24.0	14.5	AUU9RLF In, AOU9RLFC Out	
158384	12RLFCC	12,000	16,000	12.2	21.9	12.8	AUU12RLF In, AOU12RLFC Out	
158383	18RLFCC	18,000	21,600	11.5	20.1	11.2	AUU18RLF In, AOU18RLFC Out	

RCLX Cassette Mini Split System

- 208/230V
- Up to 16 SEER
- Inverter technology
- Swing louvers
- 4-Way airflow system
- Simple maintenance
- Wired remote controller
- Energy saver
- Smart system: auto mode
- Humidity control
- Fresh air intake



Indoor Unit: AUU*RCLX
Outdoor Unit: AOU*RCLX

Part #	Mfg #	Nom Cool	Nom Heat	HSPF	SEER	EER	Components	Price
103324	18RCLX	17,800	21,000	8.5	16.0	11.1	AUU18RCLX In, AOU18RCLX Out	
103323	24RCLX	22,200	24,200	8.5	15.0	10.6	AUU24RCLX In, AOU24RCLX Out	
111989	36RCLX	34,100	36,000	8.5	14.0	8.1	AUU36RCLX In, AOU36RCLX Out	
106078	42RCLX	42,700	45,200	8.5	15.0	9.2	AUU42RCLX In, AOU42RCLX Out	

Cooling - Equipment & Rooftop Units

Packaged Terminal Air Conditioners

Packaged Terminal Air Conditioners

- Quiet operation
- High energy efficiency
- Digital control display
- Gold Fin™ anti-corrosion
- Auto restart
- Energy saver mode
- Front desk control
- Freeze room protection
- Dip switch setting for temperature limiting
- Temperature display on unit
- Fresh air ventilation, 70 CFM at 0.3 ESP with open damper door
- Dimensions: 16"H x 42"W x 19-7/8"D
- 5-Year parts and labor warranty on sealed refrigerant system
- 1-Year full system warranty on parts and labor, 5-year parts warranty



R-410A Heat/Cool PTAC

Part #	Mfg #	Cooling Capacity		Electric Heater (kW)	Air Circulation CFM, H/L	Dehumid (Pts/Hr)	Max Overcurrent Protection	Ship Wt	Price
		BTUH	EER						
141205	LP093CD3A	9,000/8,800	11.0	3.5/3.1	335/300	2.6	20	86.6 lbs	
141206	LP123CD3A	11,800/11,600	10.5	3.5/3.1	390/355	3.3	20	97.1 lbs	
141207	LP153CD3A	14,300/14,100	9.2	3.5/3.1	390/355	4.4	20	118.1 lbs	
141208	LP153CD5A	14,100/14,300	9.2	4.6/5.0	388/353	4.4	30	118.1 lbs	

R-410A Heat Pump PTAC

Part #	Mfg #	Cooling Capacity		Heating Capacity		Electric Heater (kW)	Air Circulation CFM, H/L	Dehumid (Pts/Hr)	Max Overcurrent Protection	Ship Wt	Price
		BTUH	EER	BTUH	COP						
141210	LP093HD3A	9,000/8,800	11.0	8,100/7,900	3.2	3.5/3.1	335/300	2.6	20	101 lbs	
141212	LP123HD3A	11,800/11,600	10.6	10,800/10,600	3.2	3.5/3.1	390/355	3.3	20	101 lbs	
141213	LP153HD3A	14,700/14,500	9.4	12,100/11,900	2.6	3.5/3.1	390/355	4.4	20	109 lbs	

PTAC Accessories

Drain Kit



Part #	Mfg #	Description	Price
141218	AYDR101	Drain Kit Interior/Exterior	

Cooling - Equipment & Rooftop Units

Packed Terminal Air Conditioners



AYRGALA01

Grille



AYAGALA01A

Part #	Mfg #	Description	Price
141217	AYRGALA01	42" Large Stamp Grille	
144096	AYAGALA01A	42" Aluminum Architectural Grille	

Sleeve



Part #	Mfg #	Description	Price
141216	AYSVB01A	42" Large Wall Sleeve	

PTAC Accessory Kit

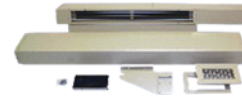

Part #	Mfg #	Description	Price
145162	AYLD1A	Lateral Duct Kit	

Cooling - Equipment & Rooftop Units

Packaged Terminal Air Conditioners

PTAC Units

- Features:
 - Enhanced dehumidification to lengthen cooling cycles
 - Low temperature protection
 - Continuous fan operation or fan cycling governed by thermostat
 - Condensate dispersion
 - Filtered ventilation
 - Clearly labeled digital controls
 - Electronic temperature limiter with (4) pre-programmed temperature ranges
 - Random restart
- Units come with "Smart Controls" to add optional front desk control and remote thermostats
- 5-Year warranty on compressor, 1-year warranty on parts



Heat Pump with Electric Heat - R-410A

Part #	Mfg #	Voltage	BTUH	Heat	Price
133113	EKTH09-1G3KW	208/230V	9,000	3kW	
133108	EKTH12-1G	208/230V	12,000	No Heat	
133116	EKTH12-1G5KW	208/230V	12,000	5kW	
133109	EKTH15-1G	208/230V	15,000	No Heat	
133119	EKTH15-1G5KW	208/230V	15,000	5kW	

PTAC Accessories

Part #	Mfg #	Description	Price
133092	7602-501	42" Stamped Grille	
133090	7602-530A-230	5kW 30A 265V Power Cord for EKTC12-2G, EKTH12-2G, EKTC15-2G & EKTH15-2G	



Roof Top Units

Commercial Series™ Package Gas/Electric Units

13 SEER R-410A High Efficiency Commercial Series™ Package Gas/Electric - RKNL-A 3 to 5 Ton

- Scroll compressors with internal line break overload and high pressure protection
- Single stage compressor
- Convertible airflow
- TXV Refrigerant metering system on each circuit
- High pressure and low pressure/loss of charge protection
- Solid core liquid line filter-drier on each circuit
- Single slab, single pass designed evaporator and condenser coils
- Cooling operation up to 125°F ambient
- Foil faced insulation encapsulated throughout entire unit
- Cabinet features a durable powder-paint finish, steel coated on each side
- One-piece top cover and one-piece base pan with drawn supply and return opening for superior water management
- Externally mounted refrigerant gauge ports
- Forkable base rails
- Single point electrical and gas connections
- 1" Filter standard with slide out design, will accept 2" filter
- 1-Stage gas valve, direct spark ignition, and induced draft
- Tubular heat exchanger
- Solid state furnace control with on-board diagnostics
- Colored and labeled wiring
- Copper tube/aluminum fin indoor coil
- Direct drive or high performance belt drive motor with variable pitch pulleys and quick adjust belt system
- Energy Star® rated
- Drive package:
 - RKNL-XXXXXK: Direct drive
 - RKNL-XXXXXL: Belt drive
- 5-Year limited compressor warranty (commercial)
- 10-Year warranty on factory standard heat exchanger (commercial)
- 1-Year limited parts warranty (commercial)
- 20-Year warranty on stainless steel heat exchanger (commercial)



Cooling - Equipment & Rooftop Units

Part #	Mfg #	Tons	Gross Cooling BTUH	Heating Input BTUH	Electrical	Unit Dimensions H x W x D	Ship Wt	Price
174995	RKPN-A036JK08EAJA	3.0	36,800	80,000	208/230-1-60	35" x 75-17/32" x 46-1/2"	550 lbs	
174996	RKPN-A048JK10EAJA	4.0	50,500	100,000	208/230-1-60	35" x 75-17/32" x 46-1/2"	587 lbs	
116742	RKNL-A048JK13E	4.0	50,500	135,000	208/230-1-60	35" x 75-17/32" x 46-1/2"	592 lbs	
174997	RKPN-A060JK13EAJA	5.0	61,500	135,000	208/230-1-60	35" x 75-17/32" x 46-1/2"	604 lbs	
162121	RKNN-A036CK08EAJA	3.0	36,600	80,000	208/230-3-60	35" x 75-17/32" x 46-1/2"	550 lbs	
162127	RKNN-A048CK10EAJA	4.0	50,500	100,000	208/230-3-60	35" x 75-17/32" x 46-1/2"	587 lbs	
162131	RKNN-A060CK10E	5.0	61,500	100,000	208/230-3-60	35" x 75-17/32" x 46-1/2"	597 lbs	
162133	RKNN-A060CK13EAJA	5.0	61,500	135,000	208/230-3-60	35" x 75-17/32" x 46-1/2"	604 lbs	
162136	RKNN-A060DL13EAJA	5.0	61,500	135,000	460-3-60	35" x 75-17/32" x 46-1/2"	604 lbs	



Roof Top Units

13 SEER R-410A High Efficiency Commercial Series™ Package Gas/Electric Rooftop - RKNL-B 6 to 12.5 Ton

- Scroll compressors with internal line break overload and high pressure protection
- Single stage compressor on 6 ton models, dual stage compressor on 7.5 to 12.5 models
- Convertible airflow
- TXV Refrigerant metering system on each circuit except 6 ton model
- High pressure and low pressure/loss of charge protection
- Solid core liquid line filter-drier on each circuit
- Single slab, single pass designed evaporator and condenser coils
- Cooling operation up to 125°F ambient
- Foil faced insulation encapsulated throughout entire unit
- Cabinet features a durable powder-paint finish, steel coated on each side
- Slide out indoor fan assembly
- One-piece top cover and one-piece base pan with drawn supply and return opening for superior water management
- Forkable base rails
- Single point electrical and gas connections
- Internally sloped slide out condensate pan conforms to ASHRAE 62 standard
- 2" Filter standard with slide out design
- 2-Stage gas valve, direct spark ignition, and induced draft
- Tubular heat exchanger
- Solid state furnace control with on-board diagnostics
- Colored and labeled wiring
- Copper tube/aluminum fin indoor coil (12-1/2 ton uses Micro-Channel condenser)
- High performance belt drive motor with variable pitch pulleys and quick adjust belt system
- Electronic ignition
- Energy Star® rated
- Drive package:
 - RKNL-XXXXXL: Belt drive
 - RKNL-XXXXXM: Belt drive high static
- 5-Year limited compressor warranty (commercial)
- 10-Year on factory standard heat exchanger (commercial)
- 1-Year limited parts warranty (commercial)
- 1-Year limited on condenser coil and evaporator coil leaks caused by factory defects (commercial)



Cooling - Equipment & Rooftop Units

Part #	Mfg #	Tons	Gross Cooling BTUH	Heating Input BTUH	Electrical	Unit Dimensions H x W x D	Ship Wt	Price
158370	RKNL-B090CM15EAJA	7.5	93,000	150,000	208/230-3-60	40-3/16" x 93-11/16" x 58-3/4"	1,054 lbs	
159031	RKNL-B090DL15EAJA	7.5	93,000	150,000	460-3-60	40-3/16" x 93-11/16" x 58-3/4"	1,062 lbs	
158371	RKNL-B090CM22EAJA	7.5	93,000	225,000	208/230-3-60	40-3/16" x 93-11/16" x 58-3/4"	1,090 lbs	
158372	RKNL-B120CL22EAJA	8.5	101,000	225,000	208/230-3-60	40-3/16" x 93-11/16" x 58-3/4"	1,132 lbs	



Roof Top Units

13 SEER R-410A High Efficiency Commercial Series™ Package Gas/Electric Rooftop - RKNL-B 6 to 12.5 Ton Economizer

- Scroll compressors with internal line break overload and high pressure protection
- Single stage compressor on 6 ton models, dual stage compressor on 7.5 to 12.5 models
- Convertible airflow
- TXV Refrigerant metering system on each circuit except 6 ton model
- High pressure and low pressure/loss of charge protection
- Solid core liquid line filter-drier on each circuit
- Single slab, single pass designed evaporator and condenser coils
- Cooling operation up to 125°F ambient
- Foil faced insulation encapsulated throughout entire unit
- Cabinet features a durable powder-paint finish, steel coated on each side
- Slide out indoor fan assembly
- One-piece top cover and one-piece base pan with drawn supply and return opening for superior water management
- Forkable base rails
- Single point electrical and gas connections
- Internally sloped slide out condensate pan conforms to ASHRAE 62 standard
- 2" Filter standard with slide out design
- 2-Stage gas valve, direct spark ignition, and induced draft
- Tubular heat exchanger
- Solid state furnace control with on-board diagnostics
- Colored and labeled wiring
- Copper tube/aluminum fin indoor coil (12-1/2 ton uses Micro-Channel condenser)
- High performance belt drive motor with variable pitch pulleys and quick adjust belt system
- Electronic ignition
- Energy Star® rated
- JBA - Factory installed stainless steel heat exchanger and service disconnect
- Drive package:
 - RKNL-XXXXXL: Belt drive
 - RKNL-XXXXXM: Belt drive high static
 - RKNL-XXXXXN: Belt drive high static (B090 Only)
- 5-Year limited compressor warranty (commercial)
- 10-Year warranty on factory standard heat exchanger (commercial)
- 1-Year limited parts warranty (commercial)
- 1-Year limited warranty on condenser coil and evaporator coil leaks caused by factory defects (commercial)



Cooling - Equipment & Rooftop Units

Part #	Mfg #	Tons	Gross Cooling BTUH	Heating Input BTUH	Electrical	Unit Dimensions H x W x D	Ship Wt	Price
147988	RKNL-B090CM22EJBA	7.5	93,000	225,000	208/230-3-60	44" x 93-11/16" x 58-3/4"	1,090 lbs	



Roof Top Units

13 SEER R-410A High Efficiency Commercial Series™ Package Gas/Electric Rooftop - RKNL-B 6 to 12.5 Ton Economizer with Clear Control™ and HumidiDry™ Technology

- Scroll compressors with internal line break overload and high pressure protection
- Single stage compressor on 6 ton models, dual stage compressor on 7.5 to 12.5 models
- Convertible airflow
- TXV Refrigerant metering system on each circuit except 6 ton model
- High pressure and low pressure/loss of charge protection
- Solid core liquid line filter-drier on each circuit
- Single slab, single pass designed evaporator and condenser coils
- Cooling operation up to 125°F ambient
- Foil faced insulation encapsulated throughout entire unit
- Cabinet features a durable powder-paint finish, steel coated on each side
- Slide out indoor fan assembly
- One-piece top cover and one-piece base pan with drawn supply and return opening for superior water management
- Forkable base rails
- Single point electrical and gas connections
- Internally sloped slide out condensate pan conforms to ASHRAE 62 standard
- 2" Filter standard with slide out design
- 2-Stage gas valve, direct spark ignition, and induced draft
- Tubular heat exchanger
- Solid state furnace control with on-board diagnostics
- Colored and labeled wiring
- Copper tube/aluminum fin indoor coil (12-1/2 ton uses Micro-Channel condenser)
- High performance belt drive motor with variable pitch pulleys and quick adjust belt system
- Electronic ignition
- Factory installed ClearControl™, a Direct Digital Control (DDC) and sensors which can connect to LonWorks™ or BACnet® BAS systems for remote monitoring and control.
- Variable frequency drive (VFD) belt drive high static
- HumidiDry™ dehumidification system
- Energy Star® rated
- Factory installed hail guard, heat exchanger, service disconnect, and comfort alert with DDC single enthalpy economizer
- 5-Year limited compressor warranty (commercial)
- 10-Year warranty on factory standard heat exchanger (commercial)
- 1-Year limited parts warranty (commercial)
- 1-Year limited warranty on condenser coil and evaporator coil leaks caused by factory defects (commercial)



Cooling - Equipment & Rooftop Units

Part #	Mfg #	Tons	Gross Cooling BTUH	Heating Input BTUH	Electrical	Unit Dimensions H x W x D	Ship Wt	Price
150303	RKNL-G090CT22EDPH	7.5	93,000	225,000	208/230-3-60	44" x 93-11/16" x 58-3/4"	1,137 lbs	



Roof Top Units

11.2 SEER R-410A Standard Efficiency Commercial Series™ Package Gas/Electric Rooftop - RKKL-B 7.5 to 12.5 Ton

- Scroll compressors with internal line break overload and high pressure protection
- 1-Stage compressor on 7.5 and 10 ton models, 2-Stage compressor on 12.5 ton model
- Convertible airflow
- Fixed restriction refrigerant flow control on 7.5 and 10 ton models, TXV on 12.5 ton model
- High pressure and low pressure/loss of charge protection
- Solid core liquid line filter-drier on each circuit
- Single slab, single pass designed evaporator and condenser coils
- Cooling operation up to 125°F ambient
- Foil faced insulation encapsulated throughout entire unit
- Cabinet features a durable powder-paint finish, steel coated on each side
- One-piece top cover indoor section and one-piece base pan
- Forkable base rails
- Single point electrical and gas connections
- 2" Filter standard with slide out design
- 2-Stage gas valve, direct spark ignition, and induced draft
- Tubular heat exchanger
- Solid state furnace control with on-board diagnostics
- Colored and labeled wiring
- Copper tube/aluminum fin indoor coil
- Aluminum Micro-Channel outdoor coil(s)
- High performance belt drive motor with variable pitch pulleys and quick adjust belt system
- Electronic ignition
- Drive package:
 - RKKL-XXXXXL: Belt drive
- 5-Year limited compressor warranty (commercial)
- 10-Year warranty on factory standard heat exchanger (commercial)
- 1-Year limited parts warranty (commercial)
- 1-Year limited warranty on condenser coil and evaporator coil leaks caused by factory defects (commercial)



Cooling - Equipment & Rooftop Units

Part #	Mfg #	Tons	Gross Cooling BTUH	Heating Input BTUH	Electrical	Unit Dimensions H x W x D	Ship Wt	Price
142306	RKKL-B090CL22E	7.5	87,000	225,000	208/230-3-60	44" x 93-11/16" x 58-3/4"	955 lbs	
140163	RKKL-B120CL22E	10.0	123,000	225,000	208/230-3-60	44" x 93-11/16" x 58-3/4"	1,057 lbs	



Roof Top Units

Roof Top Unit Accessories (Continued)

Louver Panel Kits

Part #	Mfg #	Description	Price
149483	AXRX-AAD01B	For 6-12.5 Ton Package Units, Green	

VRF Equipment

Mini-Split VRF Air Conditioner Systems

- All systems use R-410A refrigerant
- 6-Year compressor warranty
- 2-Year parts warranty

21.7 IEER AIRSTAGE® V-II Series Commercial Multi Air Conditioning System

- Allow control of the air conditioning in each room individually
- Round corner type high density multi-path heat exchanger
- Sine wave DC inverter control
- Centralized remote control system



Part #	Mfg #	Nom Cool BTUH	Nom Heating BTUH	Electrical	Dimensions	Price
147753	AQUA72RLBV	72,000	81,000	208/230-3-60	66.54"H x 36.61"W x 30.12"D	
147755	AQUA96RLBV	96,000	108,000	208/230-3-60	66.54"H x 36.61"W x 30.12"D	
167174	AQUA72TLBV	72,000	81,000	208/230-3-60	66.54"H x 36.61"W x 30.12"D	
167176	AQUA96TLBV	96,000	108,000	208/230-3-60	66.54"H x 36.61"W x 30.12"D	
173046	AQUA120TLBV	120,000	135,000	208/230-3-60	66.54"H x 48.82"W x 30.12"D	

Vertical Air Handler

- Selectable capacities from 1 to 5 tons
- Broad static pressure range for a wide range of applications
- Durable power-coated thick steel gauge cabinet
- Acoustical and thermal insulation is upgraded from 1/2" to 1" thick to reduce heat loss
- Equipped with standard MERV 3 filter
- Easily retrofitted into existing installations



Cooling - Equipment & Rooftop Units

Part #	Mfg #	Nom Cool BTUH	Nom Heating BTUH	Electrical	Dimensions	Price
185656	ARUV12TLAV	12,000	13,500	208/230-3-60	51"Hx17-11/16"Wx23-13/16"D	
185658	ARUV18TLAV	18,000	20,000	208/230-3-60	51"Hx17-11/16"Wx23-13/16"D	
185659	ARUV24TLAV	24,000	27,000	208/230-3-60	51"Hx17-11/16"Wx23-13/16"D	
185660	ARUV30TLAV	30,000	24,000	208/230-3-60	51"Hx22-3/16"Wx23-13/16"D	

Indoor Slim Duct Air Handler Unit



Part #	Mfg #	Nom Cool BTUH	Type	Price
147768	ARUL7RLAV	7,000	Slim Duct, Heat Pump	
147769	ARUL9RLAV	9,000	Slim Duct, Heat Pump	
147770	ARUL12RLAV	12,000	Slim Duct, Heat Pump	
147772	ARUL18RLAV	18,000	Slim Duct, Heat Pump	

VRF Equipment

Mini-Split VRF Air Conditioner Systems (Continued)

Vertical Air Handler

Indoor Slim Duct Air Handler Unit

Part #	Mfg #	Nom Cool BTUH	Type	Price
147773	ARUL24RLAV	24,000	Slim Duct, Heat Pump	
173049	ARUL18TLAV	18,000	Slim Duct, Heat Recovery	

Duct Air Handler Unit

- Slim and compact design
- Easy maintenance
- Easy installation
- Two-direction drain piping



Part #	Mfg #	Nom Cool BTUH	Type	Price
147774	ARUM30RLAV	30,000	Duct, Heat Pump	
173071	ARUM24TLAV	24,000	Duct, Heat Recovery	
173050	ARUM30TLAV	30,000	Duct, Heat Recovery	
173051	ARUM36TLAV	36,000	Duct, Heat Recovery	

Indoor Wall-Mounted Air Handler Unit



Part #	Mfg #	Nom Cool BTUH	Type	Price
147785	ASUA7RLAV	7,000	Compact Wall-Mounted, Heat Pump	
147786	ASUA9RLAV	9,000	Compact Wall-Mounted, Heat Pump	
147787	ASUA12RLAV	12,000	Compact Wall-Mounted, Heat Pump	
174051	ASUA9TLAV	9,000	Compact Wall-Mounted, Heat Recovery	
181051	ASUA12TLAV	12,000	Compact Wall-Mounted, Heat Recovery	
181053	ASUA14TLAV	14,000	Compact Wall-Mounted, Heat Recovery	
181054	ASUB18TLAV	18,000	Wall-Mounted, Heat Recovery	
181047	ASUB24TLAV	24,000	Wall-Mounted, Heat Recovery	
147789	ASUB18RLAV	18,000	Wall-Mounted, Heat Pump	
147790	ASUB24RLAV	24,000	Wall-Mounted, Heat Pump	

Indoor Ceiling Cassette Air Handler Unit



Part #	Mfg #	Nom Cool BTUH	Type	Price
147756	AUUA7RLAV	7,000	Compact Ceiling Cassette, Heat Pump	
147758	AUUA9RLAV	9,000	Compact Ceiling Cassette, Heat Pump	
147759	AUUA12RLAV	12,000	Compact Ceiling Cassette, Heat Pump	
147760	AUUA14RLAV	14,000	Compact Ceiling Cassette, Heat Pump	
147761	AUUA18RLAV	18,000	Compact Ceiling Cassette, Heat Pump	
147762	AUUA24RLAV	24,000	Compact Ceiling Cassette, Heat Pump	

VRF Equipment

Mini-Split VRF Air Conditioner Systems (Continued)

Vertical Air Handler

Indoor Ceiling Cassette Air Handler Unit

Part #	Mfg #	Nom Cool BTUH	Type	Price
173047	AUUA7TLAV	7,000	Compact Ceiling Cassette, Heat Recovery	
173048	AUUA12TLAV	12,000	Compact Ceiling Cassette, Heat Recovery	
181048	AUUA24TLAV	24,000	Compact Ceiling Cassette, Heat Recovery	
147766	AUUB30RLAV	30,000	Ceiling Cassette, Heat Pump	

Indoor High Static Pressure Duct Air Handler Unit



Part #	Mfg #	Nom Cool BTUH	Type	Price
173072	ARUH36TLAV	36,000	High Static Pressure Duct, Heat Recovery	
173052	ARUH48TLAV	48,000	High Static Pressure Duct, Heat Recovery	
173054	ARUH60TLAV	60,000	High Static Pressure Duct, Heat Recovery	
181055	ARUH96TLAV	96,000	High Static Pressure Duct, Heat Recovery	

Mini-Split VRF System Remotes

UTY-RNKU Wired Remote Control for VRF Units



Part #	Mfg #	Description	Price
147803	UTY-RNKU	VRF Wired Remote Control	
166394	UTY-RNRU	VRF Individual Touch Panel Controller Wired Remote	
147806	UTY-DCGY	VRF Central Remote Control	
147802	UTY-LNHU	VRF Wireless Remote Control	
181050	UTY-PLGXR1	VRF Centralized Remote Control option for UTY-ALGX Software	

Mini-Split VRF System Parts & Accessories

Part #	Mfg #	Description	Price
133356	UTP-SX248A	Separation Tube	
147827	UTR-BP090X	VRF Indoor Separation Tube	
147826	UTR-BP180X	VRF Indoor Separation Tube	
147825	UTR-BP567X	VRF Indoor Separation Tube	
147828	UTR-CP567X	VRF Outdoor Separation Tube	
133349	UTG-CCGF	Compact Cassette Grille for AUU Units	
147757	UTG-CCGV	Compact Cassette Grille for Airstage V-II Units	
147763	UTG-LCGV	Cassette Grille for Airstage V-II Units	
173055	UTP-BX090A	Ind Separation Tube 90 or less MBU Capacity	

VRF Equipment

Mini-Split VRF System Parts & Accessories (Continued)

Part #	Mfg #	Description	Price
173056	UTP-BX180A	Ind Separation Tube 90-180 MBU Capacity	
173057	UTP-BX567A	Ind Separation Tube 180 or more MBU Capacity	
173058	UTP-DX567A	Outdoor Unit Branch Kit	
173059	UTP-RU01AH	Refrigeration Branch Unit - Single Type 20k or Less	
173060	UTP-RU01BH	Refrigeration Branch Unit - Single Type 60k or Less	
181056	UTP-RU01CH	Refrigeration Branch Unit - Single Type 96k or Less	
173061	UTP-RU04BH	Refrigeration Branch Unit - Multi Type 191k or less	
147829	UTR-H0906L	VRF Header (6) Straight Connects	
147830	UTR-H1806L	VRF Header (6) "L" Connects	
147831	UTR-H0908L	VRF Header (8) Straight Connects	
147832	UTR-H1808L	VRF Header (8) "L" Connects	
181049	UTY-ALGX	VRF System Controller Lite Software	
147818	UTY-ABGX	VRF BACnet® Gateway Software	
147823	UTY-ASGX	VRF Service Tool (Software)	
185661	UTY-VSGXZ1	VRF Signal Amplifier	
133361	UTY-XCBXZ1	HFI Interface Kit	
147844	UTZ-PX1NBA	Drain Pump Unit (Duct Type)	
147847	UTZ-KXGC	Insulation Kit for High Humidity	
151930	UTZ-VXAA	Fresh Air Intake for Compact Cassette Type	

Cooling - Equipment & Rooftop Units



Brass Sealing Caps

Sealing Caps

Brass Sealing Cap - Hex Head Flare Fitting



Part #	Mfg #	Size	Qty	Price
140748	82-A04544	1/4"	50	
140749	82-A04545	3/8"	25	

Brass Sealing Cap - Serrated Head Flare Fitting

Part #	Mfg #	Size	Price
140746	82-A16447	1/4"	

Protective Cap - Brass w/o Core Removal Tool

Part #	Mfg #	Description	Price
126195	83-CD2245-6PK	Protective Cap - Brass w/o Core Removal Tool 6/Pk	

Cooling - Accessories

Chemicals

Coil Cleaners

Evap Foam® Coil Cleaner

- High performance detergent with special surfactants and alkaline cleaners, foaming
- "No rinse required" condenser coil cleaner
- Spray right side up or upside down
- For cooling or evaporator coils



Part #	Mfg #	Description	Price
139433	4171-75	18 oz Aerosol	

Nu-Brite® Coil Cleaner

- Foaming coil cleaner
- Brightens as it cleans
- Safer than acids
- Biodegradable, USDA approved



4291-18



4291-08

Part #	Mfg #	Description	Price
139431	4291-18	18 oz Aerosol	
139434	4291-08	1 gal	

Nu-Blast® Coil Cleaner

- "No rinse required" condenser coil cleaner
- High pressure blast plus solvent cleaning



Part #	Mfg #	Description	Price
139432	4290-75	18 oz Aerosol	

Rx11-Flush®

- Ozone-safe solvent for flushing refrigeration and air conditioning systems/line sets
- Rinses away particulate, sludge, carbon residues, acids, oils and water



4300-09



4300-11



4300-50



4300-89

Part #	Mfg #	Description	Price
114154	4300-09	1 lb Canister	
114155	4300-11	2 lb Canister	
114158	4300-50	Flushing Tool	
139863	4300-89	Injection Valve	

A/C Re-New Lubricant

- Enhances the lubricity and thermal properties of the refrigeration oil when introduced to an a/c or refrigeration system
- Reduces energy consumption
- Improves heat transfer in evaporator and condenser by improving oil return



Part #	Mfg #	Description	Price
170384	4057-55	4 oz liquid	

Rx-Acid Scavenger®

- Neutralizes or "scavenges" acid in refrigeration, air conditioning systems
- Use after burnouts or normal maintenance
- Normal dosage is 2 fl oz/gallon of system oil



Part #	Mfg #	Description	Price
140754	4301-02	2 oz Liquid, Boxed	

Chemicals

Refrigerant Leak Sealant

A/C EasySeal

- Prevents refrigerant leaks and seals existing leaks in air conditioning and refrigeration systems
- Eliminates expensive leak search and repair
- Travels with refrigerant to find leaks fast



Part #	Mfg #	Description	Price
133636	4050-06	3 oz Pressurized Can	

Chemicals

Cleaners
Evaporator Coil Cleaner



Part #	Mfg #	Description	Price
092115	85-C02	Aerosol Evaporator Coil Cleaner	

Enviro-Coil Cleaner

- Cleans evaporator and condenser coils
- No foaming action, only attacks dirt buildup
- Environmentally safe
- No rinsing required on evaporator coils
- (4) Containers per case
- USDA Accepted



Part #	Mfg #	Description	Price
141525	85-H-EC01	1 gal Enviro-Coil Cleaner	

Cal-Brite Coil Cleaner

- Low pH cleaner for cleaning evaporator coils, air-cooled condensers, and other finned cooling and heating coils
- Based upon glycolic acid and other ingredients, including Merpol®
- Provides moderate foaming and brightening
- Safe for indoor and outdoor use



Part #	Mfg #	Description	Price
176312	4133-08	1 Gal, 3:1 Concentration	

Pro-Treat® 152 King-Size Premium Condensate Drain Pan Treatment

- Economical, safe, effective king-size tablets last three times longer
- Safe, non-corrosive, odor-free and 100% soluble
- Computer room approved
- Keeps drain pans and condensate lines clean and free flowing
- Dosage: 1 tablet per 3 tons per 3 months



Part #	Mfg #	Description	Price
149945	853002	(12) Tablets per Jar	

Leak Freeze
A/C Leak Freeze

- Permanently seals leaks in air conditioning and refrigeration systems
- Does not contain polymers
- Not activated by moisture or oxygen
- Non-clogging to A/C compressor and recovery unit



Part #	Mfg #	Description	Price
149068	00284	1.5 oz Cartridge, Clamshell w/Adapter	

Chemicals

Coil Cleaners

Self-Rinsing Evaporator Coil Cleaner

- *No foaming action – only attacks dirt build-up, not metal*
- *Rinsing not required – normal condensation will carry away dirt and contamination*
- *May irritate eyes and skin – excessive contact should be avoided*
- *USDA Accepted*



Part #	Mfg #	Size	Color	Price
041217	85-401	1 gal	Green	

Heavy Foaming Acid Condenser Coil Cleaner & Brightener

- *Expanding foam action*
- *Best for brightening – makes condenser coils look new*
- *Must be thoroughly rinsed with water*
- *Contains hazardous components hydrofluoric acid and phosphoric acid*
- *Outdoor use only, protective gloves, and eye/face protection required*



Part #	Mfg #	Size	Color	Price
041756	85-501	1 gal	Red	

Heavy Foaming Alkaline Condenser Coil Cleaner & Brightener

- *Expanding foam action*
- *Alkaline formulation is excellent on greasy coils*
- *Must be thoroughly rinsed with water*
- *Contains hazardous component potassium hydroxide*
- *Good ventilation, protective gloves, and eye protection required*
- *USDA Accepted*



Part #	Mfg #	Size	Color	Price
041334	85-1101	1 gal	Orange	

Cooling - Accessories

Chemicals

Refrigerant Recovery

Pro-Flush HVAC Flushing Solvent

- HVAC/R Flushing solvent for R-410A retrofits, refrigerant conversions and retrofits
- Low toxicity
- Non-flammable
- Residue-free



Part #	Mfg #	Description	Price
134797	PF-16	16 oz Refill	
134796	PF KIT	Power Flush Kit	

Chemicals

ParFlush Kits

ParFlush Kit for System Conversion & Clean-Up

- *Developed for refrigerant systems up to eight tons*
- *Ideal for R-410A conversions or system clean-up of air conditioning, heat pump or refrigeration systems with 3/8" OK liquid line sets*
- *Non-toxic and non-flammable*



Part #	Mfg #	Description	Price
139317	PFKIT1	1 lb Kit	

Refrigerant & Recovery Cylinders

Refrigeration Chemicals

Mineral Refrigeration Lubricant

- Viscosity 150 SUS (ISO VG 32) replaces 3GS
- Viscosity 300 SUS *(ISO VG 68) replaces 4GS
- For use with CFC and HCFC refrigerants
- Refined from select naphthenic base oils
- Wax free and oem approved
- Highest quality available and long-term, trouble-free service
- Low temperature properties
- (6) Containers per package



H-2301



H-2401

Part #	Mfg #	Description	Price
104480	85-H-2301	1 gal, 150 Viscosity	
149944	85-H-2401	1 gal, 300 Viscosity	

Condensate Neutralizers

Cooling Tower & Water Treatment Products

pH-TREAT™ pH Neutralizer

- Neutralizes condensate water raising the pH to near neutral
- Includes:
 - (1) C-Clip for mounting
 - (2) 1/2" Barb x 3/8" MPT fittings
 - (2) 3/4" FPT x 3/8" MPT fittings
- Designed for gravity feed
- Product life is expected to have 1-year service life
- Temperature range: 40° to 100°F
- Pressure range: 0 to 125 psi



Part #	Mfg #	Description	Price
148176	4720-06	2.5" x 12" Cartridge Housing with 3/8" FPT Connections	

Condensate Drain Guns

Condensate Drain Cleaners

Charles Gallo Drain Gun

- Clears condensate drains with a SWOOSH CO2 cartridge
- Lightweight, portable
- Creates 1,200 psi pressure
- Includes a tapered fitting to fit on 3/8" - 3/4" drain openings
- Cartridges are environmentally safe and recyclable



Part #	Mfg #	Description	Price
142154	GG-1	Gallo Gun with SWOOSH CO2 Cartridge	

Swoosh CO2 Cartridge



Part #	Mfg #	Description	Price
142156	GGC-12	Replacement Cartridge for SWOOSH CO2, 12/Pk	

Condensate Drain Pan Switches

Condensate Overflow Switches

Condensate Cop™ Clamp-On Float Switch

- Large over clamping area that fits the edge of all types of drain pans
- Separate float/probe assembly swivels to position switch
- Switch opens when rising water presents a flooding condition
- 2-Wire connection
- 24V/1.5A NC Reed switch
- Includes:
 - 5' Leads
 - Wire nuts
 - Clamping screws



Part #	Mfg #	Description	Price
148951	CC-1	Drain Pan Switch	

Condensate Traps

Condensate Traps

100 Series Plain Clear Condensate Trap

- Patented "See-Through" technology
- Watertight lower cap opens for easy access to clean drain pan outlet inside unit
- Remove upper cap to completely clean in seconds
- Cap can be replaced with optional float switch to warn owner if blockage is detected
- 3-Year warranty



Part #	Mfg #	Description	Price
147440	EZT-113B	3/4" Blow Molded Trap w/Brush	
119480	EZT-119	1" Blow Molded Trap w/Brush	



Condensate Traps

Condensate Overflows

Condensate Overflow Safety Switch



84-SS2

Part #	Mfg #	Description	Price
114920	84-SS2	Condensate Overflow Safety Switch - Auxiliary Drain Line Mount	
079708	84-SS3	Condensate Overflow Safety Switch - Pan Mount	

Secondary Drain Pans

Condensate Drain Pans

A/C Secondary Condensate Drain Pan

- *Rolled edges for durability*
- *Ribbed bottoms for rigidity*
- *Includes 3/4" PVC fittings*



Part #	Mfg #	Bottom Dimensions	Drain Line Outlets	Price
040019	6-3060L	30" x 60" x 2"	Long	



Condenser Pads

Vibration Pads

Super W Rubber Vibration Pad

- 2" Modular design

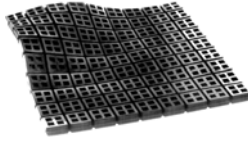

Part #	Mfg #	Size	Price
029150	SW2X2SW	2" x 2" x 3/4"	
027466	R18X18SW	18" x 18" x 3/4"	

Condenser Pads

E-Lite™ Plastic Equipment Pads

- Molded with size label and symbol representing content of recycled material
- Rounded edges and concrete gray color
- Limited lifetime warranty



2" E-Lite™ Equipment Pad

Part #	Mfg #	Size	Price
023182	EL2424-2	24" x 24" x 2"	
122773	EL2430-2	24" x 30" x 2"	
021931	EL2436-2	24" x 36" x 2"	
023183	EL3030-2	30" x 30" x 2"	
023229	EL3036-2	30" x 36" x 2"	
023184	EL3040-2	30" x 40" x 2"	
039431	EL3232-2	32" x 32" x 2"	
023185	EL3636-2	36" x 36" x 2"	
039688	EL3640-2	36" x 40" x 2"	
021932	EL3648-2	36" x 48" x 2"	

3" E-Lite™ Equipment Pad

Part #	Mfg #	Size	Price
147199	EL1838-2	18" x 38" x 3"	
110904	EL2424-3	24" x 24" x 3"	
122936	EL3030-3	30" x 30" x 3"	
110907	EL3636-3	36" x 36" x 3"	
110910	EL3842-3	38" x 42" x 3"	
151113	EL3648-3	36" x 48" x 3"	
156001	EL2436-3	24" x 36" x 3"	
156006	EL3232-3	32" x 32" x 3"	
173859	EL4040-3	40" x 40" x 3"	

3" UltraLite™ Equipment Pad

- Concrete equipment pad

Part #	Mfg #	Size	Price
156007	UL1636-3	16" x 36" x 3"	

Heat Pump Pad™

- Raises the pump a full 8" off the ground
- Precision molded from eco-friendly, recycled polypropylene
- Includes (8) high quality anti-vibration pads
- Base angled to direct melting snow or water from the unit

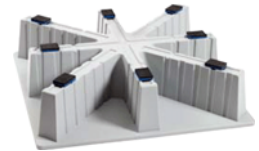

Part #	Mfg #	Size	Price
131414	HP3636-8	36" x 36" x 8"	

A/C Condenser Mounting Brackets

- No hardware included
- Pre-punched holes for fastening unit to bracket
- 7/16" Holes for wall mounting hardware
- Load capacity dependent upon hardware/wall load limitations
- 3" Bracket width, 16" height



Part #	Mfg #	Description	Price
132370	ACB-30	30" Steel, Pair	
132372	ACB-36	36" Steel, Pair	
132373	ACB-42	42" Steel, Pair	
132374	ACB-48	48" Steel, Pair	



Condenser Pads

A/C Brackets

Part #	Description	Price
042910	36" Wall Bracket	
042911	42" Wall Bracket	

Condenser Pads

Air Conditioning Hanging Brackets

- 1/8" Thick steel
- Mounts at any height



Part #	Mfg #	Description	Price
066780	19881	42" A/C Bracket	

Equipment Stands & Mounting Blocks

Pump-Up® Equipment Stand

- Elevate heat pumps and air handling units
- Corrosion-resistant plastic
- Helps prevent corrosion of metal base
- Solid 6" x 6" mounting base
- Top diameter: 4-1/8"

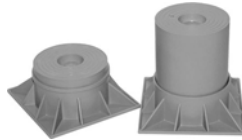

Part #	Mfg #	Description	Price
064183	4004	4" Pump-Up® Extension	
064182	4008	6" High	
056395	4012	10" High	

Sensing Bulbs

Commercial Remote Bulb Temperature Controls

T675 Remote Bulb Temperature Control

- *SPDT Switching*
- *External set point knob*
- *Set point temperature range: 0° to 100°F*
- *Maximum temperature: 125°F*
- *Differential temperature: 3° to 10°F*



Part #	Mfg #	Description	Price
006797	T675A1565	20' Copper Element	

Defrost Controls

Commercial Refrigeration Defrost Controls

8040 Series Defrost Control

- Time initiated
- Time terminated
- 40 Amp
- Adjusted length of defrost 4 to 110 minutes



Part #	Mfg #	Volts @ 60Hz	Contacts 2-4 / 1-3 / 3-N	Price
149813	8041-00	120V	Closed/Open/Closed	
149808	8041-20	208/240V	Closed/Open/Closed	

Defrost Controls

Commercial Refrigeration Controls

Single Function Pressure Control

- NEMA 1 Enclosure with non-conductive cover
- Front-located captive cover screw
- Super Cap® capillary protection system
- Universal mounting & compact design
- Laser-welded bellows for extended life

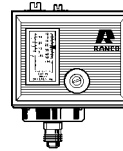

1/4" Male Flare



Part #	Mfg #	Description	Switch	Range	Differential	Price
149810	O10-1483	36" Capillary with Flare Nut	SPST Open Low	10 - 100 psig	10 - 40 psi	
063790	O10-2054	36" Capillary with Flare Nut	SPST Open Low	100 - 400 psig	40 - 150 psi	

Dual Function Pressure Control

- Exclusive "convertible" reset for manual or automatic high pressure reset on some models
- NEMA 1 Enclosure with non-conductive cover
- Front-located captive cover screw
- Super Cap® capillary protection system
- Universal mounting & compact design
- Laser-welded bellows for extended life
- Heavy-duty plated steel frame

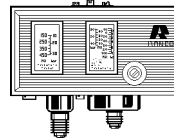

1/4" Male Flare



Part #	Mfg #	Cut-In Range PSIG	Diff. PSI	Cut-Out Range PSIG	Diff. PSI	Low Pressure (Opens Low)	High Pressure (Opens High)	Price
149809	O12-4834	10 - 100	10 - 40	150 - 450	70 Fixed	Automatic	Convertible	

Temperature Controls

ETC Commercial Temperature Control

- Wide temperature range: -30° to 220°F
- Wide differential adjustment: 1° to 30°F
- LCD Read-out for sensor temperature, control settings and relay status
- High amp output relay
- EEPROM Memory retains control settings during power outages
- Keypad lockout to prevent end-user alteration of settings
- Easy 4-step set up
- Heavy-duty relay 1 hp rated



Part #	Mfg #	Number Stages	Enclosure	Input Voltage	0 to 10 Volt Output	Price
066936	ETC-111000	1	NEMA-1	120/208/240VAC	No	
107652	ETC-112000	1	NEMA 1	24VAC	No	
064236	ETC-212000	2	NEMA 1	24VAC	No	

Cooling - Accessories

Defrost Controls

General Range Temperature Control

- Maximum adjustment accuracy with 7 revolution range adjustment screws
- NEMA 1 enclosure with non-conductive cover
- Front-located captive cover screw
- Universal mounting & compact design
- Laser-welded bellows for extended life



General Range Temperature Control - SPST - Opens High or Low

Part #	Mfg #	Applications	Range	Differential	Description	Price
149812	O10-1072	Low (Freezer)	-15° - 40°F	*+3° - 20°F	Air Coil	
149811	O10-1802	High	25° - 75°F	*+3° - 20°F	Air Coil	

*+Differential at the low end of range is 6 to 25.

Defrost Controls

Defrost Controls
Defrost Control Board

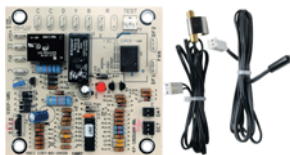

Part #	Mfg #	Description	Price
123566	47-102684-83	Defrost Control Board	
182513	47-102685-87	Defrost Control Board Kit	
032874	47-21776-86	24V Defrost Control Time/Temp	

Electrical

Contactors

Economy DP-Series Contactor

- Electro magnetically-operated definite purpose 2-pole contactors provide switching for across-the-line starting of induction motors
- Double 1/4" quick connects
- Low profile design allows for more wiring room
- Multiple mounting holes and slots for convenient, interchangeable mounting with most competitive devices
- Not ARI-780 compliant, use where a "ruggedized" device is NOT required



Part #	Mfg #	Coil Ratings Voltage	Poles	Electrical Contacts Full Load	Electrical Contacts Resistive	Price
169827	DP2030A1004	24V	2-Pole	30A @ 240/277VAC	48A @ 240/277,480,600VAC	

* #10 Combination head screws

Electrical

**Protech Contactors
Single Pole Contactor**



Part #	Mfg #	Amps	Coil Volts	FLA @230V	LRA @230V	Resistive @230V	Price
018074	42-25101-01	30A	24V	25	150	35	
030033	42-25101-03	40A	24V	40	240	50	

Two Pole Contactor



Part #	Mfg #	Amps	Coil Volts	FLA @230V	LRA @230V	Resistive @230V	Price
022556	42-25102-01	30A	24V	32	180	40	
069435	42-42139-13	40A	24V	40	240	50	

Three Pole Contactor



Part #	Mfg #	Amps	Coil Volts	FLA @230V	LRA @230V	Resistive @230V	Price
017913	42-25103-01	30A	24V	32	180	40	
053005	42-25103-02	30A	240V	32	180	40	
022561	42-25103-05	50A	24V	50	300	63	

Cooling - Accessories

Electrical

Pressure Controls

P70 Series - Single Pole High Pressure Control

- Full adjustability, minimum differential
- Long life contact structure, no bounce on make
- Manual reset models are "trip-free"
- Includes a universal mounting bracket
- For use with:
 - Air conditioning and refrigeration
 - Controls of air, water, and oil pressure



Models for High Pressure Non-Corrosive Refrigerants: R-12, R-22, R134A, R-500, R-502 (R)

Part #	Mfg #	Switch Action	Range PSIG	Diff PSI	Max Over-Pressure PSIG	Limited Knob Adj	Pressure Connection	Price
143982	P70AA-400	SPST Opens Low	100 to 470	35 to 200	690	None	36" Cap, 1/4" Flr Nut	

Electrical

LiquidTite Flex Conduit and Fittings

DiversiWhip - Metallic Connectors

- Liquid-tight flexible conduit system
- Three distinct wire colors
- (1) Straight and (1) 90° metallic connectors
- UL & cUL Listed



Part #	Mfg #	Description	Price
011632	6-12-4	1/2" x 4', #10 THHN	
011633	6-12-6	1/2" x 6', #10 THHN	
034348	6-34-6	3/4" x 6', #8 THHN	



Electrical

Electrical Parts & Accessories

RXAD - Low Ambient Control Kit

Part #	Mfg #	Description	Price
124470	RXAD-A08	Installed in Units to be Operated for Cooling at Outdoor Ambient Temperatures Under 70° F	

Low Ambient Control

Part #	Mfg #	Description	Price
108140	47-ICM325HNC	Low Ambient Fan	

Crankcase Heater

Part #	Mfg #	Description	Price
043854	44-17402-17	Crankcase Heater	
033123	44-17402-47	Crankcase Heater	

Hard Start Kit

Part #	Mfg #	Description	Price
141497	42-ICM860	Hard Start Kit	

Kick Start

- For single phase 208V, 230V, 265V A/C refrigeration and heat pump compressors
- 2-Wire pre-assembled starting component utilizes a mechanical potential relay and a start capacitor

Part #	Mfg #	Description	Price
104511	42-KS1	3-1/2 - 5 Ton Condenser Motor Kick Start	
104510	42-TO5	1 - 3 Ton Condenser Kick Start	

Electrical

Solenoid Valves

General Purpose (GP) Type I Two-Way Solenoid Valve

- *Minimum operating pressure differential: 1 psi*
- *Maximum temperature: 225°F*
- *Normally closed only*
- *For general application on non-corrosive fluids such as air, water below 180°F, light oils below 300 SSU and low vacuum*



Part #	Mfg #	Description	Price
005716	70562	1/2" Port, 1/2" FPT	
005717	70712	3/4" Port, 3/4" FPT	

Solenoid Coils for GP Valve

Part #	Mfg #	Description	Price
005722	77300	9W, 24V, 50/60Hz	
005720	77310	9W, 120V, 56/60Hz	
005719	77360	9W, 120/240V, 50/60Hz	

Solenoid Valve Repair Kit

Part #	Mfg #	Description	Price
005723	76731	Valve Repair Kit for GP600 (70712)	

Crankcase Heaters

Crankcase Heaters

Belly Band Type - Scroll Compressor

- Easy to install; adjustable by screw
- Uses high temperature silicone rubber element
- For optimum heat transfer, mount in lowest position on compressor housing

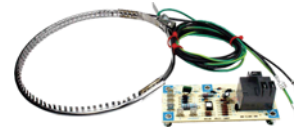

Part #	Mfg #	Volts	Watts	Lead Wire Size (AWG)	Lead Wire Length	Ground Wire Length	Price
137561	44-101884-05	230V	40W	18	48"	48"	
091893	44-17402-44	230V	40W	18	48"	22"	
009323	44-17402-45	230V	40W	18	48"	48"	

Filter Driers

Liquid Line Filter-Driers

Liquid Line Filter-Drier (Uni-Directional)

- Solid core, activated alumina with molecular sieve
- Corrosion resistant epoxy powder paint finish
- Suitable for R-22 and R-410A
- 680 psig Maximum working pressure
- Solid copper fittings



Part #	Mfg #	Connection	OAL	Body Length	Body Diameter	Price
179891	83-25151-41	3/8" Sweat ODF	5-5/16"	3-7/8"	2-5/8"	
180298	83-25151-42	3/8" Sweat ODF	6-1/8"	4-5/8"	2-5/8"	

Liquid Line Filter-Drier (Bi-Directional)

- Solid core, activated alumina with molecular sieve
- Internal check valve for heat pump applications
- Removes all types of foreign particulate material
- Corrosion resistant epoxy powder paint finish
- For R-22 and R-410A, 680 psig maximum working pressure
- Solid copper fittings



Part #	Mfg #	Connection	OAL	Body Length	Body Diameter	Price
180774	83-25152-10	3/8" Sweat ODF	6-1/8"	4-5/8"	3-1/8"	
096137	83-EK-163S	3/8" Sweat ODF	6-1/4"	4-3/4"	2-5/8"	

ADK Core Style Liquid Line Filter-Drier (Uni-Directional)

- Corrosion resistant epoxy powder paint finish
- High moisture and acid removal capacity
- Solid copper ODF fittings
- Copeland approved for POE oils
- 40 Micron filtration
- UL/cUL File SA3124



Part #	Mfg #	Connection	OAL	Body Length	Body Diameter	Price
149928	83-ADK-052	1/4" Flare SAE	4-13/16"	3"	2-5/8"	
149929	83-ADK-053	3/8" Flare SAE	5-1/8"	3"	2-5/8"	
133408	83-ADK-083	3/8" Flare SAE	5-15/16"	3-3/16"	2-5/8"	
149930	83-ADK-084	1/2" Flare SAE	6-3/16"	3-3/16"	2-5/8"	
094060	83-ADK-162	1/2" Flare SAE	6-7/16"	4-5/8"	2-5/8"	
149932	83-ADK-163	3/8" Flare SAE	6-3/4"	4-5/8"	2-5/8"	
149933	83-ADK-164	1/2" Flare SAE	6-15/16"	4-5/8"	2-5/8"	
149934	83-ADK-165	5/8" Flare SAE	7-7/16"	4-5/8"	2-5/8"	
149935	83-ADK-303	3/8" Flare SAE	9-5/8"	7-1/2"	3-1/16"	
149936	83-ADK-304	1/2" Flare SAE	9-7/8"	7-1/2"	3-1/16"	

Cooling - Accessories

Filter Driers

Sporlan Catch-All Liquid Line Filter-Drier (Uni-Directional)

- Solid core, activated alumina with molecular sieve
- Corrosion resistant epoxy powder paint finish
- Suitable for R-22, R-410A
- 650 psig Maximum working pressure

Part #	Mfg #	Connection	OAL	Body Length	Body Diameter	Price
097691	83-25208-01	1/4" Sweat ODF	4-3/16"	3-7/16"	2-7/16"	
080952	83-25208-03	3/8" Sweat ODF	5-1/4"	4-3/8"	2-5/8"	
080950	83-25208-04	3/8" Sweat ODF	5-7/8"	5"	3"	
080951	83-25208-05	1/2" Sweat ODF	6"	5"	3"	

Suction Line Filter-Driers

Suction Line Filter Drier (Standard Shell)

- Solid core; solid copper fittings
- Activated alumina/activated carbon/molecular sieve desiccant
- Suitable for R-22 and R-410A, 500 psig maximum working pressure
- For use after a burnout or when major system work has been performed
- (2) Pressure taps; one each at the inlet and outlet ends
- Corrosion resistant epoxy powder paint finish



83-25153-10

Part #	Mfg #	Connection	OAL	Body Length	Body Diameter	Price
087301	83-25153-10	3/4" Sweat ODF	9-5/8"	7-7/16"	3"	
096158	83-25153-11	7/8" Sweat ODF	9-7/16"	7-7/16"	3"	

Sporlan Catch-All Suction Line Filter-Drier (Standard Shell)

- Solid core, solid copper fittings
- Premium product with activated alumina/activated carbon/molecular sieve desiccant
- Suitable for R-22, R-410A
- 650 psig Maximum working pressure
- For use after burnout or when major system work has been performed
- One pressure tap at the inlet end
- Corrosion resistant epoxy powder paint finish



Part #	Mfg #	Connection	OAL	Body Length	Body Diameter	Price
092126	83-25209-03	7/8" Sweat ODF	6-5/16"	4-9/16"	3"	
087302	83-25209-05	7/8" Sweat ODF	9-3/4"	8"	3"	
092125	83-25209-06	1-1/8" Sweat ODF	9-3/4"	8"	3"	

Cooling - Accessories

Filter Driers

CSFD Suction Line Filter-Drier (Compact Shell)

- Solid core; solid copper fittings
- Activated alumina with molecular sieve desiccant
- Suitable for R-22 and R-410A
- Maximum working pressure: 400 psig
- Compact design for short lay-in applications
- Two pressure taps; one each at the inlet and outlet ends
- Corrosion resistant epoxy powder paint finish



Part #	Mfg #	Connection	OAL	Body Length	Body Diameter	Price
149938	83-CSFD-14S4VV	1/2" Sweat ODF	4-1/4"	2-3/4"	4-5/8"	
149939	83-CSFD-14S5VV	5/8" Sweat ODF	4-1/2"	2-3/4"	4-5/8"	
140741	83-CSFD-14S6VV	3/4" Sweat ODF	4-3/8"	2-3/4"	4-5/8"	
140742	83-CSFD-14S7VV	7/8" Sweat ODF	4-9/16"	2-3/4"	4-5/8"	

Filter Driers

Filter-Driers

Liquid Line Filter-Drier

- One valve can be employed for all refrigerants
- Maintains constant evap pressure
- Provides freeze-up protection on A/C
- Compatible with all existing and new refrigerants
- High moisture capacity dessicant



Part #	Mfg #	Size	Connection	Price
008288	SS-052S	1/4"	Sweat	
008290	SS-083S	3/8"	Sweat	

Suction Line Filter-Drier

- 500 Hours salt spray protection
- High capacity acid retention desiccants
- Solid copper sweat fittings



Part #	Mfg #	Size	Connection	Price
008255	SLD135SV	5/8"	Sweat	
008257	SLD277SV	7/8"	Sweat	



Filter Driers

Condenser Accessories

Filter Drier

Part #	Mfg #	Description	Price
092127	832520902	Filter-Drier 3/4" C166sth	

Leak Detection

Leak Detectors

Leak-Tech Gold™

- For use on gas lines, gas cylinders, refrigeration condensers, air lines ,air pumps or any other system carrying gas
- Can be used on all types of piping
- Non-toxic and non-corrosive
- Temperature range: 28° to 180°F
- Not for use on oxygen systems

Part #	Mfg #	Description	Price
034246	LT08	8 oz with Dauber	
034245	LS16	1 pt Spray Bottle	

Leak Detection

Leak Detectors

Sure-Chek® All-Temperature Leak Detector

- Ultra-sensitive, long-lasting bubbles
- Fluorescent for improved visibility
- Safe for oxygen
- Non-corrosive, non-toxic



Part #	Mfg #	Size	Price
033194	32850	1 pt	

VISU-GLOW® High Visibility Leak Detector

- Fluorescent color shows brightly even in dimly lit places
- For use on CSST systems
- High viscosity stays on vertical surfaces
- Makes it easy to find leaks
- Non-corrosive, non-toxic
- Safe for oxygen
- Temperature range: 15° to 200°F



Part #	Mfg #	Size	Price
005975	32898	8 oz	



Leak Detection

Leak Detectors

Megabubble® Leak Detector

- Detects gas leaks in pipe lines, tanks, coils, cylinders, valves, etc
- Used to detect leaks of air, natural gas, refrigerants, CO2 and almost all known gases
- Non-toxic and contains only high quality, non-staining ingredients



Part #	Mfg #	Size	Price
132929	45801	8 oz Dauber Bottle	

Leak Detection

All-Purpose Leak Detectors

- *Detects leaks quickly on all types of tubing valves, cylinders, pressure tanks or other systems under air, gas or oxygen pressure*
- *Temperature range: -55 to +160°F*
- *Slow evaporation rate provides longer inspection time*



Part #	Mfg #	Size	Price
018413	30209	8 oz with Dauber	
031651	30212	1 gal	

Leak Detection

Leak Detectors

Tracker System Replacement Dye

- Universal A/C Dye
- Use with mineral, ester and alkylbenzene oils
- Shines bright yellow in UV light



Part #	Mfg #	Size	Dye	Case Qty	Price
034252	16276	1/4 oz	R-12	12	

Leak Detection

Leak Detectors

Big Blu Micro Leak Detector Solution

- *The only bubble detector capable of identifying gas leakage approaching the sensitivity of electronic sniffers*
- *Non-toxic*
- *Biodegradable*
- *Oxygen safe*



Part #	Mfg #	Description	Price
134238	RT100S	1 qt Spray	

Super Blu Micro Leak Detector Solution

- *50% Glycol solution at the same level of Big Blu detector*



Part #	Mfg #	Description	Price
135048	RT150S	1 qt Spray	

Leak Detection

Leak Detection Flashlights

OPTIMAX Jr™ LED Leak Detection Flashlight

- Cordless
- Blue light LED for leak detection
- Perfect for tight spaces
- Power comparable to high intensity 75W lamps
- Inspection range up to 6' or more
- 100,000/Hour LED life
- Powered by (3) "AA" batteries (included)
- Includes fluorescence-enhancing glasses (UVS-40)



Part #	Mfg #	Description	Price
138625	OPX-500CS	OPTIMAX Jr™ Flashlight	

Dual-Max™ Multi-Function LED Flashlight

- Cordless
- Dual-head flashlight features super bright blue light LED for leak detection plus white light LED for general component inspection
- Power comparable to high intensity 75W lamps
- Inspection range up to 6' or more
- Compact design allows easy access into tight spaces
- 100,000/Hour LED life
- Powered by (3) "AAA" batteries (included)
- Includes holster and fluorescence-enhancing glasses (UVS-40)



Part #	Mfg #	Description	Price
138626	OPD-500CS	Dual-Max™ Flashlight	

Leak Detection Kits

GLO-STICK® Kit with OPTIMAX Jr™ Flashlight

- For small to medium size AC&R systems, including high pressure R-410A systems
- Includes:
 - OPTIMAX Jr™ flashlight (OPX-500CS)
 - (1) Bleed valve for attaching GLO-STICK® capsule to service hose (BV-50)
 - (1) Purge capsule (PC-0249)
 - (1) Hose to connect to low side service port (119567)
 - (1) Universal/POE GLO-STICK® dye capsule (GS-1/E)
 - (2) Universal/POE GLO-STICK® dye capsules (GS-2/E)
 - (1) Universal/POE GLO-STICK® dye capsule (GS-3/E)
 - Fluorescence-enhancing glasses (UVS-40)
 - 8 oz Spray bottle of GLO-AWAY™ dye cleaner (CR-800)
 - Plastic carrying case (CC-110)



Part #	Mfg #	Description	Price
138623	OPK-50GS/E	GLO-STICK® Kit w/OPTIMAX Jr™ Flashlight	

Injection Kits

ACID-BUSTER™ Injection Kit

- Acid scavenging solution, eliminates acid buildup in AC&R systems
- Prevents compressor burnout
- Ideal for small to medium sized systems
- Works with all lubricants and systems, including high pressure R-410A systems
- Includes:
 - EZ-Ject™ injector assembly (EZ-50)
 - Hose assembly complete with check valve and 1/4" flare low-loss fitting (EZ-25)
 - (2) 0.5 oz EZ-Ject™ cartridges filled with ACID-BUSTER™ acid scavenging solution (AB-5CS)



Part #	Mfg #	Description	Price
138635	AB-100CS	ACID-BUSTER™ Injection Kit	

Leak Detection

Cartridges

EZ-Ject™ Universal Dye Cartridge

- (6) 0.5 oz Dye cartridges for mineral oil, polyolester and alkyl benzene



Part #	Mfg #	Description	Price
138624	EZ-4/ECS	Treats up to 25 lbs of Refrigerant or 2 gals of Lubricant	

Replacement ACID-BUSTER™ Universal Cartridge

- Filled with ACID-BUSTER™ acid scavenging solution



Part #	Mfg #	Description	Price
138636	AB-5CS	0.5 oz Cartridge for EZ-Ject™	

GLO-STICK® Universal Dye Capsules

- For small to medium size systems
- Prefilled, disposable capsules allow dye to be injected into pressurized systems using refrigerant
- Will withstand pressures of more than 1000 psi
- For mineral oil, polyester and alkyl benzene lubricant systems



Part #	Mfg #	Description	Price
138629	GS-101/ECS	Case of (6) 0.03 oz Capsules, Up to 2.9 lbs of Refrigerant or 15 fl oz of Lubricant	
138630	GS-1/ECS	Case of (6) 0.5 oz Capsules, Up to 4.9 lbs of Refrigerant or 1.6 qts of Lubricant	
138632	GS-2/ECS	Case of (6) 0.5 oz Capsules, 5 to 9.9 lbs of Refrigerant or 1.7 to 3.2 qts of Lubricant	
138634	GS-3/ECS	Case of (6) 0.5 oz Capsules, 10 to 25 lbs of Refrigerant or 3.3 qts to 2 gals of Lubricant	

Cooling - Accessories

SpeediChannel Line Set Cover Systems

SpeediChannel™ Line Set Covers

- SpeediChannel™ 6-1/2' long and can be cut-to-size
- UV-Resistant, UL listed
- White finish, paintable



Mini-Split Drain Line

- Cut marks every 3.28'



Part #	Mfg #	Size	Price
140145	230-DL16	5/8" ID x 160'	
140146	230-DL20	3/4" ID x 160'	

Part #	Mfg #	Size	Description	Price
113862	230-B2M	18"	Type 2 Wall Bracket (Med)	
113863	230-B2L	21"	Type 2 Wall Bracket (Lg)	
113138	230-D3	3"	Channel	
113145	230-D4	4"	Channel	
113139	230-CP3	3"	Union Coupling	
113146	230-CP4	4"	Union Coupling	
117848	230-TC34	3" x 4"	Reducer Coupling	
117851	230-DC3	3"	Cap	
113141	230-DE3	3"	End Cap	
113148	230-DE4	4"	End Cap	
117841	230-EB3	3"	90° Inside Elbow	
117843	230-EIN3	3"	90° Outside Elbow	
113140	230-FB3	3"	90° Flat Elbow	
117846	230-FB454	4"	45° Flat Elbow	
117842	230-EB4	4"	90° Inside Elbow	
117844	230-EIN4	4"	90° Outside Elbow	
113147	230-FB4	4"	90° Flat Elbow	
117840	230-LFB4	4"	90° Long Radius Flat Elbow	
117839	230-LFB3	3"	90° Long Radius Flat Elbow	
113142	230-WC3	3"	Wall Penetration Sleeve	
113149	230-WC4	4"	Wall Penetration Sleeve	
117850	230-FJ4	4"	Flex Joint	
117849	230-FJ3	3"	Flex Joint	
117847	230-TJ4	4"	T-Joint	
116968	230-MB17W	17"	Mounting Block White	
116969	230-MBCW		Mounting Block End Cap	
117853	230-FR3	3"	Wall Escutcheon	

Refrigerant Parts & Accessories

Thermo-Snap Clamps™

Universal Mounting Bracket

- *Pre-mounted brackets provide an easy one-man installation job*
- *Multi-use applications including copper, PVC and ABS pipe*
- *Maintenance free - use indoors or out*
- *Eliminates vibrations and noise call backs*
- *Easy to re-open for an additional or custom adjustment*
- *UV Protected*



Part #	Mfg #	Description	Price
034839	41118	Residential 1-1/2" OD	
094315	41125	Commercial Plastic Line 2" OD	

Mounting Systems

Mounting Brackets and Blocks

Quick-Swivel Flush Mount with H Bracket

- The flush mount hanger is slotted to receive a 3/8 lag bolt 16" or 24" on center. It can be attached parallel or perpendicular to the joist
- Our Quick Swivel is made with 14-gauge steel able to hold 200 lbs
- The swivel allows for 360 degree rotation for setting the perfect direction of air flow
- The square steel tubing cuts down on vibration while 3 hitch-pins add to the safety and sturdiness of the Quick Swivel with "H" bracket
- All necessary hardware for installation provided



Part #	Mfg #	Description	Price
175023	QSWI3000	Holds up to 200lbs, H Bracket with Non-Swinging Rotating Platform	

Mini Split Stand

- 12" High
- The Mini-Split Stands provide a safe, stable platform for mounting a wide variety of HVAC/R equipment
- Keeps unit elevated above lawn mowers, weed trimmers, pets, snow and flooding



Part #	Mfg #	Description	Price
175026	QSMS1201	Holds up to 400lbs, 12" High - Wide	
175025	QSMS1200	Holds up to 400lbs, 12" High - Thin	

Novent Locking Caps

Refrigerant Parts & Accessories

Refrigerant Caps and Accessories



R22 Cap



R410 Cap



Multikey



Part #	Mfg #	Description	Price
139299	NG-R22-2PK	Tamper-Resistant Green Caps R22 2/Pack	
139303	NG-R22-SDT	Screwdriver/Key R22 Green/Silver	
139300	NG-R410-10PK	Tamper-Resistant Pink Caps R410 10 Pack	
139304	NG-R410-SDT	Screwdriver/Key R410 Pink	
139302	NV-MULTI-KEY	Locking Refrigerant Cap Key	

Refrigeration Ball Valves with Press Port

**Refrigerant Ball Valves
ABV Refrigeration Ball Valve**

- Forged brass body, hermetic design with access valve



Part #	Mfg #	Connection Size	OAL	Description	Price
181357	BVS-038	3/8" ODF	5-1/2"	1/2" SAE Port with Schrader Core	
181358	BVS-012	1/2" ODF	6-3/8"	1/2" SAE Port with Schrader Core	
181130	BVS-078	7/8" ODF	7-1/2"	3/4" SAE Port with Schrader Core	
181359	BVS-138	1-3/8" ODF	10"	1-1/4" SAE Port with Schrader Core	

Site Glasses

Sight Glasses
Ruud™ Sight Glass



Part #	Mfg #	Connection	OAL	Price
140739	83-25156-02	3/8" Sweat ODF	4-5/8"	
140740	83-25156-04	1/2" Sweat ODF	4-7/8"	

See-All Sight Glass - Sporlan

- Painted steel body with copper fittings
- Includes protective cap for glass viewing window
- Suitable for R-22 and R-410A, 650 psig maximum working pressure



Part #	Mfg #	Connection	OAL	Price
022555	83-25211-02	3/8" Sweat ODF	4-5/8"	
022563	83-25211-04	1/2" Sweat ODF	4-7/8"	



Site Glasses

Ruud Sight Glasses RXAG - Sight Glass Kit

Part #	Mfg #	Description	Price
094285	RXAG-A048	For 125,150,151 Comm Condensing Units & 75,100 Heat Pumps	



Tap Valves & Piercing Valves

Valves

Piercing Valve

Part #	Mfg #	Description	Price
085911	611002	QTM2 Line Piercing Valve	
133637	4051-99	A/C Piercing Valve & Hose	

Valve

Part #	Mfg #	Description	Price
104504	83-CD4338-1PK	Line Tap Valve	

Cooling - Accessories

Aluminum Faced Board Panning & Grille Frames

Ducts, Fittings & Accessories

ThermO-Pan®

ThermO-Pan™ with Connectors

- ThermO-Pan® is a high quality, lightweight alternative to sheet metal in constructing return air ducts between joists
- Consists of corrugated insulation faced with aluminum
- Available in light weight sheets in many sizes
- Significantly reduces duct noises and labor
- Requires no shop fabrication
- Molded polypropylene ThermO connectors which easily connect ThermO-Pan® panels
- Kit includes panning, connectors, and (4) headers

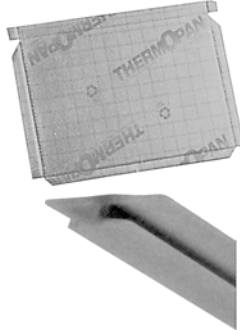

Part #	Mfg #	Size	Price
034604	16049	16" x 47-1/2" Kit	
034602	19049	19-1/2" x 47-1/2"	
034603	24049	24" x 47-1/2"	
034605	32037	32" x 35-1/2"	

ThermO-Headers™

- For tight sealing air block
- ThermO-Headers™ are pre-cut and scored to fit easily between joists
- Specially-sized headers are cut and scored to fit I-joist construction

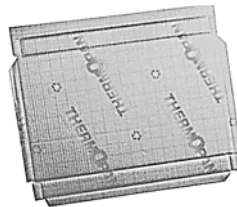

ThermO-Header Class 1 Fire Rated

Part #	Mfg #	Size	Description	Price
121097	16018	16" x 18"	I-Joist Header	
129601	16020	16" x 20"	I-Joist Header	

ThermO-Frames™

Standard Return Air Grille Dry Wall Frame

- Precision molded polypropylene
- Safety edged
- Frames can be cut for use as a single frame
- Place grille over frame and screw into precision molded frame holes on finished dry wall
- Allows unfiltered air flow



Part #	Mfg #	Size	Price
026507	14630	30" x 6", or 2 @ 14" x 6"	

Canvas Duct Connectors

Flexible Duct Connectors

Metal-Fab Connector

- 3" Metal, 3" fabric, 3" metal
- 24 Gauge galvanized
- Grip Loc seam
- 100' Roll



Part #	Item #	Item #	Description	Price
036577	10159	MBX333	Black Excelon®	

Junior Connector

- 1-3/4" Metal, 3" fabric, 1-3/4" metal
- 28 Gauge galvanized
- Guard Loc seam
- 100' Roll



Part #	Item #	Item #	Description	Price
005603	10169	JBX-100	Black Excelon®	



Duct Boosters

Duct Boosters®

- Fits round or flat forced air heating/cooling ductwork
- Boosts air flow up to 275 CFM



Part #	Mfg #	Description	Price
010372	DB-2	Original 120V, 1/20 hp, .51A - 6" & 8" Duct	

Duct Fans

- Fans can be used for exhaust or fresh air intake applications
- Fits metal or flex duct
- Capacities from 180 CFM up to 1,200 CFM



Part #	Mfg #	Description	Price
061571	EF-6	For 6" 120V, 30W, .40A	
023837	EF-8	For 8" 120V, 56W, 1.1A	

Duct Boosters

Air Boosters

Air Booster

- *Installs in branch duct of any room*
- *Adds up to 1,150 CFM to needy rooms*
- *Can be wired electrically through the main blower, a wall switch, or a line voltage thermostat in the room*



Part #	Mfg #	Size	Price
116050	84-25253-01	6"	

Ducts, Fittings & Accessories

Duct Tape

Ducts, Fittings & Accessories

Duct Tape

221 Solvent Resistant Duct Tape

- Rubber based adhesive
- Polyethylene coated cloth backing
- Crisp, straight tear and smooth unwind



Part #	Mfg #	Size	Color	Price
010344	221	2" x 60 yds	White	

227 Contractor Grade Duct Tape

- Bonds to all types of surfaces
- Will not twist or curl



Part #	Mfg #	Size	Color	Price
010345	227	2" x 60 yds	Silver	

398 Professional Grade Duct Tape

- 011 mil Thickness
- Excellent balance of tearability and tensile strength; 27 lbs/inch
- Conforms well to irregular surfaces
- Superior holding power for hanging applications
- Tears straight, hangs straight, curl resistant
- Easy unwind
- Low VOC content
- PE-coated cloth backing with rubber adhesive



Part #	Mfg #	Size	Color	Price
077358	398B	2" x 60 yds	Black	

338 FSK Insulation Tape

- Kraft Paper
- Synthetic rubber Adhesive
- Foil/Tri-Directional Fiberglas/Paper
- Aluminum



Part #	Mfg #	Size	Color	Price
176968	338	3" x 50 yds	Aluminum	

Duct Tape

Gaffer's Tape

- Premium vinyl coated
- Low gloss, non-reflective cloth backing



Part #	Mfg #	Size	Color	Price
010351	510	2" x 60 yds	Gray	

Foil Tape

337 Premium Foil Tape

- UL 723 Listed
- 3.7 mil Thickness
- Tensile strength: 14 lb/in
- Exceptional quick stick
- Dead-soft aluminum foil backing for rigid preformed aluminum foil-faced duct systems
- Synthetic rubber adhesive
- Low VOC



Part #	Mfg #	Size	Price
010349	337	2" x 50 yds	
010350	337	3" x 50 yds	

339 Cold Weather Premium UL 181A and B Printed Foil Tape

- 4.8 mil Thickness
- Tensile strength: 23 lb/in
- High performance in both cold and hot weather
- Instant adhesion, superior quick stick
- Premium performance in joining and sealing rigid fiberglass duct board and Class 1 flex duct
- Tear resistant
- Low VOC



Part #	Mfg #	Size	Price
124231	339	2-1/2" x 60 yds	
124230	339	3" x 60 yds	

360-17 Waterproofing Repair Tape

- For indoor or outdoor sealing of medium and high pressure HVAC duct systems including metal duct, fiberglass duct, flex duct
- Seals cracks and seams in gutters, roof alleys, eaves, hips and ridges
- Seals around chimneys and vent stacks
- Repair gouges, rips, tears in metal panels
- Foilmastic permanent sealant tape - heavy-duty
- Acceptable for use on galvanized materials
- Provides instant water-tight bond
- Paintable - use in place of caulking
- Excellent resistance to cold, heat, water and sunlight



Part #	Mfg #	Size	Price
038561	360-17	3" x 100'	

Ducts, Fittings & Accessories



Duct Accessories

PVC Tape

PVC Tape for Fiberglass

Part #	Mfg #	Size	Price
044361	3043033	2" x 100'	

Ducts, Fittings & Accessories

Duct Fasteners

Rivets

Stainless Rivet



Part #	Mfg #	Rivet Dia	Body Length	Mandrel	Pk Qty	Price
006487	SS/SS42DT	1/8"	.232	Stainless	1,000	
006488	SS/SS44DT	1/8"	.357	Stainless	1,000	

Steel Rivet



Part #	Mfg #	Rivet Dia	Body Length	Mandrel	Pk Qty	Price
006491	SS42DT	1/8"	.232	Plated	1,000	
006490	SS42DX	1/8"	.232	Plated	100	
006492	SS44DX	1/8"	.357	Plated	100	

Screws

Zip-In® Screw

Zip-in®



Part #	Mfg #	Size	Pkg Qty	Price
006427	HW7x1/2Z	7 x 1/2"	15,000	
006428	HW7x1/2ZT	7 x 1/2"	1,000	
006426	HW7x1/2ZX	7 x 1/2"	100	
006434	HW8x1/2ZT	8 x 1/2"	1,000	
006433	HW8x1/2ZX	8 x 1/2"	100	
006436	HW8x3/4ZT	8 x 3/4"	1,000	
006435	HW8x3/4ZX	8 x 3/4"	100	
092077	HW8x1Z	8 x 1"	7,000	
026305	HW8x1ZT	8 x 1"	500	
006429	HW8x1ZX	8 x 1"	100	
006431	HW8x11/2ZT	8 x 1-1/2"	250	
006430	HW8x11/2ZX	8 x 1-1/2"	50	
046929	HW8x2ZT	8 x 2"	250	
006419	HW10x1ZX	10 x 1"	100	

Zip-In® White Screw

Zip-in®

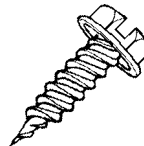

Part #	Mfg #	Size	Pkg Qty	Price
066164	HW8X2ZWT	8 x 2"	250	

Drill-In Screw



Part #	Mfg #	Size	Pkg Qty	Price
084193	HW10X2T	10 x 2"	250	

Screws (Continued)

Drill-In Screw

Part #	Mfg #	Size	Pkg Qty	Price
006424	HW10X2X	10 x 2"	50	

Bit-Tip® #2 Screw - Hex Washer Head

- Taps a matching thread
- Drills it's own hole
- Fastens in steel up to .200 thick

Bit-Tip®



Part #	Mfg #	Screw Size	Driver Size	Pkg Qty	Price
037082	BT131	8-18 x 1/2"	1/4"	100	
037085	BT133T	8-18 x 3/4"	1/4"	500	
037083	BT133	8-18 x 3/4"	1/4"	100	



Duct Fasteners

Connector Systems

Ductmate 35 Rectangular Flange System

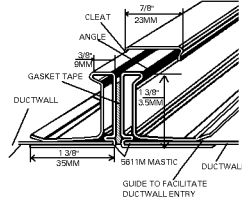

Part #	Mfg #	Description	Price
005621	DM35	DM35™ Flange System	

Ductmate 35 Corner



Part #	Mfg #	Description	Price
005615	DC111B	35 Corner with Clips	

Ducts, Fittings & Accessories

Duct Fasteners

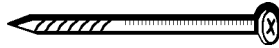
Duct Fasteners**PN Spotter Pin**

Part #	Mfg #	Size	Pack	Price
072531	26001	3/4"	1000	

Duct Fasteners

Duct Adhesives

Iron-Grip™ 601

- For use on metal duct, glass fiber duct board, flex duct, duct fabric and flexible tubing runouts
- Indoor/outdoor use
- Water-based
- All pressure classes
- UL Classified



Part #	Mfg #	Size	Price
022827	304135	1 gal	

Duct Fasteners

Mastic Duct Sealants

Versa-Grip™ 181

- For use on metal duct, glass fiber duct board and flexible duct
- Indoor/outdoor use
- Water-based
- All pressure classes
- UL 181A-M/181B-M Listed



Part #	Mfg #	Size	Color	Price
124963	304138	1 gal	White	

Duct-Seal™ 321

- Indoor/outdoor use
- Water-based
- All pressure classes
- UL Classified



Part #	Mfg #	Size	Color	Price
125162	304156	1 gal	Gray	

Iron-Grip™ 601

- For use on metal duct, glass fiber duct board, flex duct, duct fabric and flexible tubing run outs
- Indoor/outdoor use
- Water-based
- All pressure classes
- UL Classified

1 Gallon



Part #	Mfg #	Size	Price
124961	304137	11 oz	

Duct Liner Adhesives

Coil-Tack™

- Formerly Glas-Grip 901
- Low tack, nonflammable, water-based insulation adhesive engineered for spray or extruding coil line applications
- Low-viscosity liquid
- Synthetic latex



Part #	Mfg #	Size	Color	Price
128234	308584	50 gal	Black	

Travel-Tack™

- Portable insulation adhesive spray system
- Polymer-based aerosol spray
- Excellent water resistance



Part #	Mfg #	Description	Color	Price
125163	308599	15 oz Aerosol	VOC Clear	

Damper Accessories

Kwiki Damper Regulator



Part #	Mfg #	Description	Price
125160	307963	Kwiki Damper Regulator	



Duct Hangers

Basset Brackets - Galvanized Self-Nailing Galvanized Bracket

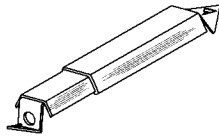

Part #	Mfg #	Description	Ctn Qty	Price
002244	A-150	12" to 19" Regular	50	
034448	E-125G	19" to 26" X-Long	25	

"Tab" Galvanized Bracket

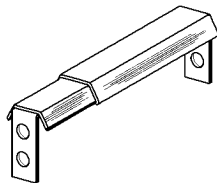

Part #	Mfg #	Description	Ctn Qty	Price
047447	AT-150	12" to 19" Regular	50	

"Tab" Galvanized Bracket with Pre-Loaded Screws

Part #	Mfg #	Description	Ctn Qty	Price
103953	AT-S150	12" to 19" Regular	50	

Pipe Hangers

- Installation of round 5" or 6" heating pipes

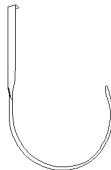

Part #	Mfg #	Carton Qty	Price
002245	BH-2	50/Box	

Square Duct Hangers - Galvanized

- 18 Gauge

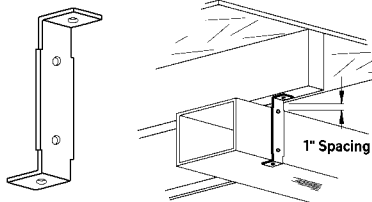

Part #	Mfg #	Size	Price
035563	BH-8	8"	
038070	BH39	9"	
125557	BH-10	10"	

Basset Straps Duct Strap



- For all square ducts running below the joists
- 18 Gauge galvanized steel

Part #	Mfg #	Qty	Price
002246	DS-3	100/Carton	

Duct Sealants

Mastic Duct Sealants

#6 Mastic Fiber Seal

- Low to high velocity air duct sealant
- Non-toxic adhesive-sealant for permanently sealing fabricated joints and seams of sheet metal air ducts, UL-181 listed rigid fiberglass air ducts, UL-181 listed flexible air ducts and thermal insulation
- Water-based and non-flammable
- High solid content
- Fiber reinforced
- Weather resistant
- Elastomeric
- City of Los Angeles Approval #RR820



Part #	Mfg #	Size	Price
121139	106001	1 gal	

Flexible Duct

Class 1 Air Connectors

F090 Commercial Series Uninsulated Duct

- UL and CUL listed
- 25' lengths
- Class 1 air connector
- High pressure, multi-ply metalized/polyester core, 16" W.C. positive, 1" negative (1/2" W.C. neg for 14" - 20" diameter)
- GREENGUARD Level 4 highly microbial resistant
- Double-ply, black polyester core, 12" W.C. positive, 1" negative (F010)



Part #	Mfg #	Size	Price
222469	HCF0903	3" x 25'	
222473	HCF0904	4" x 25'	
222475	HCFF0905	5" x 25'	
222476	HCF0906	6" x 25'	
222474	HCFF09012	12" x 25'	

Flexible Duct

Insulated Flexible Duct

Silver Flex Duct

- Metalized polyester jacket reinforced with fiberglass scrim
- Double-ply, black polyester core 12" W.C. positive, 3/4" W.C. negative
- UL-listed
- R-8.0 (F218)
- R-4.2 (F214)
- R-6.0 (F216)
- Boxed
- 25' Length
- GREENGUARD level 4 highly microbial resistant



Part#	Mfg#	Model	Size	Price
222558	051036	F214	5" x 25'	
222559	051037	F214	6" x 25'	
222560	051038	F214	7" x 25'	
222563	051041	F214	10" x 25'	
222564	051042	F214	12" x 25'	
222565	051043	F214	14" x 25'	
222566	051044	F214	16" x 25'	
222553	047308	F214	6" x 50'	
222555	047310	F214	8" x 50'	
223811	051325	F216	6" x 25'	
223813	051327	F216	8" x 25'	
224487	27825	F218	6" x 25'	
224484	27829	F218	10" x 25'	
224485	27830	F218	12" x 25'	

F114 Black Flex Duct

- Black polyethylene jacket
- R-4.2
- UL-listed
- Boxed or bagged (FB series)
- 25' and 50' lengths
- GREENGUARD Level 4 highly microbial resistant
- Double-ply, black polyester core 12" W.C. positive, 3/4" W.C. negative (1/2" W.C. neg for 14" - 20" diameter)



Part#	Mfg#	Model	Size	Price
222495	051001	F114	4" x 25'	
222496	051002	F114	5" x 25'	
223804	051003	F114	6" x 25'	
222497	051004	F114	7" x 25'	
223805	051005	F114	8" x 25'	
222498	051006	F114	9" x 25'	
222499	051007	F114	10" x 25'	

Insulated Flexible Duct (Continued)

F114 Black Flex Duct

Part#	Mfg#	Model	Size	Price
222500	051008	F114	12" x 25'	
222501	051009	F114	14" x 25'	

F104 Sleeve

- Black polyethylene jacket
- R-4.2
- One starter cone per carton



Part#	Mfg#	Model	Size	Price
222479	HCF1044	F104	4" x 5'	
222480	HCF1045	F104	5" x 5'	
222481	HCF1046	F104	6" x 5'	
222482	HCF1047	F104	7" x 5'	
222483	HCF1048	F104	8" x 5'	
222484	HCF1049	F104	9" x 5'	
222485	HCF10410	F104	10" x 5'	
222486	HCF10412	F104	12" x 5'	
222487	HCF10414	F104	14" x 5'	
222488	HCF10416	F104	16" x 5'	

F206 Silver Sleeve

- Metalized polyester jacket
- UL-classified
- R-6.0
- 5' Length
- Starter cone included in each carton



Part#	Mfg#	Model	Size	Price
222545	HCF2066	F206	6" x 5'	
222543	HCF2064	F206	4" x 5'	
222544	HCF2065	F206	5" x 5'	
222546	HCF2067	F206	7" x 5'	
222547	HCF2068	F206	8" x 5'	
222548	HCF2069	F206	9" x 5'	
222549	HCF20610	F206	10" x 5'	
222550	HCF20612	F206	12" x 5'	
222551	HCF20614	F206	14" x 5'	
222552	HCF20616	F206	16" x 5'	

Flexible Duct

Ducts, Fittings & Accessories

Insulated Flexible Duct - 30 Series

- Air-tight inner core - energy efficient, no fiberglass erosion into air stream
- Encapsulated wire helix, no unraveling when cut to length / quick installation
- Smooth inner core for low friction loss
- Thick blanket of fiberglass insulation
- Tough reinforced polyester jacket is tear and puncture resistant
- Lightweight compact carton reduces warehouse and job site handling cost
- Greenguard Indoor Air Quality Certified



R-4.2 Insulated Metallized Jacket - Class 1 Air Duct - UL181

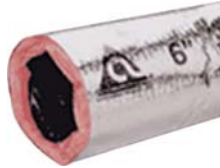

Part #	Mfg #	Size	Price
060797	030	4" x 25'	
060799	030	6" x 25'	
060800	030	7" x 25'	
060801	030	8" x 25'	
060803	030	10" x 25'	
060804	030	12" x 25'	
060805	030	14" x 25'	
060807	030	16" x 25'	

Insulated Flexible Duct - 31 Series

- Air-tight inner core - energy efficient, no fiberglass erosion into air stream
- Encapsulated wire helix, no unraveling when cut to length / quick installation
- Smooth inner core for low friction loss
- Thick blanket of fiberglass insulation
- Tough reinforced polyester jacket is tear and puncture resistant
- Lightweight compact carton reduces warehouse and job site handling cost
- Greenguard Indoor Air Quality Certified



R8 Insulated Metallized Jacket - Class 1 Air Duct - UL 181



Part #	Mfg #	Size	Price
183939	031	4" x 25'	
183940	031	5" x 25'	
183942	031	6" x 25'	
183943	031	7" x 25'	
183944	031	8" x 25'	
183945	031	9" x 25'	
183946	031	10" x 25'	
183947	031	12" x 25'	

Flexible Duct

Insulated Flexible Duct - 70 Series

- Grey polyester vapor barrier air-tight inner core - energy efficient, no fiberglass erosion into air stream
- Encapsulated wire helix, no unraveling when cut to length / quick installation
- Smooth inner core for low friction loss
- Thick blanket of fiberglass insulation
- Tough reinforced polyester jacket is tear and puncture resistant
- Lightweight compact carton reduces warehouse and job site handling cost
- Greenguard Indoor Air Quality Certified



R-4.2 Insulated Grey Jacket - Class 1 Air Duct - UL181



Part #	Mfg #	Size	Price
015419	070	4" x 25'	
015542	070	5" x 25'	
015713	070	6" x 25'	
068880	070	6" x 50'	
015762	070	7" x 25'	
015843	070	8" x 25'	
089317	070	8" x 50'	
015962	070	9" x 25'	
012325	070	10" x 25'	
013302	070	12" x 25'	
013585	070	14" x 25'	
013645	070	16" x 25'	
013698	070	18" x 25'	

R-6.0 Insulated Grey Jacket - Class 1 Air Duct - UL181

Part #	Mfg #	Size	Price
091169	076	4" x 25'	
091171	076	6" x 25'	
091172	076	7" x 25'	
091173	076	8" x 25'	
091175	076	10" x 25'	
091176	076	12" x 25'	

R-8.0 Insulated - Grey Jacket - Class 1 Air Duct - UL181

Part #	Mfg #	Size	Price
097743	078	4" x 25'	
101787	078	5" x 25'	
097744	078	6" x 25'	
097745	078	7" x 25'	
097746	078	8" x 25'	
097738	078	10" x 25'	
097739	078	12" x 25'	
097740	078	14" x 25'	
097741	078	16" x 25'	
097742	078	18" x 25'	

Aluminum Flex Duct Uninsulated Flex Duct UL 181 Class 1 Air Duct

- Triple lamination of tough metallized polyester, aluminum foil and polyester
- Wire helix and forms meet requirements of NFPA

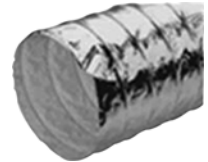

Part #	Mfg #	Size	Price
015420	050	4" x 25'	
015543	050	5" x 25'	
015714	050	6" x 25'	
015763	050	7" x 25'	
015844	050	8" x 25'	
012326	050	10" x 25'	

Ducts, Fittings & Accessories

Flexible Duct

Insulated Sleeves
Foil Sleeve



Ducts, Fittings & Accessories

Part #	Mfg #	Size	R-Value	Price
059879	010	4" x 5'	4.2	
102025	010	5" x 5'	4.2	
044535	010	6" x 5'	4.2	
044534	010	7" x 5'	4.2	
044533	010	8" x 5'	4.2	
102924	010	10" x 5'	4.2	
097732	010	4" x 5'	8.0	
097733	010	6" x 5'	8.0	
097734	010	7" x 5'	8.0	
097735	010	8" x 5'	8.0	

Galvanized Sheet Metal

Galvanized Sheet Iron



Part #	Gauge	Size	Price
010080	30ga	3' x 8'	
076485	28ga	2' x 8'	
010076	28ga	32" x 8'	
010077	28ga	3' x 8'	
010078	28ga	4' x 8'	
010074	26ga	3' x 8'	
010075	26ga	4' x 8'	
010072	22ga	3' x 8'	
010073	22ga	4' x 8'	



Galvanized Sheet Metal

Panning Material No. 48 Panning Material



Part #	Mfg #	Size	Price
179149	481735	16-1/2"(17) x 30	
179150	483235	32" x 35"	

Ducts, Fittings & Accessories

Galvanized Sheet Metal

Galvanized Panning

Galv Joist Panning

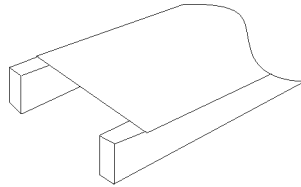

Part #	Size	Price
011026	16-1/2" x 30"	
011027	33" x 30"	

Ducts, Fittings & Accessories

Oval Fittings

Ducts, Fittings & Accessories

Galv Oval Pipe Fittings

Galv Oval 4-Piece Flat 90° Elbow



Part #	Size	Price
011313	6"	

Galv Oval 3-Piece Flat 45° Angle

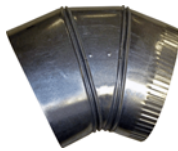

Part #	Size	Price
022270	6"	

Galv Oval 1-Piece Vertical 90° Elbow

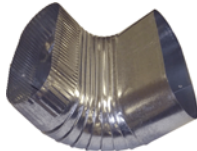

Part #	Size	Price
011312	6"	

Galv Oval 1-Piece Vertical 45° Angle



Part #	Size	Price
018218	6"	
034564	7"	

Galv Oval Stackhead



Part #	Size	Price
011319	10" x 6" - 6"	
045254	12" x 4" - 7"	

Galv 90° Oval Register Box

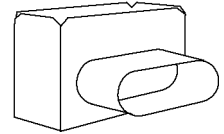

Part #	Size	Price
011321	4" x 10" - 6"	

Galv 90° Round To Oval Boot

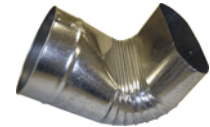

Part #	Size	Price
011317	6"	
026509	7"	

Galv Round To Oval Straight Boot



Part #	Size	Price
011314	6" to 6"	
027404	7" to 7"	

Galv Round To Oval End Boot



Part #	Size	Price
011318	6"	
026511	7"	

Galv Oval Start Collar

Part #	Size	Price
022271	6"	

Oval Fittings

Galv Oval Pipe & Fittings

Galv 113" Oval Pipe

Part #	Size	Price
046953	6"	
046954	7"	

Ducts, Fittings & Accessories

Plenum & Return Air Drops

Ducts, Fittings & Accessories

Galvanized Plenum & Return Air Drops

**Galv Low Profile Cold Air Drop - Support Box
Complete Package - Return Air Pkg**

Part #	Size	Price
012323	20" x 10"	
012324	25" x 10"	

**Galv Cold Air Drop - Slant Back
Complete Package - Return Air Pkg**

Part #	Size	Price
159016	20" x 10"-20" x 14"	
159017	25" x 10"-25" x 14"	

**Galv Cold Air Drop - Slant Back with Filter
Complete Package - Return Air Pkg**

Part #	Size	Price
159023	20" x 25" with 5" Filter	
055507	20" x 25" with 5" Right Angle Filter	

**Galv Cold Air Drop - Slant
Complete Package - Return Air Pkg**

Part #	Size	Price
159019	20" x 10"-20" x 16"	
159020	25" x 10"-25" x 16"	

Galv Cold Air Drop - Duct Kit

- Includes (2) joints of duct, starting collar, duct adapter, and S drives

Part #	Size	Price
023408	20" x 10"	
023410	25" x 10"	

Galv Cold Air Boot - Slant Heel

Part #	Size	Price
024302	16" x 20"	
024303	16" x 25"	

Galv Cold Air Boot - Slant Heel with Filter

Part #	Size	Price
059805	20" x 25" with 5" Filter	
055826	20" x 25" with 5" Right Angle Filter	

Galv Cold Air Boot - Square Heel

Part #	Size	Price
011254	16" x 20"	
011255	16" x 25"	

Galv Adjustable Plenum Top

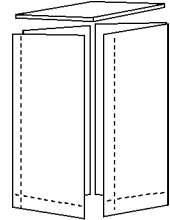

Part #	Size	Price
008172	23" x 23"	
008173	26" x 26"	

Galv Return Air Support Box

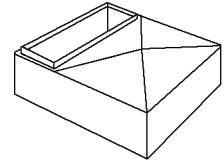

Part #	Description	Price
160421	32" Wide with Filter Drawer	
160422	39" Wide with Filter Drawer	



Plenum & Return Air Drops

Plenum

Plenum for Nordyne with Filter Drawer

Part #	Size	Price
120117	20.25" x 14.25" x 47"	
122818	20.25" x 17.5" x 47"	
122820	20.25" x 21" x 47"	
122821	20.25" x 24.5" x 47"	

Plenum for Ruud

Part #	Size	Price
116829	21" x 14" x 47"	
116830	21" x 17" x 47"	
116831	21" x 21" x 47"	
116832	21" x 24" x 47"	

PVD/PVC Air Duct & Sheets

Ducts, Fittings & Accessories

Heat & Air Duct Pipe



Duct Pipe - Bell on One End

Part #	Mfg #	Size	Price
031122	HA06P	6" x 10'	
031121	HA08P	8" x 10'	
031120	HA10P	10" x 10'	
031119	HA12P	12" x 10'	
031118	HA14P	14" x 10'	
031117	HA16P	16" x 10'	

PVD/PVC Air Duct Fittings

Standard PVC Underground Air Duct Fittings

PVC Air Duct Tee



Part #	Mfg #	Size	Price
058137	T888P	8" x 8" x 8"	

PVC Air Duct Saddle Tee

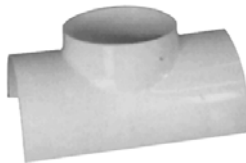

Part #	Mfg #	Size	Price
035155	S086P	8" x 6"	
035156	S106P	10" x 6"	

PVC Air Duct 45° Elbow



Part #	Mfg #	Size	Price
031169	L645P	6"	
031168	L845P	8"	
031167	L105P	10"	
031166	L125P	12"	

PVC Air Duct 90° Elbow



Part #	Mfg #	Size	Price
031163	L690P	6"	

Standard PVC Underground Air Duct Fittings (Continued)

PVC Air Duct 90° Elbow

Part #	Mfg #	Size	Price
031162	L890P	8"	
031161	L109P	10"	
031160	L129P	12"	

PVC Air Duct Coupling

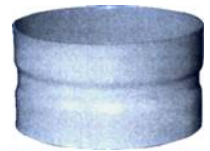

Part #	Mfg #	Size	Price
031194	C600P	6"	
031193	C800P	8"	
031192	C100P	10"	
031191	C120P	12"	
031190	C140P	14"	

PVC Duct Concentric Reducer



Part #	Mfg #	Size	Price
031188	RC86P	8" x 6"	
031187	RC10P	10" x 6"	
031186	RC10P	10" x 8"	
031184	RC12P	12" x 10"	

PVC Air Duct End Cap



Part #	Mfg #	Size	Price
031179	EC60P	6"	
031178	EC80P	8"	
031177	EC10P	10"	
031176	EC12P	12"	

Ducts, Fittings & Accessories

PVD/PVC Air Duct Fittings

Ducts, Fittings & Accessories

PVC Blackmax Duct Saddle Boot



Part #	Mfg #	Size	Price
031199	BM4106	4" x 10" on 6" to 16" Pipe	
035174	BM4128-10	4" x 12" on 8" - 10" Pipe	
031198	BM4128	4" x 12" on 8" Pipe	



Black Max PVC Underground Duct Fittings

PVC 90° Register Boot Box



Part #	Mfg #	Size	Price
031205	B4106	4" x 10" x 6"	
031204	B4126	4" x 12" x 6"	

Rectangular Collars

Rectangular Collars

23 Offset Collar

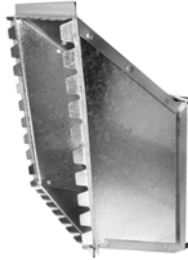

Part #	Mfg #	Size	Price
178788	2388	8" x 8"	
178789	23108	10" x 8"	
178790	23128	12" x 8"	
178791	23148	14" x 8"	
178792	23168	16" x 8"	
178793	23188	18" x 8"	
178794	23208	20" x 8"	
178795	23228	22" x 8"	
178796	23248	24" x 8"	
179231	231010	10" x 10"	
179232	231210	12" x 10"	
179233	231410	14" x 10"	
179234	231610	16" x 10"	
179235	231810	18" x 10"	
179219	232010	20" x 10"	
179230	232410	24" x 10"	
179003	232412	24" x 12"	

Rectangular Collars (Continued)

20 Straight Starting Collar

Part #	Mfg #	Size	Price
178969	202510	25" x 10"	

23AT Transition Collar

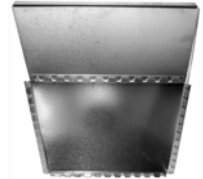

Part #	Mfg #	Size	Price
178878	23AT128	12" x 8"	
178879	23AT148	14" x 8"	
178880	23AT168	16" x 8"	
178881	23AT188	18" x 8"	
179218	23AT2010	20" x 10"	
178882	23AT208	20" x 8"	
178883	23AT228	22" x 8"	
179005	23AT2410	24" x 10"	
179004	23AT2412	24" x 12"	
178884	23AT248	24" x 8"	
178885	23AT3010	30" x 10"	
178886	23AT308	30" x 8"	

20 Straight Starting Collar



Part #	Mfg #	Size	Price
178797	2088	8" x 8"	
178798	20108	10" x 8"	
178799	20128	12" x 8"	
178800	20148	14" x 8"	
178801	20168	16" x 8"	
178802	20188	18" x 8"	
178803	20208	20" x 8"	
178804	20228	22" x 8"	
178805	20248	24" x 8"	
179131	201010	10" x 10"	
179132	202010	20" x 10"	

Rectangular Fittings

Ducts, Fittings & Accessories

Galvanized Duct Collars

Galv Straight Starting Collar

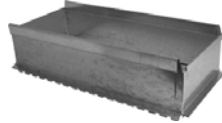

Part #	Size	Price
010955	8" x 8"	
010947	10" x 8"	
010948	12" x 8"	
010949	14" x 8"	
010950	16" x 8"	
010951	18" x 8"	
010952	20" x 8"	
046899	20" x 10"	
010953	22" x 8"	
010954	24" x 8"	
026677	25" x 10"	
224763	30" x 8"	

Galv Transition Takeoff Collar Center

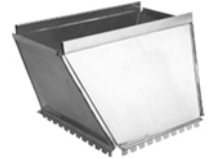

Part #	Size	Price
011028	12" x 8"	
011029	14" x 8"	
011030	16" x 8"	
011031	18" x 8"	
011032	20" x 8"	
035899	20" x 10"	
011033	22" x 8"	
011034	24" x 8"	
033651	24" x 10"	
033650	24" x 12"	
030893	30" x 8"	

Galv Offset Takeoff Collar



Part #	Size	Price
010946	8" x 8"	
010938	10" x 8"	
010939	12" x 8"	
010940	14" x 8"	
116860	14" x 10"	
010941	16" x 8"	
116861	16" x 10"	
010942	18" x 8"	
010943	20" x 8"	
035900	20" x 10"	
010944	22" x 8"	
010945	24" x 8"	
033649	24" x 10"	
033648	24" x 12"	



Rectangular Duct

Rectangular Duct Trunk Duct

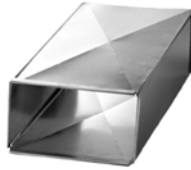

60" Joint Length

Part #	Mfg #	Size	Price
179194	TD6088	8" x 8"	
179195	TD60108	10" x 8"	
179196	TD60128	12" x 8"	
179197	TD60148	14" x 8"	
179198	TD60168	16" x 8"	
179199	TD60188	18" x 8"	
179200	TD60208	20" x 8"	
179201	TD60228	22" x 8"	
179202	TD60248	24" x 8"	
179191	TD60268	26" x 8"	
179192	TD60288	28" x 8"	
179193	TD60308	30" x 8"	
179203	TD601010	10" x 10"	
179204	TD601210	12" x 10"	
179205	TD601410	14" x 10"	
179206	TD601610	16" x 10"	
179207	TD601810	18" x 10"	
179208	TD602010	20" x 10"	
179209	TD602410	24" x 10"	
179210	TD602510	25" x 10"	
179211	TD603010	30" x 10"	

48" Joint Length

Part #	Mfg #	Size	Price
179188	TD482010	20" x 10"	
179186	TD482410	24" x 10"	
179187	TD482412	24" x 12"	

30" Joint Length

Part #	Mfg #	Size	Price
179355	TD302510	25" x 10"	

Rectangular Duct

Ducts, Fittings & Accessories

Galvanized Duct

Galv Duct 32" Button-Lock

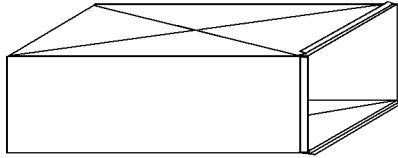

Part #	Size	Price
019920	20" x 10"	
011021	25" x 10"	

Galv Duct 4' Button-Lock

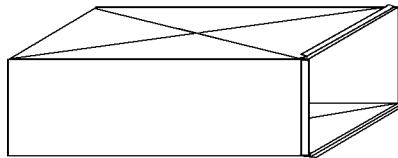

Part #	Size	Price
035901	20" x 10"	
033653	24" x 10"	
033652	24" x 12"	

Galv Duct 5' Button-Lock

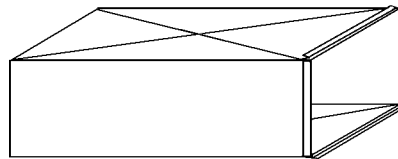

Part #	Size	Price
011025	8" x 8"	
011013	10" x 8"	
011014	12" x 8"	
011015	14" x 8"	
011016	16" x 8"	
011017	18" x 8"	
011018	20" x 8"	
011019	22" x 8"	
011020	24" x 8"	
062795	26" x 8"	
062794	28" x 8"	
110667	30" x 8"	
092658	12" x 10"	
092657	14" x 10"	
072107	16" x 10"	
092627	18" x 10"	
101661	20" x 10"	
101662	25" x 10"	

Galvanized Duct (Continued)

Galv Duct 5' Button-Lock

Part #	Size	Price
101605	30" x 10"	

Trunk Duct



Part #	Size	Price
177728	10"x8"x48"	
177732	12"x8"x48"	
177729	14"x8"x48"	
177739	16"x8"x48"	
177731	18"x8"x48"	
177734	20"x8"x48"	
177735	22"x8"x48"	
177736	24"x8"x48"	
159471	10"x10"x60"	
159470	24"x10"x60"	
152880	25"x12"x60"	

Rectangular Elbows

Rectangular Fittings

13 45° Flat (Broadway) Angle Radius Throat



Part #	Mfg #	Size	Price
178858	1388	8" x 8"	
178859	13108	10" x 8"	
178860	13128	12" x 8"	
178861	13148	14" x 8"	
178862	13168	16" x 8"	
178863	13188	18" x 8"	
178864	13208	20" x 8"	
178865	13228	22" x 8"	
178866	13248	24" x 8"	
178867	13308	30" x 8"	
179265	131010	10" x 10"	
181829	131210	12" x 10"	
179266	131410	14" x 10"	
179267	131610	16" x 10"	
179268	131810	18" x 10"	
179269	132010	20" x 10"	
179270	132210	22" x 10"	
179271	132410	24" x 10"	
179272	133010	30" x 10"	

13S 45° Flat (Broadway) Angle Square Throat

Part #	Mfg #	Size	Price
178652	13S1210	12" x 10"	
179225	13S2510	25" x 10"	

15 45° Vertical (Shortway) Angle Radius Throat

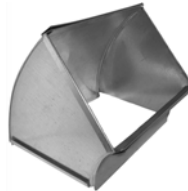

Part #	Mfg #	Size	Price
178846	1588	8" x 8"	
178847	15108	10" x 8"	
178848	15128	12" x 8"	
178849	15148	14" x 8"	

Rectangular Fittings (Continued)

15 45° Vertical (Shortway) Angle Radius Throat

Part #	Mfg #	Size	Price
178850	15168	16" x 8"	
178851	15188	18" x 8"	
178853	15208	20" x 8"	
178855	15228	22" x 8"	
178856	15248	24" x 8"	
178857	15308	30" x 8"	
179255	151010	10" x 10"	
179257	151210	12" x 10"	
179258	151410	14" x 10"	
179259	151610	16" x 10"	
179260	151810	18" x 10"	
179249	152010	20" x 10"	
179261	152210	22" x 10"	
179263	152410	24" x 10"	
179264	153010	30" x 10"	

15S 45° Vertical (Shortway) Angle Square Throat

Part #	Mfg #	Size	Price
179224	15S2510	25" x 10"	

14 90° Flat (Broadway) Elbow Radius Throat

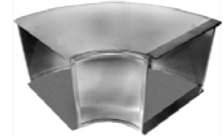

Part #	Mfg #	Size	Price
178868	1488	8" x 8"	
178869	14108	10" x 8"	
178870	14128	12" x 8"	
178871	14148	14" x 8"	
178872	14168	16" x 8"	
178873	14188	18" x 8"	
178874	14208	20" x 8"	
178875	14228	22" x 8"	
178876	14248	24" x 8"	
178877	14308	30" x 8"	
179298	141010	10" x 10"	
179236	141210	12" x 10"	
179222	142510	25" x 10"	
179275	143010	30" x 10"	



Rectangular Elbows

Ducts, Fittings & Accessories

14S 90° Flat (Broadway) Elbow Square Throat

Part #	Mfg #	Size	Price
180277	14S148	14" x 8"	
179243	14S1410	14" x 10"	
179244	14S1610	16" x 10"	
179245	14S1810	18" x 10"	
179246	14S2010	20" x 10"	
179247	14S2410	24" x 10"	
179248	14S2412	24" x 12"	

16 Vertical (Shortway) Elbow Radius Throat

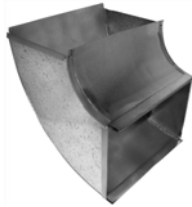

Part #	Mfg #	Size	Price
178835	1688	8" x 8"	
178836	16108	10" x 8"	
178837	16128	12" x 8"	
178838	16148	14" x 8"	
178839	16168	16" x 8"	
178840	16188	18" x 8"	
178841	16208	20" x 8"	
178842	16228	22" x 8"	
178843	16248	24" x 8"	
178845	16308	30" x 8"	
181831	161010	10" x 10"	
181830	161210	12" x 10"	
179274	163010	30" x 10"	

16S Vertical (Shortway) Elbow Square Throat

Part #	Mfg #	Size	Price
179237	16S1410	14" x 10"	
179238	16S1610	16" x 10"	
179239	16S1810	18" x 10"	
179240	16S2010	20" x 10"	
179241	16S2410	24" x 10"	
179221	16S2510	25" x 10"	
179242	16S2412	24" x 12"	

Rectangular Fittings

Galvanized Duct Elbows
Galv 45° Vertical Shortway Angle

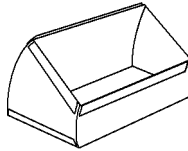

Part #	Size	Price
010995	8" x 8"	
010988	10" x 8"	
010989	12" x 8"	
150760	12" x 10"	
010990	14" x 8"	
150759	14" x 10"	
010991	16" x 8"	
150758	16" x 10"	
010992	18" x 8"	
150756	18" x 10"	
010993	20" x 8"	
145238	20" x 10"	
048613	22" x 8"	
010994	24" x 8"	
075912	24" x 10"	
133193	25" x 10"	
150755	30" x 10"	

Galv 45° Horizontal Longway Angle

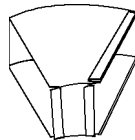

Part #	Size	Price
046407	8" x 8"	
010996	10" x 8"	
010997	12" x 8"	
150741	12" x 10"	
010998	14" x 8"	
150742	14" x 10"	
010999	16" x 8"	
150743	16" x 10"	
011000	18" x 8"	
150744	18" x 10"	
011001	20" x 8"	
150745	20" x 10"	
011002	22" x 8"	
011003	24" x 8"	
133195	25" x 10"	

Galvanized Duct Elbows (Continued)
Galv 45° Horizontal Longway Angle

Part #	Size	Price
108604	30" x 8"	
150747	30" x 10"	

Galv 90° Vertical Shortway Elbow with Mitered Throat

• 2" x 2" Throat

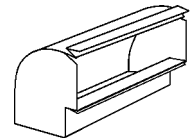

Part #	Size	Price
091104	8" x 8"	
091103	10" x 8"	
091105	12" x 8"	
091106	14" x 8"	
091119	14" x 10"	
091107	16" x 8"	
091120	16" x 10"	
091113	18" x 8"	
091121	18" x 10"	
091114	20" x 8"	
091122	20" x 10"	
091115	22" x 8"	
091116	24" x 8"	
091123	24" x 10"	
091124	24" x 12"	
133190	25" x 10"	
091117	30" x 8"	

Galv 90° Horizontal Longway Elbow with Mitered Throat

• 2" x 2" Throat

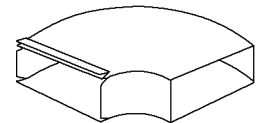

Part #	Size	Price
091127	8" x 8"	
091128	10" x 8"	
091129	12" x 8"	
091130	14" x 8"	
091136	14" x 10"	
091131	16" x 8"	
091137	16" x 10"	
091132	18" x 8"	
091138	18" x 10"	
091133	20" x 8"	
091139	20" x 10"	

Rectangular Fittings

Ducts, Fittings & Accessories

Galvanized Duct Elbows (Continued)

Galv 90° Horizontal Longway Elbow with Mitered Throat

Part #	Size	Price
091134	22" x 8"	
091135	24" x 8"	
091141	24" x 12"	
133192	25" x 10"	
108605	30" x 8"	

Rectangular Miscellaneous

Reducers 35 Duct Reducer



Part #	Mfg #	Size	Price
179608	352	0-2"	
179609	354	0-4"	
181987	356	0-6"	
181988	358	0-8"	
178887	35210	10"/0-2"	
178888	35410	10"/0-4"	
178889	35610	10"/0-6"	
178890	35810	10"/0-8"	

17 Duct Transition



Part #	Mfg #	Size	Price
179220	172010208	20" x 10"	
179007	172410248	24" x 10"	
179006	172412248	24" x 12"	

Caps 21 End Cap



Part #	Mfg #	Size	Price
178891	2188	8" x 8"	
178892	21108	10" x 8"	
178893	21128	12" x 8"	
178894	21148	14" x 8"	
178895	21168	16" x 8"	
178896	21188	18" x 8"	
178897	21208	20" x 8"	
178898	21228	22" x 8"	

Caps (Continued) 21 End Cap

Part #	Mfg #	Size	Price
178899	21248	24" x 8"	
178900	21308	30" x 8"	
179250	211210	12" x 10"	
179251	212010	20" x 10"	
179252	212410	24" x 10"	
179148	212510	25" x 10"	

Register Frames 31 Return Air Frame



Part #	Mfg #	Size	Price
179102	31146	14" x 6"	
179103	31246	24" x 6"	
179104	31306	30" x 6"	

31PF Plaster Frame

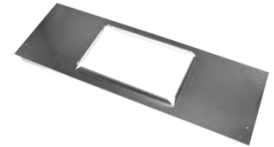

Part #	Mfg #	Size	Price
179105	31PF16410	F/16", 4" x 10"	
179106	31PF16412	F/16", 4" x 12"	
179107	31PF410	F/24", 4" x 10"	
179109	31PF412	F/24", 4" x 12"	

Boots

51FCRD Straight Ext Boot w/Flange & Ceiling Radiation Damper

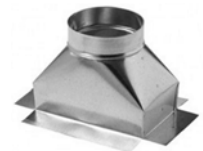

Part #	Mfg #	Size	Price
226531	51FCRD	4" x 12" x 6"	



Rectangular Miscellaneous

'S' & Drive Cleats S Clip



Part #	Mfg #	Size	Price
179174	6S60	60"	

Drive Clips

Part #	Mfg #	Size	Price
179175	8D8	8"	
179176	8D10	10"	
179178	8D60	60"	

Ducts, Fittings & Accessories

Rectangular Fittings

Galvanized Duct Fittings

Galv Duct End Cap



Part #	Size	Price
011049	8" x 8"	
011040	10" x 8"	
011041	12" x 8"	
011042	14" x 8"	
011043	16" x 8"	
011044	18" x 8"	
011045	20" x 8"	
011046	22" x 8"	
011047	24" x 8"	
011048	30" x 8"	
111958	20" x 10"	
109319	24" x 10"	
035597	25" x 10"	

Galv Increaser or Reducer Straight Side

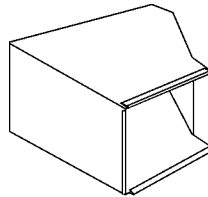

Part #	Size	Price
035902	20" x 10"-20" x 8"	
033647	24" x 10"-24" x 8"	
033654	24" x 12"-24" x 8"	

Galv Drive Cleat

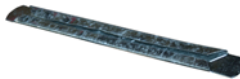

Part #	Size	Price
011170	8"	
011168	10"	
022826	12"	
011169	60"	

Galv Flat S-Cleat



Part #	Size	Price
011166	60"	

Galv Standing S-Cleat

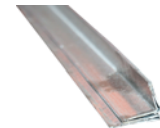

Part #	Size	Price
011163	60"	
011162	120"	

Galv Plaster Frame - Rectangular

Part #	Size	Price
096773	4" x 10" - 16" On Center	
096775	4" x 10" - 24" On Center	
096776	4" x 12" - 24" On Center	
011256	6" x 14"	
026392	6" x 24"	
011257	6" x 30"	

Galv Plaster Frame - Round

Part #	Size	Price
102571	60"	

Galv Filter Rack



Part #	Size	Price
036258	16" x 20" x 1"	
011124	16" x 20" x 6"	
029512	16" x 25" x 1"	
018112	16" x 25" x 6"	

Ducts, Fittings & Accessories

Rectangular Fittings

Galv Reducer

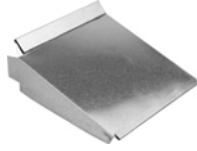

Part #	Size	Price
166231	0-2"	
166233	0-4"	
166234	0-6"	
166235	0-8"	

Ducts, Fittings & Accessories



Rectangular Fittings

Speedi-Boot™ Boot Hanger

- Telescoping arms
- Dust and debris cover
- Air tight gasket
- Rigid mud-ring and galvanized frame



Part #	Mfg #	Size	Price
080008	SBH-410	4" x 10"	
080009	SBH-412	4" x 12"	

Round Boots

Ducts, Fittings & Accessories

Round Boots

24R 90° Register Boot



Part #	Mfg #	Size	Price
187966	24R2104	2-1/4" x 10" x 4"	
179047	24R2105	2-1/4" x 10" x 5"	
179048	24R2106	2-1/4" x 10" x 6"	
179049	24R2125	2-1/4" x 12" x 5"	
179046	24R2126	2-1/4" x 12" x 6"	
179050	24R2127	2-1/4" x 12" x 7"	
179051	24R2146	2-1/4" x 14" x 6"	
179052	24R2147	2-1/4" x 14" x 7"	
179053	24R4104	4" x 10" x 4"	
179054	24R4105	4" x 10" x 5"	
179055	24R4106	4" x 10" x 6"	
179056	24R4107	4" x 10" x 7"	
179057	24R4125	4" x 12" x 5"	
179058	24R4126	4" x 12" x 6"	
179059	24R4127	4" x 12" x 7"	
179060	24R4128	4" x 12" x 8"	
179061	24R4146	4" x 14" x 6"	
179062	24R4147	4" x 14" x 7"	
179063	24R4148	4" x 14" x 8"	
179064	24R6106	6" x 10" x 6"	
179065	24R6107	6" x 10" x 7"	
179066	24R6127	6" x 12" x 7"	
179067	24R6128	6" x 12" x 8"	
179068	24R6148	6" x 14" x 8"	

27R Straight Register Boot



Part #	Mfg #	Size	Price
179024	27R2105	2-1/4" x 10" x 5"	
179025	27R2106	2-1/4" x 10" x 6"	
179026	27R2125	2-1/4" x 12" x 5"	
179027	27R2126	2-1/4" x 12" x 6"	
179028	27R2146	2-1/4" x 14" x 6"	
179029	27R2147	2-1/4" x 14" x 7"	
179030	27R4104	4" x 10" x 4"	

Round Boots (Continued)

27R Straight Register Boot

Part #	Mfg #	Size	Price
179031	27R4105	4" x 10" x 5"	
179032	27R4106	4" x 10" x 6"	
179033	27R4107	4" x 10" x 7"	
179034	27R4126	4" x 12" x 6"	
179035	27R4127	4" x 12" x 7"	
179036	27R4128	4" x 12" x 8"	
179037	27R4146	4" x 14" x 6"	
179039	27R4147	4" x 14" x 7"	
179040	27R4148	4" x 14" x 8"	
179041	27R6106	6" x 10" x 6"	
179042	27R6126	6" x 12" x 6"	
179043	27R6127	6" x 12" x 7"	
179044	27R6128	6" x 12" x 8"	
179045	27R6148	6" x 14" x 8"	

28R Center End Register Boot



Part #	Mfg #	Size	Price
187967	28R2105	2-1/4" x 10" x 4"	
179069	28R2105	2-1/4" x 10" x 5"	
179070	28R2106	2-1/4" x 10" x 6"	
179071	28R2125	2-1/4" x 12" x 5"	
179072	28R2126	2-1/4" x 12" x 6"	
178655	28R2127	2-1/4" x 12" x 7"	
179073	28R2146	2-1/4" x 14" x 6"	
179130	28R4104	4" x 10" x 4"	
179074	28R4105	4" x 10" x 5"	
179075	28R4106	4" x 10" x 6"	
179076	28R4126	4" x 12" x 6"	
179077	28R4127	4" x 12" x 7"	
179078	28R4128	4" x 12" x 8"	
179079	28R4146	4" x 14" x 6"	
179080	28R4147	4" x 14" x 7"	
179081	28R4148	4" x 14" x 8"	
179082	28R6106	6" x 10" x 6"	



Round Boots

28RR Right End Register Boot



Part #	Mfg #	Size	Price
179092	28RR2106	2-1/4" x 10" x 6"	
179093	28RR2126	2-1/2" x 12" x 6"	
179094	28RR2127	2-1/4" x 12" x 7"	
179095	28RR2146	2-1/4" x 14" x 6"	
179096	28RR4105	4" x 10" x 5"	
179097	28RR4106	4" x 10" x 6"	
179098	28RR4126	4" x 12" x 6"	
179099	28RR4127	4" x 12" x 7"	

28RL Left End Register Boot



Part #	Mfg #	Size	Price
179083	28RL2106	2-1/4" x 10" x 6"	
179084	28RL2126	2-1/2" x 12" x 6"	
179085	28RL2127	2-1/4" x 12" x 7"	
179087	28RL2146	2-1/4" x 14" x 6"	
179088	28RL4105	4" x 10" x 5"	
179089	28RL4106	4" x 10" x 6"	
179090	28RL4126	4" x 12" x 6"	
179091	28RL4127	4" x 12" x 7"	

24RWE 90° Basement Head Boot



Part #	Mfg #	Size	Price
181406	24RWE4106	4" x 10" x 6"	
179126	24RWE6106	6" x 10" x 6"	

Round Fittings

Ducts, Fittings & Accessories

Galvanized Register Boots
Galv Straight Back Register Boot



Part #	Size	Price
011187	2-1/4" x 10"-5"	
011188	2-1/4" x 10"-6"	
011189	2-1/4" x 12"-5"	
011190	2-1/4" x 12"-6"	
011192	2-1/4" x 14"-6"	
101809	4" x 10"-4"	
011194	4" x 10"-5"	
011195	4" x 10"-6"	
011196	4" x 10"-7"	
011197	4" x 12"-6"	
011198	4" x 12"-7"	
019300	4" x 12"-8"	
011199	4" x 14"-6"	
011200	4" x 14"-7"	
011201	4" x 14"-8"	
011202	6" x 10"-6"	
011203	6" x 12"-6"	
011204	6" x 12"-7"	
011205	6" x 12"-8"	
011206	6" x 14"-8"	

Galv Register Boot 90° Angle



Part #	Size	Price
011208	2-1/4" x 10"-5"	
011209	2-1/4" x 10"-6"	
011210	2-1/4" x 12"-5"	
011211	2-1/4" x 12"-6"	
011212	2-1/4" x 12"-7"	
011213	2-1/4" x 14"-6"	
101807	4" x 10"-4"	
011215	4" x 10"-5"	
011216	4" x 10"-6"	
011217	4" x 10"-7"	

Galvanized Register Boots (Continued)
Galv Register Boot 90° Angle

Part #	Size	Price
011218	4" x 12"-6"	
011219	4" x 12"-7"	
011220	4" x 12"-8"	
011221	4" x 14"-6"	
011222	4" x 14"-7"	
011223	4" x 14"-8"	
011224	6" x 10"-6"	
011226	6" x 12"-7"	
011227	6" x 12"-8"	
011228	6" x 14"-8"	

Galv Register End Boot - Center



Part #	Size	Price
011229	2-1/4" x 10"-5"	
011230	2-1/4" x 10"-6"	
011231	2-1/4" x 12"-5"	
011232	2-1/4" x 12"-6"	
011233	2-1/4" x 12"-7"	
011234	2-1/4" x 14"-6"	
101808	4" x 10"-4"	
011236	4" x 10"-5"	
011237	4" x 10"-6"	
011238	4" x 12"-6"	
011239	4" x 12"-7"	
056085	4" x 12"-8"	
011240	4" x 14"-6"	
011241	4" x 14"-7"	
011242	4" x 14"-8"	

Galv Register End Boot Left

Part #	Size	Price
011243	2-1/4" x 10"-6"	
011245	2-1/4" x 12"-6"	
101886	2-1/4" x 12"-7"	
101888	4" x 10"-5"	
011247	4" x 10"-6"	
011248	4" x 12"-6"	
025227	4" x 12"-7"	

Round Fittings

Galv Register End Boot Right

Part #	Size	Price
011249	2-1/4" x 10"-6"	
011250	2-1/4" x 12"-6"	
101887	2-1/4" x 12"-7"	
101889	4" x 10"-5"	
011252	4" x 10"-6"	
011253	4" x 12"-6"	
025228	4" x 12"-7"	

Galv Basement Boot with Wings

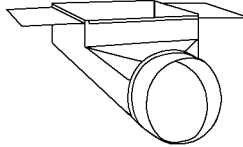

Part #	Size	Price
125132	4" x 10"-6"	
225533	4" x 12"-6" w/ 24" Frame	
035596	4" x 12"-6" w/ 18" Frame	
058646	6" x 10"-6"-16" On Center	

Galv Register Boot with Frame

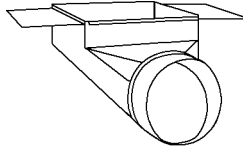

Part #	Size	Price
129228	4" x 10"-6" with 16" Frame	
132359	4" x 12"-6" with 24" Frame	

Galv Toe Kick Boot

Part #	Size	Price
111509	2-1/4" x 12" -6"	

Ducts, Fittings & Accessories

Round Fittings

Galvanized Collars

1149CR Long Collar



Part #	Mfg #	Size	Price
061493	70506200	4"	
011273	70506600	5"	
011274	70507000	6"	
011275	70507400	7"	
011276	70507800	8"	

1149CD Long Collar with Damper



Part #	Mfg #	Size	Price
061488	70511000	6"	
061489	70511400	7"	
061490	70511800	8"	
061491	70512600	10"	
061492	70513000	12"	

Round Collars

Round Collars

97LS Long Style Flat Collar



Part #	Mfg #	Size	Price
178996	97LS4	4"	
178997	97LS5	5"	
178998	97LS6	6"	
178999	97LS7	7"	
179000	97LS8	8"	
179001	97LS10	10"	
179002	97LS12	12"	
178975	97LS14	14"	
179128	97LS16	16"	

97LSWD Long Style Flat Collar with Damper



Part #	Mfg #	Size	Price
178994	97LSWD4	4"	
178995	97LSWD6	6"	
181932	97LSWD8	8"	

97 Start Collar

- Crimped



Part #	Mfg #	Size	Price
178809	973	3"	
178810	974	4"	
178811	975	5"	
178812	976	6"	
178813	977	7"	
178814	978	8"	
178815	979	9"	
178816	9710	10"	
178817	9712	12"	
178818	9714	14"	
178819	9716	16"	

Round Collars (Continued)

97 Start Collar

Part #	Mfg #	Size	Price
178820	9718	18"	
178821	9720	20"	

97NC Start Collar

- No Crimp

Part #	Mfg #	Size	Price
178822	973NC	3"	
178824	974NC	4"	
178825	975NC	5"	
178826	976NC	6"	
178827	977NC	7"	
178829	978NC	8"	
178830	979NC	9"	
178831	9710NC	10"	
178832	9712NC	12"	
178833	9714NC	14"	
178834	9716NC	16"	

97FG Ductboard Spin Collar



Part #	Mfg #	Size	Price
179142	97FG6	6"	
179144	97FG7	7"	
179145	97FG8	8"	
179146	97FG10	10"	

156 Spin Collar for Metal



Part #	Mfg #	Size	Price
179133	1566	6"	
179134	1568	8"	
179135	15612	12"	



Round Collars

Ducts, Fittings & Accessories

156D Spin Collar for Metal w/ Damper



Part #	Mfg #	Size	Price
179136	156D6	6"	
179139	156D8	8"	
179140	156D10	10"	
179141	156D12	12"	

84ST Ductboard Collar 1-1/2" Tabs



Part #	Mfg #	Size	Price
188440	84ST6	6"	
188441	84ST7	7"	
188442	84ST8	8"	

Round Fittings

Galvanized Collars

Galv Stub Collar - Plain

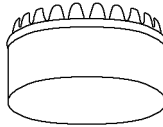

Part #	Size	Price
010973	4"	
010974	5"	
010975	6"	
010976	7"	
010977	8"	
010978	9"	
010968	10"	
010969	12"	
010970	14"	

Galv Top Collar - Crimped



Part #	Size	Price
010961	3"	
010962	4"	
010963	5"	
010964	6"	
010965	7"	
010966	8"	
010967	9"	
010956	10"	
010957	12"	
010958	14"	
010959	16"	
010960	18"	

Start Collar with Ring

Part #	Size	Price
157735	4"	
157736	5"	
157737	6"	
157738	7"	
157739	8"	
157741	10"	
157742	12"	

Galv Duct Board Collar without Damper

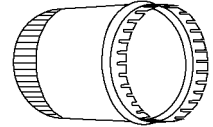

Part #	Size	Price
011272	10"	
020010	12"	
023906	14"	
023907	16"	

Galv Duct Board Spin-In Collar without Damper

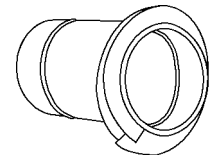

Part #	Size	Price
011283	6"	
011284	7"	
011285	8"	

Galv Metal Spin-In Collar with Damper



Part #	Size	Price
028049	6"	
028050	8"	
028051	10"	

Galv Round to Round Self-Adhesive Takeoff



Part #	Size	Price
072244	6"	
184158	7"	
073575	8"	

Ducts, Fittings & Accessories

Round Fittings

Round to Round Self-Adhesive Takeoff



Part #	Size	Price
172058	5"	
164710	6"	
164711	7"	
164712	8"	
226843	10"	
171082	12"	

Ducts, Fittings & Accessories



Round Elbows

90° Round Elbows



90° 24ga Elbow

Part #	Mfg #	Size	Price
178760	90524	5"	
178761	90624	6"	
178762	90724	7"	
178763	90824	8"	
178764	90924	9"	
178765	901024	10"	
178766	901224	12"	
178767	901424	14"	
178768	901624	16"	
178769	901824	18"	

90° 26ga Elbow

Part #	Mfg #	Size	Price
178749	90326	3"	
178750	90426	4"	
178751	90526	5"	
178752	90626	6"	
178753	90726	7"	
178754	90826	8"	
178755	901026	10"	
178756	901226	12"	
178757	901426	14"	
178758	901626	16"	

90° 28ga Elbow

Part #	Mfg #	Size	Price
178746	90328	3"	
178747	90428	4"	
178745	901228	12"	
178748	901428	14"	

90° 30ga Elbow

Part #	Mfg #	Size	Price
178738	90330	3"	
178739	90430	4"	
178740	90530	5"	
178637	90630	6"	

90° Round Elbows (Continued)

90° 30ga Elbow

Part #	Mfg #	Size	Price
178741	90730	7"	
178742	90830	8"	
178743	90930	9"	
178744	901030	10"	

45° Round Elbows



45° 30ga Elbow

Part #	Mfg #	Size	Price
178770	45530	5"	
178771	45630	6"	
178772	45730	7"	

Ducts, Fittings & Accessories

Round Elbows

Ducts, Fittings & Accessories

Galvanized Round Elbows



Galv 45° 30ga Elbow

Part #	Size	Price
021248	5"	
010936	6"	

Galv 90° 30ga Elbow

Part #	Size	Price
010899	3"	
010900	4"	
010901	5"	
134912	6"	
010903	7"	
010904	8"	
010906	9"	
010897	10"	
010898	12"	

Galv 90° 28ga Elbow

Part #	Size	Price
010908	3"	
010909	4"	
153110	9"	
153118	10"	
021253	12"	
010907	14"	

Galv 90° 26ga Elbow

Part #	Size	Price
010911	3"	
010912	4"	
028849	5"	
022328	6"	
026496	7"	
043462	8"	
043463	10"	
043464	12"	
021252	14"	
010910	16"	

Galv 90° 24ga Elbow

Part #	Size	Price
010916	5"	
010917	6"	
010918	7"	
010919	8"	
010920	9"	
010913	10"	
010914	12"	
010915	14"	
030837	16"	
037283	18"	

Galv Round to Round Self-Adhesive 90° Takeoff



Part #	Size	Price
116248	5"	
098648	6"	
116249	7"	
116250	8"	

Galv Round Adjustable 90° Elbow with Adhesive

- Shipped straight not turned



Part #	Size	Price
154621	6"	



Round Pipe

Round Pipe

SL12 12" Joint Round Pipe



30 Gauge

Part #	Mfg #	Size	Price
178727	SL120430	4" x 1'	
178630	SL120530	5" x 1'	
178631	SL120630	6" x 1'	
178632	SL120730	7" x 1'	

SL24 24" Joint Round Pipe



24 Gauge

Part #	Mfg #	Size	Price
178698	SL24524	5" x 2'	
178699	SL24624	6" x 2'	
178700	SL24724	7" x 2'	
178701	SL24824	8" x 2'	
178702	SL24924	9" x 2'	
178703	SL241024	10" x 2'	
178704	SL241224	12" x 2'	
178705	SL241424	14" x 2'	
178706	SL241624	16" x 2'	
178707	SL241824	18" x 2'	

26 Gauge

Part #	Mfg #	Size	Price
178680	SL24326	3" x 2'	
178681	SL24426	4" x 2'	
178682	SL24526	5" x 2'	
178683	SL24626	6" x 2'	
178684	SL241426	14" x 2'	
178685	SL241626	16" x 2'	
178687	SL241826	18" x 2'	

30 Gauge

Part #	Mfg #	Size	Price
178671	SL24330	3" x 2'	
178672	SL24430	4" x 2'	
178673	SL24530	5" x 2'	
178674	SL24630	6" x 2'	
178675	SL24730	7" x 2'	
178676	SL24830	8" x 2'	
178677	SL24930	9" x 2'	
178678	SL241030	10" x 2'	
178679	SL241230	12" x 2'	

SL60 60" Joint Round Pipe



26 Gauge

Part #	Mfg #	Size	Price
178729	SL60426	4" x 5'	
178663	SL60526	5" x 5'	
178664	SL60626	6" x 5'	
178666	SL60726	7" x 5'	
178667	SL60826	8" x 5'	
178669	SL60926	9" x 5'	
178670	SL601026	10" x 5'	
178728	SL601226	12" x 5'	
178730	SL601426	14" x 5'	
178731	SL601626	16" x 5'	

30 Gauge

Part #	Mfg #	Size	Price
178633	SL60330	3" x 5'	
178634	SL60430	4" x 5'	
178635	SL60530	5" x 5'	
178636	SL60630	6" x 5'	
178658	SL60730	7" x 5'	
178659	SL60830	8" x 5'	
178661	SL60930	9" x 5'	
178662	SL601030	10" x 5'	

Ducts, Fittings & Accessories

Round Pipe

Ducts, Fittings & Accessories

Galvanized Sheet Metal Pipe



Galv Sheet Metal 24" 30ga Pipe

Part #	Size	Price
010786	3"	
010788	4"	
010791	5"	
010794	6"	
010797	7"	
010799	8"	
010801	9"	
010783	10"	
010785	12"	

Galv Sheet Metal 24" 26ga Pipe

Part #	Size	Price
010775	3"	
010776	4"	
010778	5"	
010779	6"	
010773	14"	
010774	16"	
021251	18"	

Galv Sheet Metal 24" 24ga Pipe

Part #	Size	Price
010768	5"	
010769	6"	
010770	7"	
010771	8"	
010772	9"	
010764	10"	
010765	12"	
010766	14"	
010767	16"	

Galvanized Snap Lock Pipe

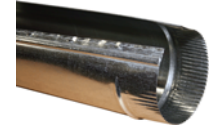

Galv Snap Lock 60" 30ga Pipe

Part #	Size	Price
010787	3"	
010789	4"	
010792	5"	
010795	6"	
010798	7"	
010800	8"	
075283	9"	
010784	10"	

Galv Snap Lock 60" 26ga Pipe

Part #	Size	Price
010777	4"	
028848	5"	
026464	6"	
025025	7"	
043461	8"	
033458	10"	
020976	12"	
105628	14"	

Galv Snap Lock 120" 30ga Pipe

Part #	Size	Price
129152	4"	
010790	5"	
010793	6"	
010796	7"	

Round Takeoffs

Round Takeoffs

63A Adjustable Takeoff



Part #	Mfg #	Size	Price
178773	63A5	5"	
178774	63A6	6"	
178775	63A7	7"	
178776	63A8	8"	

62 Top Takeoff



Part #	Mfg #	Size	Price
179013	625	5"	
179014	626	6"	
179015	627	7"	
179016	628	8"	

63 Side Takeoff



Part #	Mfg #	Size	Price
179010	636	6"	
179011	637	7"	
179012	638	8"	

64 Double Top Takeoff

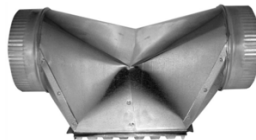

Part #	Mfg #	Size	Price
179018	646	6"	

EP15 Full Tab Round to Round Adjustable Takeoff



Part #	Mfg #	Size	Price
178779	EP1565	6" x 5"	
178780	EP1576	7" x 6"	
178781	EP1587	8" x 7"	
178782	EP1598	9" x 8"	

HT15 Half Tab Round to Round Adjustable Takeoff



Part #	Mfg #	Size	Price
190191	HT1564	6" x 4"	
178638	HT1576	7" x 6"	
178787	HT1587	8" x 7"	

AT63 Air-Tite Side Takeoff (Square to Round)



Part #	Mfg #	Size	Price
179228	AT638	8"	
179226	AT6310	10"	

ATT Air-Tite Takeoff



Part #	Mfg #	Size	Price
179253	ATT6	6"	
179254	ATT8	8"	



Round Takeoffs

ATTRP45 Air-Tite 45° Saddle Takeoff

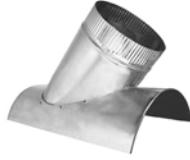

Ducts, Fittings & Accessories

Part #	Mfg #	Size	Price
189069	ATTRP4510	10"	

Round Fittings

Galvanized Takeoffs

Galv Side Takeoff



Part #	Size	Price
011142	6"	
011143	7"	

**Galv Adjustable Top Takeoff
Sheet Metal**

Part #	Size	Price
111661	5"	
111662	6"	
111663	7"	

Galv Top Takeoff



Part #	Size	Price
011145	6"	

Galv Adjustable Takeoffs with 2" Rise



Part #	Size	Price
011149	5"	
011150	6"	
011151	7"	
011152	8"	

**Galv Adjustable Takeoff
Round To Round Full Tab**



Part #	Size	Price
011155	5"	
011156	6"	
011157	7"	

Galvanized Takeoffs (Continued)

**Galv Adjustable Takeoff
Round To Round Full Tab**

Part #	Size	Price
011158	8"	

**Galv Adjustable Takeoff
Round To Round Half Tab**



Part #	Size	Price
051557	6"	
101811	7"	

Galv Adjustable Round Pivot Takeoff

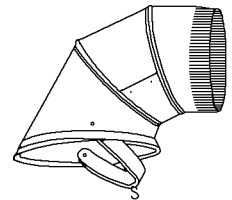

Part #	Size	Price
011153	6"	

Ducts, Fittings & Accessories

Round Tees & Wyes

Ducts, Fittings & Accessories

Round Tees

Free Flow Tee



24 Gauge Free Flow Tee

Part #	Mfg #	Size	Price
180537	1060624	6"	
180538	1060724	7"	
180539	1060824	8"	
180541	10601024	10"	
180542	10601224	12"	
180543	10601424	14"	

26 Gauge Free Flow Tee

Part #	Mfg #	Size	Price
180534	1060326	3"	
180535	1060426	4"	
180536	1060526	5"	
180688	1060626	6"	
180689	1060726	7"	
180690	1060826	8"	
180691	10601026	10"	
180692	10601226	12"	
180693	10601426	14"	

Round Wyes

Wye Branch



Part #	Mfg #	Size	Price
179121	78866	8" x 6" x 6"	

Stub Wye



Part #	Mfg #	Size	Price
179214	203S444	4" x 4" x 4"	
179122	203S543	5" x 4" x 3"	
179125	203S544	5" x 4" x 4"	
179123	203S553	5" x 5" x 3"	
179124	203S663	6" x 6" x 3"	
179120	203S866	8" x 6" x 6"	

Round Fittings

Galvanized Tees
Galv 90° Tee Joint



Part #	Size	Gauge	Price
011264	6"	24ga	
011265	7"	24ga	
011266	8"	24ga	
011258	10"	24ga	
011259	12"	24ga	
011260	14"	24ga	
011261	3"	26ga	
011262	4"	26ga	
011263	5"	26ga	

Galv Stub Wye



Part #	Size	Price
016711	8" x 6" x 6"	

Galv Water Heater Tee 45°

Part #	Size	Price
011290	5" x 4" x 3"	
041432	5" x 4" x 4"	
011291	5" x 5" x 3"	
011292	6" x 6" x 3"	

Galv Flue Tee - 45°



Part #	Size	Price
106625	4" x 4" x 4"	

Galvanized Wyes
Galv Wye Branch



Part #	Size	Price
017816	8" x 6" x 6"	

Ducts, Fittings & Accessories



Round Miscellaneous

Ducts, Fittings & Accessories

Dampers

44 Damper (Two Quad)

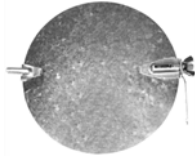

Part #	Mfg #	Size	Price
178926	448	8"	
178927	4410	10"	
178928	4412	12"	

44S Damper (Fixed Hardware)

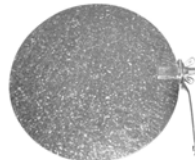

Part #	Mfg #	Size	Price
178921	44S4	4"	
178922	44S5	5"	
178923	44S6	6"	
178924	44S7	7"	
178925	44S8	8"	

40 Damper Section



Part #	Mfg #	Size	Price
179008	404	4"	
179009	406	6"	

Draw Bands

S75 Snap Drawband



Part #	Mfg #	Size	Price
180255	S755	5"	
180256	S756	6"	
180257	S757	7"	
180258	S758	8"	

96 Drawband (Gear Clamp)



Part #	Mfg #	Size	Price
178783	965	5"	
178784	966	6"	
178785	967	7"	

End Caps

55 End Cap

• Crimped



Part #	Mfg #	Size	Price
178912	554	4"	
178913	555	5"	
178914	556	6"	
178915	557	7"	
178916	558	8"	
178917	559	9"	
178918	5510	10"	
178919	5512	12"	
181322	5514	14"	
178651	5516	16"	

55NC End Cap

• No Crimpe

Part #	Mfg #	Size	Price
178902	553NC	3"	
178903	554NC	4"	
178904	555NC	5"	
178905	556NC	6"	
178906	557NC	7"	
178907	558NC	8"	
178908	559NC	9"	
178909	5510NC	10"	
178910	5512NC	12"	
178911	5514NC	14"	



Round Miscellaneous

Fresh Air Intakes

36 Fresh Air Intake

- 1/4" Galvanized mesh cover



Part #	Mfg #	Size	Price
178653	364	4"	
178970	365	5"	
178971	366	6"	
178974	368	8"	

Reducers

58 3-Pc No Crimp Reducer



Part #	Mfg #	Size	Price
178943	5843	4" x 3"	
178944	5853	5" x 3"	
178945	5854	5" x 4"	
178946	5863	6" x 3"	
178947	5864	6" x 4"	
178948	5865	6" x 5"	
178949	5873	7" x 3"	
178950	5874	7" x 4"	
178951	5875	7" x 5"	
178952	5876	7" x 6"	
178953	5884	8" x 4"	
178954	5885	8" x 5"	
178956	5886	8" x 6"	
178957	5887	8" x 7"	
178958	5896	9" x 6"	
178959	5897	9" x 7"	
178960	5898	9" x 8"	
178961	58106	10" x 6"	
178962	58107	10" x 7"	
178963	58108	10" x 8"	
178964	58109	10" x 9"	
178965	58128	12" x 8"	
178966	581210	12" x 10"	
227738	58146	14" x 6"	
178967	581412	14" x 12"	

Saddles

207 90° Vent Saddle



Part #	Mfg #	Size	Price
179019	2073	3"	
179020	2074	4"	

208 45° Vent Saddle



Part #	Mfg #	Size	Price
179022	2083	3"	
179023	2084	4"	

Ducts, Fittings & Accessories

Round Fittings

Ducts, Fittings & Accessories

Galvanized Drawbands

Galv Snap Drawband

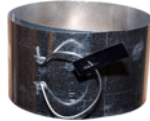

Part #	Size	Price
011160	6"	
011161	7"	

Galvanized End Caps



Galv Round End Cap

Part #	Size	Price
011054	4"	
011055	5"	
011056	6"	
011057	7"	
011058	8"	

Galv Round End Cap - Crimped

Part #	Size	Price
011063	4"	
011064	5"	
011065	6"	
011066	7"	
011067	8"	

Galv Round Cleanout End Cap

Part #	Size	Price
011053	3"	
011059	9"	
011050	10"	
011051	12"	
011052	14"	

Galv Round Cleanout End Cap - Crimped

Part #	Size	Price
011068	9"	
011060	10"	
011061	12"	

Galvanized Dampers

Galv Round Damper One Quad



Part #	Size	Price
011074	4"	
011075	5"	
011076	6"	
011077	7"	
011078	8"	

Galv Round Damper Two Quad



Part #	Size	Price
011072	10"	
011073	12"	

Galvanized Reducers

Galv Taper Reducer / No Crimp



Part #	Size	Price
010809	4" x 3"	
010810	5" x 3"	
010811	5" x 4"	
010812	6" x 3"	
010813	6" x 4"	
010814	6" x 5"	
010815	7" x 3"	
010816	7" x 4"	
010817	7" x 5"	
010818	7" x 6"	
010819	8" x 4"	
010820	8" x 5"	
010821	8" x 6"	
010822	8" x 7"	

Round Fittings

Galvanized Reducers (Continued)

Galv Taper Reducer / No Crimp

Part #	Size	Price
010823	9" x 6"	
010824	9" x 7"	
010825	9" x 8"	
010803	10" x 6"	
010804	10" x 7"	
010805	10" x 8"	
010806	10" x 9"	
055585	12" x 8"	
010807	12" x 10"	
010808	14" x 12"	

Galvanized Saddles

Galv 45° Saddle

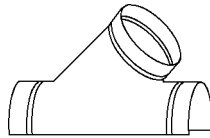

Part #	Size	Price
011185	3"	
011186	4"	

Galv 90° Saddle

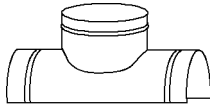

Part #	Size	Price
011183	3"	
011184	4"	

Ducts, Fittings & Accessories

Spiral Pipe & Fittings

Ducts, Fittings & Accessories

Spiral Pipe

26 Gauge SP10 Spiral Pipe

- 10 Foot lengths
- Galvanized steel
- Riveted connection
- Outside dimensions of each end diameter is approximately 1/8" under nominal size



Part #	Mfg #	Size	Price
179924	SP10426	4"	
179923	SP10526	5"	
179925	SP10626	6"	
179926	SP10726	7"	
179927	SP10826	8"	
179928	SP101026	10"	
179929	SP101226	12"	
179930	SP101426	14"	

24 Gauge SP10 Spiral Pipe

- 10 Foot lengths
- Galvanized steel
- Riveted connection
- Outside dimensions of each end diameter is approximately 1/8" under nominal size



Part #	Mfg #	Size	Price
179931	SP101624	16"	
179932	SP101824	18"	
179933	SP102024	20"	
179934	SP102224	22"	
179935	SP102424	24"	

Spiral Elbows

26 Gauge SP45 Spiral Angle

- Galvanized steel
- Riveted connection
- Outside dimensions of each end diameter is approximately 1/8" under nominal size



Part #	Mfg #	Size	Price
180080	SP45426	4"	
180081	SP45526	5"	
180082	SP45626	6"	
180083	SP45726	7"	
180084	SP45826	8"	
180085	SP451026	10"	

Spiral Elbows (Continued)

26 Gauge SP45 Spiral Angle

Part #	Mfg #	Size	Price
180086	SP451226	12"	

24 Gauge SP45 Spiral Angle

- Galvanized steel
- Riveted connection
- Outside dimensions of each end diameter is approximately 1/8" under nominal size



Part #	Mfg #	Size	Price
180087	SP451424	14"	
180088	SP451624	16"	
180089	SP451824	18"	
180090	SP452024	20"	
180091	SP452224	22"	
180092	SP452424	24"	

26 Gauge SP90 Spiral Elbow

- Galvanized steel
- Riveted connection
- Outside dimensions of each end diameter is approximately 1/8" under nominal size



Part #	Mfg #	Size	Price
180053	SP90426	4"	
180054	SP90526	5"	
180055	SP90626	6"	
180056	SP90726	7"	
180057	SP90826	8"	
180058	SP901026	10"	
180059	SP901226	12"	

24 Gauge SP90 Spiral Elbow

- Galvanized steel
- Riveted connection
- Outside dimensions of each end diameter is approximately 1/8" under nominal size



Part #	Mfg #	Size	Price
180060	SP901424	14"	
180061	SP901624	16"	

Spiral Pipe & Fittings

Spiral Elbows (Continued)

24 Gauge SP90 Spiral Elbow

Part #	Mfg #	Size	Price
180062	SP901824	18"	
180063	SP902024	20"	
180064	SP902224	22"	
180065	SP902424	24"	

26 Gauge SP90LR Long Radius Spiral Elbow

- Galvanized steel
- Riveted connection
- Outside dimensions of each end diameter is approximately 1/8" under nominal size



Part #	Mfg #	Size	Price
180066	SP90LR426	4"	
180067	SP90LR526	5"	
180068	SP90LR626	6"	
180069	SP90LR726	7"	
180070	SP90LR826	8"	
180071	SP90LR1026	10"	
180072	SP90LR1226	12"	

24 Gauge SP90LR Long Radius Spiral Elbow

- Galvanized steel
- Riveted connection
- Outside dimensions of each end diameter is approximately 1/8" under nominal size



Part #	Mfg #	Size	Price
180073	SP90LR1424	14"	
180074	SP90LR1624	16"	
180075	SP90LR1824	18"	
180076	SP90LR2024	20"	
180077	SP90LR2224	22"	
180078	SP90LR2424	24"	

Spiral Connectors

26 Gauge SPCON Spiral Connector

- Galvanized steel
- Riveted connection
- Outside dimensions of each end diameter is approximately 1/8" under nominal size



Part #	Mfg #	Size	Price
180093	SPCON426	4"	
180094	SPCON526	5"	
180095	SPCON626	6"	
180096	SPCON726	7"	
180097	SPCON826	8"	
180098	SPCON1026	10"	
180099	SPCON1226	12"	

24 Gauge SPCON Spiral Connector

- Galvanized steel
- Riveted connection
- Outside dimensions of each end diameter is approximately 1/8" under nominal size



Part #	Mfg #	Size	Price
180100	SPCON1424	14"	
180101	SPCON1624	16"	
180102	SPCON1824	18"	
180103	SPCON2024	20"	
180104	SPCON2224	22"	
180105	SPCON2424	24"	

Spiral Tees

26 Gauge SP54 Spiral Tee

- Galvanized steel
- Riveted connection
- Outside dimensions of each end diameter is approximately 1/8" under nominal size



Part #	Mfg #	Size	Price
180183	SP54444	4" x 4" x 4"	
180184	SP54554	5" x 5" x 4"	
180185	SP54555	5" x 5" x 5"	
180186	SP54664	6" x 6" x 4"	
180187	SP54666	6" x 6" x 6"	



Spiral Pipe & Fittings

Ducts, Fittings & Accessories

Spiral Tees (Continued)

26 Gauge SP54 Spiral Tee

Part #	Mfg #	Size	Price
180188	SP54774	7" x 7" x 4"	
180189	SP54776	7" x 7" x 6"	
180190	SP54777	7" x 7" x 7"	
180201	SP54884	8" x 8" x 4"	
180202	SP54886	8" x 8" x 6"	
180191	SP54888	8" x 8" x 8"	
180203	SP5410106	10" x 10" x 6"	
180204	SP5410108	10" x 10" x 8"	
180192	SP54101010	10" x 10" x 10"	
180205	SP5412126	12" x 12" x 6"	
180206	SP5412128	12" x 12" x 8"	
180207	SP54121210	12" x 12" x 10"	
180193	SP54121212	12" x 12" x 12"	

24 Gauge SP54 Spiral Tee

- Galvanized steel
- Riveted connection
- Outside dimensions of each end diameter is approximately 1/8" under nominal size



Part #	Mfg #	Size	Price
180208	SP5414146	14" x 14" x 6"	
180210	SP5414148	14" x 14" x 8"	
180211	SP54141410	14" x 14" x 10"	
180212	SP54141412	14" x 14" x 12"	
180194	SP54141414	14" x 14" x 14"	
180213	SP5416168	16" x 16" x 8"	
180214	SP54161610	16" x 16" x 10"	
180215	SP54161612	16" x 16" x 12"	
180216	SP54161614	16" x 16" x 14"	
180195	SP54161616	16" x 16" x 16"	
180217	SP54181810	18" x 18" x 10"	
180218	SP54181812	18" x 18" x 12"	
180219	SP54181814	18" x 18" x 14"	
180220	SP54181816	18" x 18" x 16"	
180196	SP54181818	18" x 18" x 18"	
180221	SP54202010	20" x 20" x 10"	
180222	SP54202012	20" x 20" x 12"	
180223	SP54202014	20" x 20" x 14"	
180224	SP54202016	20" x 20" x 16"	
180225	SP54202018	20" x 20" x 18"	

Spiral Tees (Continued)

24 Gauge SP54 Spiral Tee

Part #	Mfg #	Size	Price
180197	SP54202020	20" x 20" x 20"	
180226	SP54222218	22" x 22" x 18"	
180227	SP54222220	22" x 22" x 20"	
180198	SP54222222	22" x 22" x 22"	
180228	SP54242418	24" x 24" x 18"	
180230	SP54242420	24" x 24" x 20"	
180231	SP54242422	24" x 24" x 22"	
180199	SP54242424	24" x 24" x 24"	

Reducers

26 Gauge SP58 Spiral Tapered Reducer

- Galvanized steel
- Riveted connection
- Outside dimensions of each end diameter is approximately 1/8" under nominal size



Part #	Mfg #	Size	Price
179939	SP5854	5" x 4"	
179940	SP5864	6" x 4"	
179938	SP5865	6" x 5"	
179941	SP5874	7" x 4"	
179942	SP5875	7" x 5"	
179943	SP5876	7" x 6"	
179945	SP5885	8" x 5"	
179946	SP5886	8" x 6"	
179947	SP5887	8" x 7"	
179948	SP58106	10" x 6"	
179949	SP58107	10" x 7"	
179950	SP58108	10" x 8"	
179951	SP58126	12" x 6"	
179952	SP58128	12" x 8"	
179953	SP581210	12" x 10"	

24 Gauge SP58 Spiral Tapered Reducer

- Galvanized steel
- Riveted connection
- Outside dimensions of each end diameter is approximately 1/8" under nominal size



Part #	Mfg #	Size	Price
179955	SP581410	14" x 10"	
179956	SP581412	14" x 12"	
179954	SP58148	14" x 8"	

Spiral Pipe & Fittings

Reducers (Continued)

24 Gauge SP58 Spiral Tapered Reducer

Part #	Mfg #	Size	Price
179957	SP581610	16" x 10"	
179958	SP581612	16" x 12"	
179959	SP581614	16" x 14"	
179960	SP581812	18" x 12"	
179961	SP581814	18" x 14"	
179962	SP581816	18" x 16"	
179963	SP582014	20" x 14"	
179964	SP582016	20" x 16"	
179965	SP582018	20" x 18"	
179966	SP582216	22" x 16"	
179967	SP582218	22" x 18"	
179968	SP582220	22" x 20"	
179969	SP582418	24" x 18"	
179970	SP582420	24" x 20"	
179971	SP582422	24" x 22"	

26 Gauge SP58ER Spiral Eccentric Reducer

- Galvanized steel
- Riveted connection
- Outside dimensions of each end diameter is approximately 1/8" under nominal size



Part #	Mfg #	Size	Price
180129	SP58ER54	5" x 4"	
180130	SP58ER64	6" x 4"	
180131	SP58ER65	6" x 5"	
180132	SP58ER74	7" x 4"	
180133	SP58ER75	7" x 5"	
180134	SP58ER76	7" x 6"	
180135	SP58ER85	8" x 5"	
180136	SP58ER86	8" x 6"	
180137	SP58ER87	8" x 7"	
180138	SP58ER106	10" x 6"	
180139	SP58ER107	10" x 7"	
180140	SP58ER108	10" x 8"	
180141	SP58ER126	12" x 6"	
180142	SP58ER128	12" x 8"	
180143	SP58ER1210	12" x 10"	

24 Gauge SP58ER Spiral Eccentric Reducer

- Galvanized steel
- Riveted connection
- Outside dimensions of each end diameter is approximately 1/8" under nominal size



Part #	Mfg #	Size	Price
180145	SP58ER1410	14" x 10"	
180146	SP58ER1412	14" x 12"	
180144	SP58ER148	14" x 8"	
180147	SP58ER1610	16" x 10"	
180149	SP58ER1612	16" x 12"	
180150	SP58ER1614	16" x 14"	
180152	SP58ER1812	18" x 12"	
180153	SP58ER1814	18" x 14"	
180154	SP58ER1816	18" x 16"	
180155	SP58ER2014	20" x 14"	
180156	SP58ER2016	20" x 16"	
180157	SP58ER2018	20" x 18"	
180158	SP58ER2216	22" x 16"	
180159	SP58ER2218	22" x 18"	
180160	SP58ER2220	22" x 20"	
180161	SP58ER2418	24" x 18"	
180162	SP58ER2420	24" x 20"	
180163	SP58ER2422	24" x 22"	

Caps

26 Gauge SP55 Spiral End Cap

- Galvanized steel
- Riveted connection
- Outside dimensions of each end diameter is approximately 1/8" under nominal size



Part #	Mfg #	Size	Price
180106	SP554	4"	
180107	SP555	5"	
180108	SP556	6"	
180109	SP557	7"	
180110	SP558	8"	
180111	SP5510	10"	
180112	SP5512	12"	

Spiral Pipe & Fittings

Ducts, Fittings & Accessories

24 Gauge SP55 Spiral End Cap

- Galvanized steel
- Riveted connection
- Outside dimensions of each end diameter is approximately 1/8" under nominal size



Part #	Mfg #	Size	Price
180113	SP5514	14"	
180114	SP5516	16"	
180115	SP5518	18"	
180116	SP5520	20"	
180117	SP5522	22"	
180118	SP5524	24"	

Spiral Saddles

SP70 Spiral Register Saddle

- Galvanized steel
- Riveted connection
- Outside dimensions of each end diameter is approximately 1/8" under nominal size



Part #	Mfg #	Size	Price
180389	SP702106	2-1/4" x 10" 6"	
180310	SP702108	2-1/4" x 10" 8"	
180311	SP7021010	2-1/4" x 10" 10"	
180312	SP7021012	2-1/4" x 10" 12"	
180313	SP7021014	2-1/4" x 10" 14"	
180314	SP7021016	2-1/4" x 10" 16"	
180315	SP7021018	2-1/4" x 10" 18"	
180316	SP7021020	2-1/4" x 10" 20"	
180391	SP702126	2-1/4" x 12" 6"	
180318	SP702128	2-1/4" x 12" 8"	
180320	SP7021210	2-1/4" x 12" 10"	
180321	SP7021212	2-1/4" x 12" 12"	
180322	SP7021214	2-1/4" x 12" 14"	
180323	SP7021216	2-1/4" x 12" 16"	
180325	SP7021218	2-1/4" x 12" 18"	
180326	SP7021220	2-1/4" x 12" 20"	
180392	SP702146	2-1/4" x 14" 6"	
180327	SP702148	2-1/4" x 14" 8"	
180328	SP7021410	2-1/4" x 14" 10"	
180329	SP7021412	2-1/4" x 14" 12"	
180330	SP7021414	2-1/4" x 14" 14"	
180331	SP7021416	2-1/4" x 14" 16"	
180332	SP7021418	2-1/4" x 14" 18"	
180333	SP7021420	2-1/4" x 14" 20"	

Spiral Saddles (Continued)

SP70 Spiral Register Saddle

Part #	Mfg #	Size	Price
180393	SP704106	4" x 10" 6"	
180336	SP704108	4" x 10" 8"	
180337	SP7041010	4" x 10" 10"	
180338	SP7041012	4" x 10" 12"	
180339	SP7041014	4" x 10" 14"	
180340	SP7041016	4" x 10" 16"	
180342	SP7041018	4" x 10" 18"	
180343	SP7041020	4" x 10" 20"	
180395	SP704126	4" x 12" 6"	
180344	SP704128	4" x 12" 8"	
180345	SP7041210	4" x 12" 10"	
180346	SP7041212	4" x 12" 12"	
180347	SP7041214	4" x 12" 14"	
180348	SP7041216	4" x 12" 16"	
180349	SP7041218	4" x 12" 18"	
180350	SP7041220	4" x 12" 20"	
180396	SP704146	4" x 14" 6"	
180352	SP704148	4" x 14" 8"	
180353	SP7041410	4" x 14" 10"	
180354	SP7041412	4" x 14" 12"	
180355	SP7041414	4" x 14" 14"	
180356	SP7041416	4" x 14" 16"	
180357	SP7041418	4" x 14" 18"	
180358	SP7041420	4" x 14" 20"	
180397	SP706106	6" x 10" 6"	
180359	SP706108	6" x 10" 8"	
180360	SP7061010	6" x 10" 10"	
180361	SP7061012	6" x 10" 12"	
180362	SP7061014	6" x 10" 14"	
180363	SP7061016	6" x 10" 16"	
180364	SP7061018	6" x 10" 18"	
180365	SP7061020	6" x 10" 20"	
180399	SP706126	6" x 12" 6"	
180366	SP706128	6" x 12" 8"	
180367	SP7061210	6" x 12" 10"	
180368	SP7061212	6" x 12" 12"	
180369	SP7061214	6" x 12" 14"	
180370	SP7061216	6" x 12" 16"	
180371	SP7061218	6" x 12" 18"	
180372	SP7061220	6" x 12" 20"	
180381	SP706146	6" x 14" 6"	
180373	SP706148	6" x 14" 8"	
180374	SP7061410	6" x 14" 10"	
180375	SP7061412	6" x 14" 12"	



Spiral Pipe & Fittings

Spiral Saddles (Continued)

SP70 Spiral Register Saddle

Part #	Mfg #	Size	Price
180376	SP7061414	6" x 14" 14"	
180377	SP7061416	6" x 14" 16"	
180378	SP7061418	6" x 14" 18"	
180379	SP7061420	6" x 14" 20"	

Shoe Taps

SP 6 Spiral 90° Shoe Tap

- Galvanized steel
- Riveted connection
- Outside dimensions of each end diameter is approximately 1/8" under nominal size



		Size	Pipe Size
180414	SP606	6"	6"-10"
180415	SP606A	6"	12"-16"
180416	SP608	8"	8"-12"
180417	SP608A	8"	14"-18"
180418	SP610	10"	10"-14"
180419	SP610A	10"	16"-20"
180420	SP612	12"	12"-16"
180421	SP612A	12"	18"-22"



Wall Stack Duct

Ducts, Fittings & Accessories

Wallstacks

WSJ Wall Stack

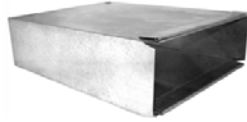

24" Joint

Part #	Mfg #	Size	Price
179167	WSJ24210	2-1/4" x 10"	
179168	WSJ24212	2-1/4" x 12"	
179169	WSJ24214	2-1/4" x 14"	
179170	WSJ24310	3-1/4" x 10"	
179171	WSJ24312	3-1/4" x 12"	
179172	WSJ24314	3-1/4" x 14"	

60" Joint

Part #	Mfg #	Size	Price
179164	WSJ60212	2-1/4" x 12"	
179165	WSJ60310	3-1/4" x 10"	
179166	WSJ60312	3-1/4" x 12"	

100" Joint

Part #	Mfg #	Size	Price
179160	WSJ100210	2-1/4" x 10"	
179161	WSJ100212	2-1/4" x 12"	
179162	WSJ100310	3-1/4" x 10"	
179163	WSJ100312	3-1/4" x 12"	

Wall Stack Duct

Galvanized Wall Stacks



Galv 24" Wall Stack

Part #	Size	Price
011113	2-1/4" x 10"	
011115	2-1/4" x 12"	
011119	3-1/4" x 10"	
011121	3-1/4" x 12"	
011123	3-1/4" x 14"	

Galv 60" Wall Stack

Part #	Size	Price
011116	2-1/4" x 12"	
011120	3 1/4" x 10"	
011122	3 1/4" x 12"	

Galv 100" Wall Stack

Part #	Size	Price
011114	2-1/4" x 12"	
011118	3-1/4" x 10"	
017815	3-1/4" x 12"	

Ducts, Fittings & Accessories

Wall Stack Fittings

Ducts, Fittings & Accessories

Elbows

WS14 90° Flat Stack Elbow (Broadway, Longway)



Part #	Mfg #	Size	Price
178940	WS14212	2-1/4" x 12"	
178941	WS14310	3-1/4" x 10"	
178942	WS14312	3-1/4" x 12"	

WS15 45° Vertical Stack Angle (Shortway)



Part #	Mfg #	Size	Price
178935	WS15210	2-1/4" x 10"	
178936	WS15212	2-1/4" x 12"	
178937	WS15310	3-1/4" x 10"	
178938	WS15312	3-1/4" x 12"	
178939	WS15314	3-1/4" x 14"	

WS16 90° Vertical Stack Elbow (Shortway)



Part #	Mfg #	Size	Price
178929	WS16210	2-1/4" x 10"	
178931	WS16212	2-1/4" x 12"	
178932	WS16310	3-1/4" x 10"	
178933	WS16312	3-1/4" x 12"	
178934	WS16314	3-1/4" x 14"	

Stack Boots

24 90° Stack Boot



Part #	Mfg #	Size	Price
178984	242106	2-1/4" x 10" x 6"	
178985	242126	2-1/4" x 12" x 6"	
178986	243106	3-1/4" x 10" x 6"	
178987	243126	3-1/4" x 12" x 6"	
178988	243127	3-1/4" x 12" x 7"	
178989	243148	3-1/4" x 14" x 8"	

27 Straight Stack Boot



Part #	Mfg #	Size	Price
179189	272106	2-1/4" x 10" x 6"	
178979	272126	2-1/4" x 12" x 6"	
178980	273106	3-1/4" x 10" x 6"	
178981	273107	3-1/4" x 10" x 7"	
178982	273126	3-1/4" x 12" x 6"	
178983	273127	3-1/4" x 12" x 7"	
227724	273147	3-1/4" x 14" x 7"	

28 End Stack Boot



Part #	Mfg #	Size	Price
179190	282106	2-1/4" x 10" x 6"	
178990	282126	2-1/4" x 12" x 6"	
178991	283106	3-1/4" x 10" x 6"	
178992	283126	3-1/4" x 12" x 6"	
178993	283127	3-1/4" x 12" x 7"	

Wall Stack Fittings

Galvanized Wall Stack Fittings

Galv Horizontal 90° Longway Elbow

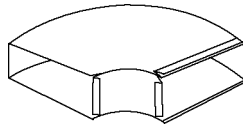

Part #	Size	Price
011092	2-1/4" x 12"	
011094	3-1/4" x 10"	
011093	3-1/4" x 12"	

Galv Vertical 45° Shortway Angle

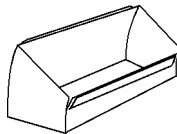

Part #	Size	Price
011087	2-1/4" x 12"	
011089	3-1/4" x 10"	
011090	3-1/4" x 12"	

Galv Vertical 90° Shortway Elbow

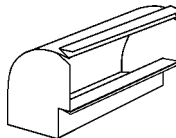

Part #	Size	Price
011081	2-1/4" x 10"	
011082	2-1/4" x 12"	
011084	3-1/4" x 10"	
011085	3-1/4" x 12"	
011086	3-1/4" x 14"	

Galv Straight Register Stackhead

Part #	Size	Price
011105	2-1/4" x 12"-6" x 12"	
011107	3-1/4" x 12"-6" x 12"	

Galvanized Stack Boots

Galv Straight Stack Boot



Part #	Size	Price
011126	2-1/4" x 12"-6"	
011127	3-1/4" x 10"-6"	
011129	3-1/4" x 12"-6"	
011130	3-1/4" x 12"-7"	

Galv Stack Boot 90° Elbow



Part #	Size	Price
011131	2-1/4" x 10"-6"	
011132	2-1/4" x 12"-6"	
011134	3-1/4" x 10"-6"	
011135	3-1/4" x 12"-6"	
011136	3-1/4" x 12"-7"	
030889	3-1/4" x 14"-8"	

Galv Stack Boot Center End



Part #	Size	Price
011139	3-1/4" x 10"-6"	

Fire Safety

AQUASAFE® Looped Fire Safety Systems

Flat Plate Concealed Sprinkler

- Threads onto stainless steel adapter fitting
- Includes protective cap and cup
- NSF & UL Approved



Part #	Mfg #	Description	Price
122574	Q74300BR	RFC43 Bronze 165°F Sprinkler	

Recessed Sprinkler Wrench



Part #	Mfg #	Description	Price
104041	Q7500200	Wrench for Recessed Sprinklers	

**ProPEX® LF Brass Fire Sprinkler Adapter
(PEX x PEX x FNPT)**

- Connects residential fire sprinklers to AQUAPEX tubing
- NSF and UL Approved for combining plumbing and fire sprinkler systems



Part #	Mfg #	Description	Price
132198	LF7707575	Adapter Tee, 3/4"x3/4"x1/2"	
134020	LF7701010	Adapter Tee, 1"x1"x1/2"	
133923	F7000005	Fire Sprinkler Adapter Push-On Nut, 25-Pack	

Fire Safety

Hydron Module

Geothermal Heat Pumps

- Rugged multi-position powder coated steel cabinet constructions with stainless steel accent panels
- All panels removable for easy service
- Bi-directional expansion valve
- Flow switch protected

Cold Climate VC Series Vertical Water-to-Air Heat Pumps

- Active display front panel with safety lockout
- Smart desuperheater with 3rd stage heat disable
- 100% front access
- High and low access ports
- TruBalance™ technology
- High efficiency Copland UltraTech® 2-stage scroll compressor
- ECM blower motor
- Desuperheater with internal pump
- 10/10/10/5 Limited residential warranty with free lifetime warranty upgrade option



Part #	Mfg #	Cooling Capacity	Cooling Cap BTUH*	Heating Cap BTUH*	Electrical	Hot Water Configuration	Price
172574	HVC036A11LT1CSS	3.0 Ton	34,700	37,200	208-230/60/1	Desuperheater	
172575	HVC048A11LT1CSS	4.0 Ton	46,800	43,300	208-230/60/1	Desuperheater	
172576	HVC060A11LT1CSS	5.0 Ton	51,100	52,500	208-230/60/1	Desuperheater	

Compact Vertical Single or Two-Stage Water-to-Air Heat Pump

- Single or two-stage scroll compressor
- All-aluminum microchannel air coil
- Sound and vibration absorbing compressor isolation pads
- Digital controls with enhanced unit protection
- Standard desuperheater (hot water generator)
- Standard PSC or optional ECM blower motor
- UL GREENGUARD certified foam cabinet insulation
- Heavy gauge steel cabinet with attractive painted finish
- Foam enclosed, enhance surface coaxial heat exchanger
- Meets ENERGY STAR requirements
- Hydron Module residential warranty coverage



Single Stage

Part #	Mfg #	Description	Price
173280	HVS018A11LT1CSS	1.5T 23,100 19,700 208-230/60/1 Desuperheater	
173281	HVS024A11LT1CSS	1.0T 28,100 24,200 208-230/60/1 Desuperheater	

Two-Stage

Part #	Mfg #	Description	Price
173398	HVT036A11LT1CSS	3.0T 40,000 36,900 208-230/60/1 Desuperheater	

Geothermal Equipment

Hydron Module

Evolution® HYT Series Multi-Position Geothermal Heat Pump

- Elastomeric compressor vibration absorption pads and high density close cell foam insulation make this one of the quietest units on the market
- Copeland's UltraTech® compressor
- The desuperheater captures waste heat during operation and transfers it into the domestic hot water supply, providing free hot water and enhancing the operation of the unit
- All-aluminum microchannel air coil
- Foamed coaxial heat exchanger
- Variable speed blower



Part #	Mfg #	Cooling Capacity	Cooling Cap BTUH*	Heating Cap BTUH*	Electrical	Hot Water Configuration	Price
172571	HYT036A11MT1CSS	3.0 Ton	41,200	29,100	208/230-1-60	Desuperheater	
172572	HYT048A11MT1CSS	4.0 Ton	53,300	39,900	208/230-1-60	Desuperheater	
177574	HYT072A11MT1CSS	6.0 Ton	71,900	56,200	208/230-1-60	Desuperheater	

HC Series Water to Air R-22 Single Speed Geothermal Heat Pump

- Standard R-22 refrigerant
- Single-stage closed loop system
- Upflow and downflow
- Right or left return
- Multi-speed, direct drive fan

Part #	Mfg #	Cooling Capacity	Cooling Cap BTUH*	Heating Cap BTUH*	Electrical	Heat	Price
097757	HC24SWA1-0TL011	2.0 Ton	25,800	21,300	208/230-1-60	10kW	

Revolution® HCT Series Water-to-Air Geothermal Combination Heat Pump

- Provides forced air heating and cooling in addition to hydronic heat for radiant floors
- All aluminum micro-channel air coil
- Composite, silver-ion anti-microbial drain pan
- Copeland UltraTech, 2-stage scroll compressor
- Digital controls
- ECM Blower motor
- Condensate overflow sensor



Part #	Mfg #	Cooling Capacity	Cooling Cap BTUH*	Heating Cap BTUH*	Electrical	Hot Water Configuration	Price
141482	HCT036A11MM1CSS	3.0 Ton	38,600	28,600	208/230-1-60	Desuperheater	
141483	HCT048A11MM1CSS	4.0 Ton	49,000	38,000	208/230-1-60	Desuperheater	
141484	HCT060A11MM1CSS	5.0 Ton	61,300	46,500	208/230-1-60	Desuperheater	
141485	HCT072A11MM1CSS	6 Ton	70,500	55,900	208/230-1-60	Desuperheater	

Geothermal Equipment

Hydron Module

Revolution® HST Series Geothermal Heat Pump

- 2-Stage indoor split system
- Non-ozone depleting R-410A refrigerant
- ETL Certified to UL & CSA standards
- 10-Year limited residential warranty



Part #	Mfg #	Cooling Capacity	Cooling Cap BTUH*	Heating Cap BTUH*	Electrical	Hot Water Configuration	Price
145206	HST024A11AAACSS	2.0 Ton	24,900	18,600	208/230-1-60	Desuperheater	
145207	HST036A11AAACSS	3.0 Ton	38,000	28,400	208/230-1-60	Desuperheater	
145208	HST048A11AAACSS	4.0 Ton	48,600	35,900	208/230-1-60	Desuperheater	

*Capacity values are for full load operation

Revolution® HWT Series Geothermal Heat Pump

- 2-Stage water-to-water
- Fault retry to eliminate nuisance service calls
- ETL Certified to UL & CSA standards
- 10-Year limited residential warranty



Part #	Mfg #	Cooling Capacity	Cooling Cap BTUH*	Heating Cap BTUH*	Electrical	Hot Water Configuration	Price
131995	HWT026A11AAACSS	2.0 Ton	23,100	23,700	208/230-1-60	Desuperheater	
143888	HWT036B11AAACSS	3.0 Ton	39,100	36,100	208/230-1-60	Desuperheater	
143889	HWT048B11AAACSS	4.0 Ton	49,400	44,100	208/230-1-60	Desuperheater	
165116	HWT060C11AAANSS	5.0 Ton	57,800	53,200	208/230-1-60	Desuperheater	
132000	HWT092A11AAACSS	8.0 Ton	96,600	90,000	208/230-1-60	Desuperheater	

*Capacity values are for full load operation

Revolution® HWS Series Geothermal Heat Pump

- Copeland scroll compressor
- Front, top & rear access
- Electronic controls with safety lock out
- Thermostatic expansion valve
- High and low access ports
- Desuperheater with internal heat pump



Part #	Mfg #	Description	Price
177021	HWS036B11AAACSS	3.0 Ton 34,700 26,600 208/230-1-60 Desuperheater	
177019	HWS060B11AAACSS	5.0 Ton 62,700 53,000 208/230-1-60 Desuperheater	
177020	HWS072B11AAACSS	6.0 Ton 73,300 63,100 208/230-1-60 Desuperheater	
177018	HWS084B11AAACSS	7.0 Ton 83,600 74,200 208/230-1-60 Desuperheater	

Geothermal Equipment

Hydron Module

Revolution® HXT Series Geothermal Heat Pump

- 2-Stage multi-position vertical unit for ground loop or ground water applications
- Non-ozone depleting R-410A refrigerant
- Coated air coils for extended life
- ECM Blower motor
- Corrosion-proof stainless steel drain pan
- ETL Certified to UL & CSA standards
- AHRI Certified to ISO standards
- 10-Year limited residential warranty



Part #	Mfg #	Cooling Capacity	Cooling Cap BTUH*	Heating Cap BTUH*	Electrical	Hot Water Configuration	Price
140130	HXT024C11MM1CSS	2.0 Ton	27,200	19,800	208/230-1-60	Desuperheater	
134261	HXT036C11MM1CSS	3.0 Ton	38,900	29,200	208/230-1-60	Desuperheater	
129301	HXT048C11MM1CSS	4.0 Ton	49,000	38,200	208/230-1-60	Desuperheater	
129302	HXT060B11MM1CSS	5.0 Ton	63,000	47,700	208/230-1-60	Desuperheater	
129303	HXT072B11MM1CSS	6.0 Ton	71,100	55,900	208/230-1-60	Desuperheater	

*Capacity values are for full load operation

Air Handlers

MP Series Hydronic Air Handler

- Multi-position air patterns
- Variable speed fan motor with multiple speed taps
- Single coil for both chilled water and hot water
- Optimized for use with Hydron Module water-to-water heat pumps
- Corrosion-proof plastic drain pan with primary and secondary drain connections
- Copper sweat water connections
- Narrow width for small closet installations
- Slide-out blower assembly
- Electrical: 208/230-1-60
- 10-Year parts warranty
- 10-Year labor allowance



Part #	Mfg #	Size	Dimensions H x W x D	Price
132004	MPH048A1MM1SH	4.0 Ton	58.75" x 25" x 22"	
132005	MPH060A1MM1SH	5.0 Ton	58.75" x 25" x 22"	

Hydron Module

A-Coils

AC Series DX A-Coil

- *Uncased design for maximum flexibility*
- *Corrosion-proof plastic drain pan with primary and secondary drain connections*
- *Sweat refrigerant line set connections*
- *10-Year refrigerant circuit warranty*
- *10-Year labor allowance*



Part #	Mfg #	Size	Line Sets Liq, Suct	Dimensions H x W x D	Price
132020	ACD024ASH	2.0 Ton	3/8", 3/4"	18-1/2" x 16-5/8" x 19"	
132021	ACD036ASH	3.0 Ton	3/8", 7/8"	20" x 19-3/4" x 19"	
132022	ACD048ASH	4.0 Ton	3/8", 7/8"	20" x 23-3/4" x 19"	
132023	ACD060ASH	5.0 Ton	3/8", 7/8"	24" x 23" x 21-3/4"	



Geothermal Accessories

Hydron Geothermal Unit Filters

Part #	Mfg #	Size	Price
149446	ZLPSP23.75x29.75x1EXACT	23.75" x 29.75" x 1"	
149387	ZLPSP27.75x29.75x1EXACT	27.75" x 29.75" x 1"	
149447	ZLPSP27.75x31.75x1EXACT	27.75" x 31.75" x 1"	
149386	ZLPSP27.75x33.75x1EXACT	27.75" x 33.75" x 1"	
149448	ZLPSP27.75x35.75x1EXACT	27.75" x 35.75" x 1"	

Geothermal Supplies

Geothermal Accessories

Hose Kits

Hose Kit: AGHK5C

- 10' 1" Rubber hose
- Hose clamps
- (2) 1/4" P/T fittings
- (2) Double o-ring elbow w/ P/T ports x 1" hose barb
- (2) Double o-ring x 1" hose barb fittings
- (2) Foam elbows

Part #	Mfg #	Description	Price
176442	AGHK5C	1" Hose Kit Double O-Ring	

Hose Kit: AGHK5D

- 10' 1" Rubber hose
- Hose clamps
- (2) 1/4" P/T fittings
- (2) Double o-ring elbow w/ P/T ports x 1" hose barb
- (2) AGBA55 1" MPT x 1" barb fittings
- (2) Foam elbows

Part #	Mfg #	Description	Price
176441	AGHK5D	1" Hose Kit Double O-Ring	

Filters

Washable Filter

Part #	Mfg #	Description	Price
100790	54AF3628	36" x 28" Hydron 2000 Washable F/H042,048,050,060,072,048E,060E,072E	

Electrostatic Filter

Part #	Mfg #	Description	Price
135852	AEF2830A	Aef2830 28" x 30"-1" Electrostatic Filter	
130942	AEF2834A	28" x 34"-1" Electrostatic Filter	

Pressurized Flow Center

- Foam insulated cabinet stops condensation
- High impact polystyrene cabinet will not rust
- Fully assembled and leak tested

Part #	Mfg #	Description	Price
136101	AGFC1D	1-Pump w/Up26-99f	
136102	AGFC2D	2-Pump w/Up26-99f	

Geothermal Accessories

Auxiliary Heaters

- Single-piece design - no separately mounted control box
- Low voltage harness for direct connection to relay board
- Automatic high limit and auxiliary limit switches for over temperature protection
- Factory provided internal unit plenum allows easy installation
- Internal circuit breakers

Internal Auxiliary Heater for Use with Revolution HX Series Units

Part #	Mfg #	Description	Compatible with:	Price
130898	AHTR101B	10kW Internal Plenum Heater	1.5 - 6.0 Ton Vertical Units	
130899	AHTR151B	15kW Internal Plenum Heater	3.0 - 6.0 Ton Vertical Units	
130900	AHTR201B	20kW Internal Plenum Heater	3.5 - 6.0 Ton Vertical Units	

Internal Auxiliary Heater for Use with H Series Units

Part #	Mfg #	Description	Compatible with:	Price
111899	AHTR101A	10kW Internal Plenum Heater	1.5 - 6.0 Ton Vertical Units	
111900	AHTR151A	15kW Internal Plenum Heater	3.0 - 6.0 Ton Vertical Units	
111901	AHTR201A	20kW Internal Plenum Heater	3.5 - 6.0 Ton Vertical Units	

Internal Auxiliary Heater for Use with Evolution Series

Part #	Mfg #	Description	Compatible with:	Price
177581	AHTR051D	5kW Internal Plenum Heater		
177582	AHTR101D	10kW Internal Plenum Heater	1.5 - 6.0 Ton Vertical Units	
177583	AHTR151D	15kW Internal Plenum Heater	3.0 - 6.0 Ton Vertical Units	
177584	AHTR201D	20kW Internal Plenum Heater	3.5 - 6.0 Ton Vertical Units	

Storage Tanks

Part #	Mfg #	Description	Price
097519	52ST50	RST50 50 gal (was 52ST50)	
106989	52ST80	80 gal	
097518	RST30	30 gal	

Heat Pump Components

Part #	Mfg #	Description	Price
142067	AGHK5A	1" Hose Kit w/DbI O-Ring	
134262	AXDNFL01A	Downflow Kit	
148259	AP3036F	30" x 36" x 2" Poly Foam Pad	
133801	11430007001	7 Amp Breaker	

Pump Module

Part #	Mfg #	Description	Price
103198	50PK011	ABFC1A Hydron 1 Pmp Pump Module	
103199	50PK021	ABFC2A Hydron 2 Pmp Pump Module	

Geothermal Accessories

Grundfos Pumps

- 1/6 hp Recirculator pump with cast iron pump housing
- Built-in motor protection
- Stainless steel construction



Part #	Mfg #	Description	Price
126539	G2-2699	230V	
139024	G2-116F	230V	

Geothermal Accessories

Geothermal Supplies

Geothermal Flow Systems

QT Fully Enclosed Non-Pressurized Flow Center

- Removable lid for fast installation easy to fill, check flow rates and add antifreeze
- Air separation chamber continually performs purging function
- Foam insulation eliminates condensation
- Long life check valve
- Hanging handles for ease of handling and installation
- 34"H x 14-3/4"W x 7-1/2"D
- 1" Swivel (FPT) inlet/outlet
- 230/60/1, White cabinet
- Suffix:
 - M = Grundfos 26-116 pump
 - None = without pump
- 5-Year warranty



Part #	Mfg #	Description	Price
104061	1-230QFC	(1) 1/6 hp Pump, 230V	
130846	1-230QFC-M	(1) 1/6 hp Pump, 230V	
104062	2-230QFC	(2) 1/6 hp Pumps, 230V	
130845	2-230QFC-M	(2) 1/6 hp Pumps, 230V, 26-116 Pump	

EA Non-Pressurized Flow Center

- Constructed of stainless steel
- Install (2) heat pumps and connect to the loop field
- Special (2) circuit flow center designed for 6 to 10 ton split coils or total 28 gpm with 2 pumps on each each circuit for one common loop field
- Outlet: 1-1/4" FPT
- Inlet: 1-1/4" MPT
- Field assembly required



Part #	Mfg #	Description	Price
100570	2-1E-A-KFC-SS	(3) 1/6 hp Pumps, 22* gpm. 3.21A/230V	26-99
101424	2-2E-A-KFC-SS.16	(4) 1/6 hp Pumps, 28* gpm. 4.28A/230V	26-99

*Standard: IPT on Inlet Connection. Union can be special ordered. *For Max Flow Use Grundfos 116F-1.8 AMPS per pump. EXTRA for 116F Pumps EA

Flow Center Accessories

WF-400N Series In-Line Flowmeter

- Acrylic rod stock polished to clear-as-glass finish
- Easy to read scales screen printed on meter body
- Adapters reinforced with aluminum stress rings for added strength
- Viton o-ring seals



Part #	Mfg #	Description	Price
115304	F-41017LN-16	1.0 to 17 gpm, 1" FPT	

GT Flowmeter Tool

- Provides direct reading of system flow rate



Part #	Mfg #	Description	Price
055519	1-WFT17-A	17 gal with Case	

Hose Kit - Complete Installation

- Includes:
 - (2) PEVT666S
 - (2) SPE66
 - (2) RGSE10025
 - (2) RBHE1000
 - (12) WS13053
 - (2) N76-02
 - (1) BRC1PE6
 - 12' WH01-200



Part #	Mfg #	Description	Price
131431	FC-CHK-KIT1-125	Complete Installation Hose Kit	

Hose Kit

- Closed loop



Part #	Mfg #	Size	Price
106902	HK-3/4-1-12	3/4" x 1" x 12'	
097338	HK-1-12	1" x 12'	
098755	HK-1-114-10	1" x 1-1/4" x 10'	
099080	HK-1-114-12	1" x 1-1/4" x 12'	

Geothermal Accessories

Hose

Part #	Mfg #	Description	Price
122365	WH01-200	1" x 50' 200 psi Rubber Hose Only	
122366	WH0125-150	1-1/4" x 50' 150 psi Rubber Hose Only	

Parts

Adapter

- For polyethylene



Part #	Mfg #	Description	Price
098752	MSA45	3/4" MPT x 1" Swivel Nut	
098751	MSA55	1" MPT x 1" Swivel Nut	

Brass Barb Fitting

Part #	Mfg #	Description	Price
098750	RGSE-10725	3/4" MIP x 1" Barb Elbow with PT Port	
098749	RGSE-10025	1" MIP x 1" Barb Elbow with PT Port	
095402	BRC1PE6	1" Brass Barb x 1-1/4" Fusion Coupling	

Deflectors

Dryer Venting

Supurr-Vent® Louvered Vent Hood



Part #	Mfg #	Size	Color	Price
108462	HS6B	6"	Brown	

Specialty Vents/Hoods

Fresh Air Intake Vent

- Includes molded 1/4" plastic screen



Part #	Mfg #	Size	Color	Price
104250	HSM6B	6"	Brown	

Undereve® Vent

For Clothes Dryer or Bathroom Exhaust Venting

- Helps prevent cold air from entering the home
- Helps prevent birds from nesting in the vent and rodents from entering the home
- Designed to vent clothes dryer exhaust, bathroom exhaust and any other venting up to 5" in diameter
- Easy installation: assemble vent, connect duct to opening made in eave, attach Undereve® vent



Part #	Mfg #	Description	Price
045755	EVE/6	White Vent - Case/6	

Grilles & Registers

Ceiling Grilles & Registers

Ceiling Air Diffusers

Airtec™ Classic Air Diffuser - Standard

- 8" x 8" Diffuser assembly



81911



81914

Part #	Mfg #	Description	Price
043588	81911	Round Grille/Damper/Box	
038122	81914	4-Way Grille/Damper/Box	

Airtec™ Classic Air Diffuser - Small

- 6" x 6" Diffuser assembly



Part #	Mfg #	Description	Price
099312	MV360S	Round Grille/Damper/Box	

Ceiling Support Flanges

Rough-In Flange

- Designed for new construction
- RCF Flashing can be fastened to rough framing
- 3/8" Lip that drops below the ceiling



Part #	Mfg #	Description	Price
038125	81965	16" on Center Framing, 9-1/4" Hole	

Grilles & Registers

Ceiling Grilles & Registers

Ceiling Diffusers

90 Series Step Down Round Diffuser

- Ideal for residential and light commercial applications
- Steel construction
- Attractive concentric ring deflects air stream 360°
- Soft white



Part #	Mfg #	Size	Price
122593	9006	6"	
122594	9008	8"	
122646	9010	10"	
122647	9012	12"	

Ceiling Dampers

91 Series Round Bowtie Damper

- For use with 90 series diffusers
- Field installable bowtie damper with wound ring
- Mill finish

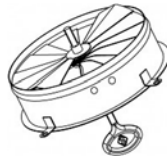

Part #	Mfg #	Size	Price
122595	9106	6"	
122597	9108	8"	
122649	9110	10"	
122650	9112	12"	

92 Series Round Ring

- Use in applications for installing round without damper
- Steel construction

Part #	Mfg #	Size	Price
122659	9206	6"	
122660	9208	8"	
123473	9210	10"	
122661	9212	12"	

Grilles & Registers

Ceiling Air Diffusers

Techgrille Diffuser

- Ceiling-mount
- Fully adjustable 6"



Part #	Mfg #	Description	Price
019281	EAG6CPU	Round, 6" Fully Adjustable	

Commercial Grilles & Registers

Commercial Grilles

106 FG Series T-Bar Fiberglass Back Filter Grille

- Return air T-Bar lay-in filter grille
- Removable louvered 20 gauge steel face
- 7/8" Fiberglass back plenum cut holes
- Seismic support holes
- Soft white



Part #	Mfg #	Size	Price
123390	106FG	20" x 20"	

111 Series T-Bar Fiberglass Back Grille

- Perforated face
- Seismic support hangers
- One size fits 6" - 16"

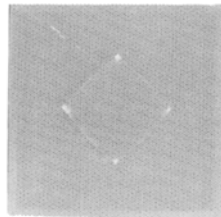

Part #	Mfg #	Size	Price
124378	111	24" x 24"	

Commercial Diffusers

600T Series Aluminum Lattice T-Bar Diffuser

- 1/2" x 1/2" x 1/2" Aluminum lattice return air T-Bar lay-in grille
- .055 T6 Extruded aluminum frame
- Square collar
- For 22" x 22" duct
- Soft white

Part #	Mfg #	Size	Price
126891	600T2424	24" x 24"	

601T Series Aluminum Lattice T-Bar Diffuser

- 1/2" x 1/2" x 1/2" Aluminum lattice return air T-Bar lay-in grille
- .055 T6 Extruded aluminum frame
- Fiberglass back (2" x 2" only, collar by others)
- For 22" x 22" duct
- Soft white

Part #	Mfg #	Size	Price
123571	601T2424	24" x 24"	

FTD Series Fixed T-Bar High Volume Diffuser

- Galvaneal steel face designed for high air volume delivery
- 360° Air diffusion
- No labor collar
- Seismic support hangers
- Soft white



Part #	Mfg #	Size	Price
123411	FTD6	24" x 24" x 6"	
123412	FTD8	24" x 24" x 8"	
123408	FTD10	24" x 24" x 10"	
123409	FTD12	24" x 24" x 12"	
123410	FTD14	24" x 24" x 14"	

FTD-INS Series Fixed T-Bar High Volume Diffuser

- Includes fiberglass backed plenum insulation
- Galvaneal steel face designed for high air volume delivery
- 360° Air diffusion
- No labor collar
- Seismic support hangers
- Soft white



Part #	Mfg #	Size	Price
123422	FTD-INS6	24" x 24" x 6"	
123423	FTD-INS8	24" x 24" x 8"	
123414	FTD-INS10	24" x 24" x 10"	
123419	FTD-INS12	24" x 24" x 12"	
123420	FTD-INS14	24" x 24" x 14"	

HVD Series 3-Cone T-Bar Diffuser

- Cones are 1-piece stamped construction providing a clean, smooth style
- 360° Air diffusion
- Excellent for variable air volume applications
- Hinged-down core for easy access
- No labor collar
- Seismic support hangers
- Soft white



Part #	Mfg #	Size	Price
141067	HVD6	24" x 24" x 6"	
140762	HVD8	24" x 24" x 8"	

Commercial Grilles & Registers

Commercial Dampers

BD Series Bowtie Damper

- For use with T-bars
- Field installable butterfly damper
- Mill finish



Part #	Mfg #	Size	Price
123406	BD-6	6"	
123407	BD-8	8"	
123403	BD-10	10"	
123404	BD-12	12"	
123405	BD-14	14"	

Grilles & Registers

Commercial Grilles & Registers

Ventilation Diffusers

Air Return Diffuser

- Egg crate lay-in louver
- White polystyrene 1/2" open cell grid

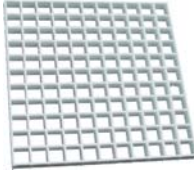

Part #	Mfg #	Size	Price
192724	650-100	2' x 4' x 1/2"	

Floor Grilles & Registers

Floor Grilles

1033 Series Return Air Grille

- 1/3" Spacing dual angular louvers
- 20 and 22 Gauge cold roll steel
- Install with louvers in up or down position for best duct concealment
- Countersunk mounting holes for flush appearance with color matching Phillips posi-drive screws

Part #	Mfg #	Size	Color	Price
123787	1033W1406	14" x 6"	White	
123788	1033W2406	24" x 6"	White	
123789	1033W3006	30" x 6"	White	
123790	1033W3008	30" x 8"	White	

1165 Series Triangular Baseboard Return Air Grille

- 1/2" Spacing dual angular louvers

Part #	Mfg #	Size	Color	Price
123238	1165W1406	14" x 6"	White	
123239	1165W2406	24" x 6"	White	
123240	1165W3006	30" x 6"	White	

1600 Series Floor Grille

- Steel honeycomb construction
- Flush core and frame provides smooth surface
- Free area equals more than 75% of nominal size
- Driftwood tan

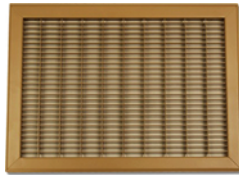

Part #	Mfg #	Size	Price
123675	16000424	4" x 24"	
122662	16000612	6" x 12"	
122663	16000614	6" x 14"	
122664	16000624	6" x 24"	
122665	16000630	6" x 30"	
122666	16000814	8" x 14"	
122667	16000824	8" x 24"	
122668	16001012	10" x 12"	
122670	16001214	12" x 14"	
123873	16001230	12" x 30"	
125839	16001420	14" x 20"	

1075 Series Heavy Duty Return Air Grille

- 1/2" Spacing dual angular louvers
- 20 and 22 Gauge cold roll steel
- Mullions are reinforced with stiffeners for greater strength
- For applications where greater air volume is required
- Install with louvers in up or down position for best duct concealment
- Countersunk mounting holes for flush appearance with color matching Phillips posi-drive screws
- Soft white



Part #	Mfg #	Size	Price
149124	10751204	12" x 4"	

1133 Series Baseboard Return Air Grille

- Stamped face
- 1/3" Spacing dual angular louvers

Part #	Mfg #	Size	Color	Price
124305	1133B1406	14" x 6"	Brown	
123791	1133W1406	14" x 6"	White	
123795	1133W3006	30" x 6"	White	

TD Series Toe Space Grille with Damper

- Formed cold roll steel
- Ideal for return air in the toe space areas between kitchen cabinets, stair risers, built-in vanities, etc
- Countersunk mounting holes for flush appearance with color matching Phillips posi-drive screws
- Multi-shutter damper



Part #	Mfg #	Size	Color	Price
123575	TD21412W	2-1/4" x 12"	White	

Floor Registers

855 Series Baseboard Register

- Stamped face
- Steel construction
- Fan shaped 1/2" spaced louvers
- Steel multi-shutter damper
- 7/8" Margin turnback
- All component parts, rivets, linkage and handle enclosed in valve to assure trouble-free operation
- Soft white

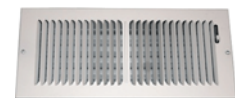

Part #	Mfg #	Size	Price
123569	8551206	12" x 6"	

Grilles & Registers

Floor Grilles & Registers

1550 Series Floor Register

- Mounting holes for sidewall and ceiling applications
- Steel honeycomb construction
- Flush core and frame provides smooth surface
- Free area equals more than 75% of nominal size
- Recessed, screwdriver-operated, opposed blade damper to control air volume for positive balance of system
- Positive volume set screw
- Driftwood tan



Part #	Mfg #	Size	Price
122636	15500612	6" x 12"	

Floor Diffusers (Continued)

350 Series Stamped Deluxe Floor Diffuser

Part #	Mfg #	Size	Color	Price
122943	35021412W	2-1/4" x 12"	White	
122944	35021414B	2-1/4" x 14"	Brown	
122945	35021414W	2-1/4" x 14"	White	
141396	3500414B	4" x 14"	Brown	
122951	3500414W	4" x 14"	White	

Floor Diffusers

325 Series Stamped Perimeter Floor Diffuser

- Cold rolled steel construction
- Opposed blade damper standard
- All component parts, rivets, linkage, and handle are enclosed in the valve to assure trouble-free operation
- Locking screw provision concealed beneath the floor for tamper proof settings
- Sold in carton quantity only



Part #	Mfg #	Size	Color	Price
123510	3250410B	4" x 10"	Brown	
123509	3250410W	4" x 10"	White	
123043	3250412B	4" x 12"	Brown	
123042	3250412W	4" x 12"	White	

350 Series Stamped Deluxe Floor Diffuser

- Heavy-gauge cold-rolled steel
- Louvers designed with rolled rib for maximum strength and rigidity
- Unique fan-shaped air patterns lends to both heating and air conditioning applications
- Opposed blade damper standard on 4" widths
- Parallel blade damper on 6" widths and larger
- All component parts, rivets, linkage, and handle are enclosed in the valve to assure trouble-free operation



Part #	Mfg #	Size	Color	Price
122941	35021410B	2-1/4" x 10"	Brown	
122940	35021410W	2-1/4" x 10"	White	
122942	35021412B	2-1/4" x 12"	Brown	

Grilles & Registers



Grille & Register Accessories

Accessories

Handle

Part #	Mfg #	Description	Price
130875	55	Bow-Tie Plastic Handle	

Screws and Bits

Part #	Mfg #	Description	Price
124653	C	8" x 2" Phillips Panhead Baseboard Screw	

Insulation

Part #	Mfg #	Description	Price
128739	FBP	Fiberglass Back Plenum	

Paint

Part #	Mfg #	Description	Price
136689	45	Driftwood Tan Spray Paint, 4.5 oz	

Sidewall Grilles & Registers

Sidewall Grilles

1050 Series Return Air Grille

- 1/2" Spacing dual angular louvers
- 20 and 22 Gauge cold roll steel
- Install with louvers in up or down position for best duct concealment
- Countersunk mounting holes for flush appearance with color matching Phillips posi-drive screws
- Soft white



Part #	Mfg #	Size	Price
123194	10501006	10" x 6"	
123195	10501008	10" x 8"	
123196	10501010	10" x 10"	
123197	10501206	12" x 6"	
123198	10501208	12" x 8"	
123199	10501212	12" x 12"	
123200	10501406	14" x 6"	
123201	10501408	14" x 8"	
123202	10501410	14" x 10"	
123203	10501412	14" x 12"	
123204	10501414	14" x 14"	
137588	10501606	16" x 6"	
127463	10501608	16" x 8"	
123205	10501616	16" x 16"	
123206	10502006	20" x 6"	
123207	10502008	20" x 8"	
123208	10502010	20" x 10"	
123209	10502012	20" x 12"	
123210	10502014	20" x 14"	
123211	10502016	20" x 16"	
123212	10502020	20" x 20"	
129115	10502024	20" x 24"	
123214	10502406	24" x 6"	
123215	10502408	24" x 8"	
123216	10502410	24" x 10"	
123217	10502412	24" x 12"	
123218	10502414	24" x 14"	
123219	10502416	24" x 16"	
123220	10502420	24" x 20"	
123221	10502424	24" x 24"	
123222	10503006	30" x 6"	
123223	10503008	30" x 8"	
123224	10503010	30" x 10"	
123225	10503012	30" x 12"	
132487	10503014	30" x 14"	

1150 Series Baseboard Return Air Grille

- Stamped face
- 1/2" Spacing dual angular louvers

Part #	Mfg #	Size	Color	Price
123229	1150W1206	12" x 6"	White	
123230	1150B1406	14" x 6"	Brown	
123232	1150W1406	14" x 6"	White	
129392	1150W1408	14" x 8"	White	
164097	1150B1408	14" x 8"	Brown	
123234	1150W2406	24" x 6"	White	
123236	1150B3006	30" x 6"	Brown	
123237	1150W3006	30" x 6"	White	
132412	1150W3008	30" x 8"	White	

TS Series Toe Space Grille

- Formed cold roll steel
- Ideal for return air in the toe space areas between kitchen cabinets, stair risers, built-in vanities, etc
- Countersunk mounting holes for flush appearance with color matching Phillips posi-drive screws



Part #	Mfg #	Size	Color	Price
122736	TS0210B	2" x 10"	Brown	
122591	TS0212B	2" x 12"	Brown	
122737	TS0212W	2" x 12"	White	
122740	TS0214B	2" x 14"	Brown	
122738	TS0214W	2" x 14"	White	
122592	TS0412W	4" x 12"	White	

FG2 Series Stamped Face 2" Filter Grille

- 1/2" Spacing dual angular louvers
- 20 and 22 Gauge cold roll steel
- Hand operated lever for easy filter access
- Holds up to 2" Filter (not included)
- Removable face for easy cleaning and maintenance
- Filter door hinges parallel to longest side
- 4-Way reversible door on square sizes
- 2-Way reversible door on rectangular sizes
- Filter retention tabs
- Concealed mounting holes
- Soft white



Part #	Mfg #	Size	Price
123382	FG21420	14" x 20"	
123383	FG21425	14" x 25"	

Grilles & Registers

Sidewall Grilles & Registers

Sidewall Grilles (Continued)

FG2 Series Stamped Face 2" Filter Grille

Part #	Mfg #	Size	Price
123380	FG21620	16" x 20"	
123384	FG21625	16" x 25"	
123385	FG22016	20" x 16"	
123386	FG22020	20" x 20"	
123387	FG22025	20" x 25"	
123388	FG22424	24" x 24"	
123389	FG22516	25" x 16"	
125075	FG22520	25" x 20"	

Sidewall Diffusers

850 Series Stamped 2-Way Diffuser

- Stamped 1/2" fan-shaped louvers for heating and cooling
- For ceiling or sidewall applications
- All component parts, rivets, linkage and handle are enclosed in the valve to assure trouble-free operation
- Countersunk mounting holes for flush appearance with color matching Phillips posi-drive screws
- Steel multi-shutter damper
- Soft white

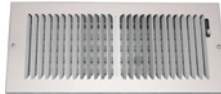

Part #	Mfg #	Size	Price
123392	8501004	10" x 4"	
123393	8501006	10" x 6"	
123394	8501204	12" x 4"	
123395	8501206	12" x 6"	
123396	8501208	12" x 8"	
123397	8501404	14" x 4"	
123398	8501406	14" x 6"	
123399	8501408	14" x 8"	
123400	8501608	16" x 8"	

875 Series Baseboard Diffuser

- Steel construction
- Generous free area for quiet operation
- Lever operated single-blade damper
- Removable face and damper
- Tension wings to stabilize damper



Part #	Mfg #	Size	Color	Price
122939	875B18	18"	Brown	
122938	875W18	18"	White	

951 Adjustable Steel Blade Diffuser

- Adjustable steel face blades with steel multi-shutter damper
- For ceiling or sidewall applications
- Vertical air deflectors with nylon bushings for easy adjustment and quiet settings
- Countersunk mounting holes for flush appearance with color matching Phillips posi-drive screws
- All component parts, rivets, linkage and handle are enclosed in the valve to assure trouble-free operation

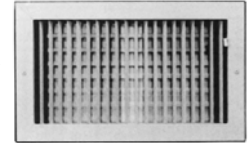

Part #	Mfg #	Size	Price
123028	9511004	10" x 4"	
123029	9511006	10" x 6"	
123030	9511204	12" x 4"	
123031	9511206	12" x 6"	
129734	9511404	14" x 4"	
123032	9511406	14" x 6"	
123033	9511408	14" x 8"	
141490	9511606	16" x 6"	
146924	9511608	16" x 8"	

Grilles & Registers



Sidewall Grilles & Registers

Sidewall Air Diffusers

Airtec™ Classic Air Diffuser - Small

- 6" x 6" Diffuser assembly



Part #	Mfg #	Description	Price
098602	MVES	Return/Exhaust Grille/Damper/Box	

Furnace Accessories

LP Conversion Kits

Part #	Mfg #	Description	Price
150450	904404A	LP Kit for G7 Furnaces	
143717	905028	LP Conversion Kit	

Furnace Accessories

Concentric Venting

Concentric Vent

- *Allows both the intake for combustion air and the exhaust vent to pass through a standard roof or sidewall*
- *Kit includes:*
 - *Combustion air inlet cap*
 - *Air inlet pipe*
 - *Vent pipe*
 - *Intake/vent concentric "Y"*
 - *Installation instructions on box*



Part #	Mfg #	Description	Price
138703	CVENT-2	For Use w/2" Intake/Vent Systems	
138704	CVENT-3	For Use w/3" Intake/Vent Systems	

Gas Fireplaces

Direct Vent Gas Fireplaces

Tahoe Deluxe Direct Vent Gas Fireplace

- Millivolt ignition with standing pilot/Piezo



Part #	Mfg #	Input BTUH	Gas Type	Ship Wt	Price
094560	DVD-36-FP30NG	20,000	NG	102 lbs	
094568	DVD-42-FP30NG	25,000	NG	121 lbs	

4" x 6-5/8" Direct Vent Kit

- Includes: cap, wall thimble, collars, gear clamps, vinyl siding shield, and 4' of 4" and 7" flexible vent

Part #	Mfg #	Description	Price
086619	DVVK-4F	DV Horiz Flexible Vent Kit	



Gas Downflow Furnaces

80% AFUE Downflow Gas Furnaces



- 80% Residential Gas Furnace CSA certified
- Downflow Design
- Single Stage Gas Valves
- PSC Blower Motors
- PlusOne™ Diagnostics 7-Segment LED
- Integrated control board
- Insulated blower compartment
- Heat Exchanger is removable
- PlusOne™ Ignition System - DSI for reliability
- Solid Door for Quiet Operation
- QR codes for quick access to product info from smart phone or tablet



Warranties

10-Yr Part Warranty

20 Year Heat Exchanger

PSC Premium Motor

Part #	Mfg #	Tons	Width	Input	Output	AFUE	Price
169610	R801PA050314ZSA	3 Ton	14"	50,000	40,000	80.0%	
169611	R801PA075317ZSA	3 Ton	17"	75,000	60,000	80.0%	
169613	R801PA100317ZSA	3 Ton	17"	100,000	80,000	80.0%	
169612	R801PA075417ZSA	4 Ton	17"	75,000	60,000	80.0%	
169614	R801PA100521ZSA	5 Ton	21"	100,000	80,000	80.0%	
169615	R801PA125524ZSA	5 Ton	24"	125,000	100,000	80.0%	
169616	R801PA150524ZSA	5 Ton	24"	150,000	120,000	80.0%	

PSC Standard Motor

Part #	Mfg #	Tons	Width	Input	Output	AFUE	Price
169599	R801SA050314ZSA	3 Ton	14"	50,000	40,000	80.0%	
169600	R801SA075317ZSA	3 Ton	17"	75,000	60,000	80.0%	
169601	R801SA075417ZSA	4 Ton	17"	75,000	60,000	80.0%	
169602	R801SA100421ZSA	4 Ton	21"	100,000	80,000	80.0%	
169603	R801SA125524ZSA	5 Ton	24"	125,000	100,000	80.0%	
169604	R801SA150524ZSA	5 Ton	24"	150,000	120,000	80.0%	

Heating - Forced Air

Gas Downflow Furnaces

Gas Downflow Furnaces

KG7S (K Series) 80% Gas Downflow Furnace

- 100% fired and tested
- Best packaging in the industry
- Low Boy Height
- Tubular primary heat exchanger
- 30 second blower delay at start-up
- 30 second post purge
- Hot surface ignitor
- Color coded wire harness
- High static blowers
- 90 second cooling cycle blower-off delay (TDR)
- Flexible category I venting system
- High efficiency blower kits:
- Multi-speed direct drive blower
- LP convertible
- Diagnostic lights for easy troubleshooting without counting flashes
- Integrated control board
- Two piece door design
- Furnace Air Leakage:



Part #	Mfg #	Tons	Motor Type	Input BTUH	Heating Capacity BTUH	Dimensions (H x W)	Price
118722	KG7SK054C23A	2-3	PSC	54,000	43,200	34 1/2" x 14 1/4"	
118723	KG7SK072C24B	2-4	PSC	72,000	57,600	34 1/2" x 17 1/2"	
118724	KG7SK090C24B	2-4	PSC	90,000	72,000	34 1/2" x 17 1/2"	
118725	KG7SK108C35C	3-5	PSC	108,000	86,400	34 1/2" x 21"	
118726	KG7SK126C45D	4-5	PSC	126,000	100,800	34 1/2" x 24 1/2"	

Gas Downflow Furnaces

KG7S (L Series) 92% Gas Downflow Furnace

- 100% fired and tested
- Best packaging in the industry
- 30 second blower delay
- 30 second post purge
- Hot surface igniter
- Color coded wire harness
- Flexible category IV venting system
- High Static Blowers
- Low Boy Height
- Tubular primary heat exchanger
- 90 second fixed cooling cycle blower-off delay (TDR)
- High efficiency blower kits
- Multi-speed direct drive blower
- LP convertible
- Diagnostic lights for easy troubleshooting without counting flashes
- Incorporates integrated control board
- Two piece door design enhances furnace appearance
- Seated vestibule
- Furnace Air Leakage.



Part #	Mfg #	Tons	Motor Type	Input BTUH	Heating Capacity BTUH	Dimensions (H x W)	Price
118732	KG7SL054D24B	2-3	PSC	54,000	49,700	34 1/2" x 17 1/2"	
118733	KG7SL072D24B	2-4	PSC	72,000	66,000	34 1/2" x 17 1/2"	
118734	KG7SL090D35C	3-5	PSC	90,000	82,800	34 1/2" x 21"	
118735	KG7SL120D45D	4-5	PSC	120,000	110,400	34 1/2" x 24 1/2"	

Heating - Forced Air

Gas Downflow Furnaces

KG7S (M Series) 95% Gas Downflow Furnaces

- 100% fired and tested
- Best packaging in the industry
- 30 second blower delay
- 30 second post purge
- Hot surface igniter
- Color coded wire harness
- Flexible category IV venting system
- High Static Blowers
- Low Boy Height
- Tubular primary heat exchanger
- 60 second fixed cooling cycle blower-off delay(TDR)
- High efficiency blower kits
- Multi-speed direct drive blower
- LP convertible
- Diagnostic lights for easy troubleshooting without counting flashes
- Incorporates integrated control board
- Two piece door design enhances furnace appearance
- Seated vestibule
- Furnace Air Leakage.



Part #	Mfg #	Tons	Motor Type	Input BTUH	Heating Capacity BTUH	Dimensions (H x W)	Price
143088	KG7SM054D24B	2-4	PSC	54,000	51,300	34 1/2" x 17 1/2"	
143087	KG7SM072D35C	3-5	PSC	72,000	68,000	34 1/2" x 21"	
143086	KG7SM090D35C	3-5	PSC	90,000	85,500	34 1/2" x 21"	
143085	KG7SM118D45D	4-5	PSC	118,000	112,100	34 1/2" x 24 1/2"	

Gas Downflow Furnaces

KG7T (L Series) 95% Gas Downflow Furnace

- 100% fired and tested
- Best packaging in the industry
- 30 second blower delay
- 30 second post purge
- Hot surface igniter
- Color coded wire harness
- Flexible category IV venting system
- High Static Blowers
- Low Boy Height
- Tubular primary heat exchanger
- 60 second fixed cooling cycle blower-off delay(TDR)
- High efficiency blower kits
- Multi-speed direct drive blower
- LP convertible
- Diagnostic lights for easy troubleshooting without counting flashes
- Incorporates integrated control board
- Two piece door design enhances furnace appearance
- Sealed vestibule
- Furnace Air Leakage.



Part #	Mfg #	Tons	Motor Type	Input BTUH	Heating Capacity BTUH	Dimensions (H x W)	Price
118736	KG7TL060D24B	2-4	BLDC	39,000	37,050	34 1/2" x 17 1/2"	
118737	KG7TL080D35C	3-5	BLDC	52,000	49,400	34 1/2" x 21"	
118738	KG7TL100D35C	3-5	BLDC	65,000	61,750	34 1/2" x 21"	
118739	KG7TL120D45D	4-5	BLDC	78,000	74,100	34 1/2" x 24 1/2"	

Gas Downflow-Horizontal Furnaces

92+ Residential Downflow Induced Draft Gas Furnaces - Direct or Non-Direct Vent High Efficiency, Condensing

- 100% Fired and tested, North American low Nox
- Clean and quiet operation
- Fixed 30-second blower delay and post purge
- Dependable, hot surface igniter
- Color coded wire harness
- Tubular primary heat exchanger
- Stainless steel secondary heat exchanger
- 90-Second fixed cooling cycle blower-off relay (TDR)
- Approved for direct vent furnace, Category IV venting system
- Variable speed blower kit
- Multi-speed direct drive blower
- LP Convertible
- Factory installed drain system
- Diagnostic light, 3 amp fuse protection
- Incorporates integrated control board
- Two-piece door design
- Low voltage terminal board
- 43"H x 28"D
- 10-Year parts & 10-year quality pledge warranty (product registration required)
- Limited lifetime warranty on heat exchanger (product registration required)



92+ AFUE - Downflow - Single-Stage - Condensing - High Efficiency - Fixed-Speed - KG7SC Series

Part #	Mfg #	Order #	Motor HP - Speed - Type	Input BTUH	Heating Capacity BTUH	Dimensions Width	Approx Ship Wt	Price
118733	KG7SL-072D-24B	904652K	1/2 - 4 - PSC	72,000	66,000	17-1/2"	125 lbs	

Heating - Forced Air

Gas Downflow-Horizontal Furnaces

95+ Residential Downflow Induced Draft Gas Furnaces - Direct or Non-Direct Vent High Efficiency, Condensing

- 100% Fired and tested, North American low Nox
- Clean and quiet operation
- Fixed 30-second blower delay and post purge
- Dependable, hot surface igniter
- Color coded wire harness
- Tubular primary heat exchanger
- Stainless steel secondary heat exchanger
- 90-Second fixed cooling cycle blower-off relay (TDR)
- Approved for direct vent furnace, Category IV venting system
- Variable speed blower kit
- Multi-speed direct drive blower
- LP Convertible
- Factory installed drain system
- Diagnostic light, 3 amp fuse protection
- Incorporates integrated control board
- Two-piece door design
- Low voltage terminal board
- 43"H x 28"D
- 10-Year parts & 10-year quality pledge warranty (product registration required)
- Limited lifetime warranty on heat exchanger (product registration required)



95+ AFUE - Downflow - Two-Stage - Condensing - High Efficiency - Fixed-Speed - KG7TC Series

Part #	Mfg #	Order #	Motor HP - Speed - Type	Input BTUH	Heating Capacity BTUH	Dimensions Width	Approx Ship Wt	Price
118739	KG7TL-120D-45D	904734K	1 - BLDC	120,000/78,000	114,000/74,100	24-1/2"	160 lbs	



Gas Multi-Position Furnaces



90+ Gas



- Up to 96% Residential Gas Furnace CSA certified
- 4 Way Multi-Position Design
- Single and Two Stage Gas Valves
- PSC and ECM Blower Motors
- PlusOne™ Diagnostics 7-Segment LED
- PlusOne™ Ignition System - DSI for reliability
- PlusOne™ Water management System

Warranties

10-Yr Part Warranty

Limite Lifetime Heat Exchanger

96% 2-Stage Gas Furnaces w/ PSC Motor

Part #	Mfg #	Tons	Width	Input	Output	AFUE	Price
159994	R96PA0402317MSA	3 Ton	17-1/2"	42,000	40,320	96.0%	
159995	R96PA0602317MSA	3 Ton	17-1/2"	56,000	53,760	96.0%	
159998	R96PA0702317MSA	3 Ton	17-1/2"	70,000	67,200	96.0%	
160001	R96PA0852521MSA	5 Ton	21"	84,000	80,460	95.0%	
160004	R96PA1002521MSA	5 Ton	21"	98,000	94,080	95.0%	
160007	R96PA1152524MSA	5 Ton	24-1/2"	112,000	107,520	96.0%	

95% Single Stage Gas Furnaces w/ X-13 Motor

Part #	Mfg #	Tons	Width	Input	Output	AFUE	Price
222224	R95TC0401317MSA	3 Ton	17-1/2"	42,000	40,320	95.0%	
222225	R95TC0601317MSA	3 Ton	17-1/2"	56,000	53,760	95.0%	
222226	R95TC0701317MSA	3 Ton	17-1/2"	70,000	67,200	95.0%	
222227	R95TC0851521MSA	5 Ton	21"	84,000	80,460	95.0%	
222228	R95TC1001521MSA	5 Ton	21"	98,000	94,080	95.0%	
222229	R95TC1151524MSA	5 Ton	24-1/2"	112,000	107,520	95.0%	

95% Single Stage Gas Furnaces w/ PSC Motor

Part #	Mfg #	Tons	Width	Input	Output	AFUE	Price
158565	R95PA0401317MSA	3 Ton	17-1/2"	42,000	40,320	95.0%	
158566	R95PA0601317MSA	3 Ton	17-1/2"	56,000	53,760	95.0%	
158567	R95PA0701317MSA	3 Ton	17-1/2"	70,000	67,200	95.0%	
158568	R95PA0851521MSA	5 Ton	21"	84,000	80,460	95.0%	
158569	R95PA1001521MSA	5 Ton	21"	98,000	94,080	95.0%	
158570	R95PA1151524MSA	5 Ton	24-1/2"	112,000	107,520	95.0%	

Heating - Forced Air



Gas Multi-Position Furnaces

92% Single Stage Gas Furnaces w/ PSC Motor

Part #	Mfg #	Tons	Width	Input	Output	AFUE	Price
158518	R92PA0401317MSA	3 Ton	17-1/2"	42,000	39,060	92.0%	
158519	R92PA0601317MSA	3 Ton	17-1/2"	56,000	52,080	92.0%	
158520	R92PA0701317MSA	3 Ton	17-1/2"	70,000	65,100	92.0%	
158521	R92PA0851521MSA	5 Ton	21"	84,000	78,120	92.0%	
158522	R92PA1001521MSA	5 Ton	21"	98,000	91,140	92.0%	
158523	R92PA1151524MSA	5 Ton	24-1/2"	112,000	104,160	92.0%	

Modulating Gas Furnaces

ULTRA

Series

- EcoNet™ Enabled
- ECM Motor
- Modulating Function: when used with an EcoNet Control
- PlusOne™ Ignition System
- PlusOne™ Water Management System
- PlusOne™ Diagnostics 7- Segment LED
- Blower Shelf design – serviceable in all furnace orientations
- Pre marked hoses – insures proper system drainage
- Vent with 2" or 3" PVC
- Integrated control boards feature dip switches for easy system set up
- Self priming condensate trap
- Solid bottom included



Warranties

Parts - 10 Years

Heat Exchanger - Limited Lifetime

Conditional Unit Replacement - Limited Lifetime

96% 2-Stage Variable Speed Gas Furnaces

Part #	Mfg #	Tons	Width	Input	Output	AFUE	Price
170931	U96VA0402317MSA	3 Ton	17-1/2"	42,000	40,320	96.0%	
160836	U96VA0602317MSA	3 Ton	17-1/2"	56,000	53,760	96.0%	
160837	U96VA0702317MSA	3 Ton	17-1/2"	70,000	67,200	96.0%	
160838	U96VA0852521MSA	5 Ton	21"	84,000	80,640	96.0%	
160839	U96VA1002521MSA	5 Ton	21"	98,000	94,080	96.0%	
160840	U96VA1152524MSA	5 Ton	24-1/2"	112,000	107,520	96.0%	

Heating - Forced Air



Gas Upflow/Horizontal Furnaces

80% Gas Furnaces

- 80% Residential Gas Furnace
- Upflow/Horizontal Design
- Single Stage Gas Valves
- PSC Blower Motors
- PlusOne™ Diagnostics 7-Segment LED
- PlusOne™ Ignition System - DSI for reliability
- Solid Door for Quiet Operation

ACHIEVER
series



Warranties

10-Yr Part Warranty

20 Year Heat Exchanger

80% Upflow/Horizontal Single Stage Gas Furnaces w/ PSC Motor Includes Insulated Blower Compartment and Solid Bottom

Part #	Mfg #	Tons	Width	Input	Output	AFUE	Price
169605	R801PA050314MSA	3 Ton	14"	50,000	40,000	80.0%	
185060	R801PA075317MSA	3 Ton	17"	75,000	60,000	80.0%	
169606	R801PA075417MSA	4 Ton	17"	75,000	60,000	80.0%	
180704	R801PA100417MSA	4 Ton	17"	100,000	80,000	80.0%	
169607	R801PA100521MSA	5 Ton	21"	100,000	80,000	80.0%	
169608	R801PA125524MSA	5 Ton	24"	125,000	100,000	80.0%	
169609	R801PA150524MSA	5 Ton	24"	150,000	120,000	80.0%	

80% Upflow/Horizontal Single Stage Gas Furnaces w/ PSC Motor Uninsulated Blower Compartment and Open Bottom

Part #	Mfg #	Tons	Width	Input	Output	AFUE	Price
169592	R801SA050314MSA	3 Ton	14"	50,000	41,000	80.0%	
185059	R801SA075317MSA	3 Ton	17"	75,000	61,000	80.0%	
169594	R801SA075417MSA	4 Ton	17"	75,000	61,000	80.0%	
180705	R801SA100417MSA	4 Ton	17"	100,000	82,000	80.0%	
169595	R801SA100521MSA	5 Ton	21"	100,000	81,000	80.0%	
169596	R801SA125524MSA	5 Ton	24"	125,000	101,000	80.0%	
169597	R801SA150524MSA	5 Ton	24"	150,000	122,000	80.0%	

Heating - Forced Air



Gas Upflow/Horizontal Furnaces

Modulating Gas Furnaces

ULTRA

Series

- EcoNet™ Enabled
- ECM Motor
- Modulating Function: when used with an EcoNet Control
- PlusOne™ Ignition System
- PlusOne™ Water Management System
- PlusOne™ Diagnostics 7- Segment LED
- Blower Shelf design – serviceable in all furnace orientations
- Pre marked hoses – insures proper system drainage
- Vent with 2" or 3" PVC
- Integrated control boards feature dip switches for easy system set up
- Self priming condensate trap
- Solid bottom included



Warranties

Parts - 10 Years

Heat Exchanger - Limited Lifetime

Conditional Unit Replacement - Limited Lifetime

97% Modulating Gas Furnaces

Part #	Mfg#	Blower	Width	Input	Output	AFUE	Price
185048	U97VA060M317USA	3 Ton	17-1/2"	56,000	54,320	97.0%	
185049	U97VA070M317USA	3 Ton	17-1/2"	70,000	67,900	97.0%	
185050	U97VA085M521USA	5 Ton	21"	84,000	81,480	97.0%	
185051	U97VA100M521USA	5 Ton	21"	98,000	95,060	97.0%	
185052	U97VA115M524USA	5 Ton	24-1/2"	112,000	408,640	97.0%	

Heating - Forced Air

Gas Upflow/Horizontal Furnaces

Gas Upflow Furnaces

KG7S (A Series) 80% Gas Upflow Furnace

- 100% fired and tested
- Best packaging in the industry
- Low Boy Height
- Tubular primary heat exchanger
- 30 second blower delay at start-up
- 30 second post purge
- Hot surface ignitor
- Color coded wire harness
- High static blowers
- 90 second cooling cycle blower-off delay (TDR)
- Flexible category I venting system
- High efficiency blower kits
- Multi-speed direct drive blower
- LP convertible
- Diagnostic lights for easy troubleshooting without counting flashes
- Integrated control board
- Two piece door design
- Furnace Air Leakage



Part #	Mfg #	Tons	Motor Type	Input BTUH	Heating Capacity BTUH	Dimensions (H x W)	Price
118713	KG7SA045C23A	2-3	PSC	45,000	36,000	34 1/2" x 14 1/4"	
118715	KG7SA054C23A	2-3	PSC	54,000	43,200	34 1/2" x 14 1/4"	
118716	KG7SA072C24B	2-4	PSC	72,000	57,600	34 1/2" x 17 1/2"	
118717	KG7SA090C24B	2-4	PSC	90,000	72,000	34 1/2" x 17 1/2"	
118718	KG7SA072C35C	3-5	PSC	72,000	57,600	34 1/2" x 21"	
118719	KG7SA090C35C	3-5	PSC	90,000	72,000	34 1/2" x 21"	
118720	KG7SA108C35C	3-5	PSC	108,000	86,400	34 1/2" x 21"	
118721	KG7SA126C45D	4-5	PSC	126,000	100,800	34 1/2" x 24 1/2"	

Gas Upflow/Horizontal Furnaces

KG7S (C Series) 92% Gas Upflow Furnace

- 100% fired and tested
- Best packaging in the industry
- Low Boy Height
- Tubular primary heat exchanger
- 30 second blower delay at start-up
- 30 second post purge
- Hot surface ignitor
- Color coded wire harness
- High static blowers
- 90 second cooling cycle blower-off delay (TDR)
- Flexible category I venting system
- High efficiency blower kits
- Multi-speed direct drive blower
- LP convertible
- Diagnostic lights for easy troubleshooting without counting flashes
- Integrated control board
- Two piece door design
- Furnace Air Leakage



Part #	Mfg #	Tons	Motor Type	Input BTUH	Heating Capacity BTUH	Dimensions (H x W)	Price
118758	KG7SC038D23A	2-3	PSC	38,000	35,000	34 1/2" x 14 1/4"	
118759	KG7SC054D24B	2-4	PSC	54,000	49,700	34 1/2" x 17 1/2"	
118760	KG7SC072D24B	2-4	PSC	72,000	66,000	34 1/2" x 17 1/2"	
118761	KG7SC090D35C	3-5	PSC	72,000	66,000	34 1/2" x 21"	
118762	KG7SC072D35C	3-5	PSC	90,000	82,800	34 1/2" x 21"	
118763	KG7SC108D45D	4-5	PSC	108,000	99,000	34 1/2" x 24 1/2"	
118764	KG7SC120D45D	4-5	PSC	120,000	110,400	34 1/2" x 24 1/2"	

Gas Upflow/Horizontal Furnaces

KG7T (C Series) 95% Gas Upflow Furnace

- 100% fired and tested
- Best packaging in the industry
- Low Boy Height
- Tubular primary heat exchanger
- 30 second blower delay at start-up
- 30 second post purge
- Hot surface ignitor
- Color coded wire harness
- High static blowers
- 90 second cooling cycle blower-off delay (TDR)
- Flexible category I venting system
- High efficiency blower kits
- Multi-speed direct drive blower
- LP convertible
- Diagnostic lights for easy troubleshooting without counting flashes
- Integrated control board
- Two piece door design
- Furnace Air Leakage



Part #	Mfg #	Tons	Motor Type	Input BTUH	Heating Capacity BTUH	Dimensions (H x W)	Price
118765	KG7TC060D24B	2-4	BLDC	60,000	57,000	34 1/2" x 17 1/2"	
118766	KG7TC080D35C	3-5	BLDC	80,000	76,000	34 1/2" x 21"	
118767	KG7TC100D35C	3-5	BLDC	100,000	95,000	34 1/2" x 21"	
118768	KG7TC120D45D	4-5	BLDC	120,000	78,000	34 1/2" x 24 1/2"	

Gas Upflow/Horizontal Furnaces

KG7S (D Series) 95% Gas Upflow Furnace

- 100% fired and tested
- Best packaging in the industry
- Low Boy Height
- Tubular primary heat exchanger
- 30 second blower delay at start-up
- 30 second post purge
- Hot surface ignitor
- Color coded wire harness
- High static blowers
- 90 second cooling cycle blower-off delay (TDR)
- Flexible category I venting system
- High efficiency blower kits
- Multi-speed direct drive blower
- LP convertible
- Diagnostic lights for easy troubleshooting without counting flashes
- Integrated control board
- Two piece door design
- Furnace Air Leakage



Part #	Mfg #	Tons	Motor Type	Input BTUH	Heating Capacity BTUH	Dimensions (H x W)	Price
143089	KG7SD038D24B	2-4	PSC	38,000	36,100	34 1/2" x 17 1/2"	
143091	KG7SD054D24B	2-4	PSC	54,000	51,300	34 1/2" x 17 1/2"	
143092	KG7SD072D35C	3-5	PSC	72,000	68,400	34 1/2" x 21"	
143093	KG7SD090D35C	3-5	PSC	90,000	85,500	34 1/2" x 21"	
143094	KG7SD108D45D	4-5	PSC	108,000	102,600	34 1/2" x 24 1/2"	
143095	KG7SD120D45D	4-5	PSC	120,000	114,000	34 1/2" x 24 1/2"	

Gas Upflow-Horizontal Furnaces

92+ Residential Induced Draft Gas Furnaces - Direct or Non-Direct Vent High Efficiency, Condensing

- 100% Fired and tested, North American low Nox
- Clean and quiet operation
- Fixed 30-second blower delay and post purge
- Dependable, hot surface igniter
- Color coded wire harness
- Tubular primary heat exchanger
- Stainless steel secondary heat exchanger
- 90-Second fixed cooling cycle blower-off relay (TDR)
- Approved for direct vent furnace, Category IV venting system
- Variable speed blower kit
- Multi-speed direct drive blower
- LP Convertible
- Factory installed drain system
- Diagnostic light, 3 amp fuse protection
- Incorporates integrated control board
- Two-piece door design
- Low voltage terminal board
- 43"H x 28"D
- 10-Year parts & 10-year quality pledge warranty (product registration required)
- Limited lifetime warranty on heat exchanger (product registration required)



92+ AFUE - Upflow/Horizontal - Single-Stage - Condensing - High Efficiency - Fixed-Speed - KG7SC Series

Part #	Mfg #	Order #	Motor HP - Speed - Type	Input BTUH	Heating Capacity BTUH	Dimensions Width	Approx Ship Wt	Price
118758	KG7SC-038D-23A	904639K	1/3 - 4 - PSC	38,000	45,000	14-1/4"	100 lbs	
118759	KG7SC-054D-24B	904640K	1/2 - 4 - PSC	54,000	49,700	17-1/2"	120 lbs	
118760	KG7SC-072D-24B	904641K	1/2 - 4 - PSC	72,000	66,000	17-1/2"	125 lbs	
118762	KG7SC-072D-35C	904642K	1/2 - 4 - PSC	72,000	66,000	21"	130 lbs	
118761	KG7SC-090D-35C	904643K	1.0 - 4 - PSC	90,000	82,800	21"	135 lbs	
118763	KG7SC-108D-45D	904644K	1.0 - 4 - PSC	108,000	99,000	24-1/2"	155 lbs	
118764	KG7SC-120D-45D	904645K	1.0 - 4 - PSC	120,000	110,400	24-1/2"	155 lbs	

Heating - Forced Air

Gas Upflow-Horizontal Furnaces

95+ Residential Induced Draft Gas Furnaces - Direct or Non-Direct Vent High Efficiency, Condensing

- 100% Fired and tested, North American low Nox
- Clean and quiet operation
- Fixed 30-second blower delay and post purge
- Dependable, hot surface igniter
- Color coded wire harness
- Tubular primary heat exchanger
- Stainless steel secondary heat exchanger
- 90-Second fixed cooling cycle blower-off relay (TDR)
- Approved for direct vent furnace, Category IV venting system
- Variable speed blower kit
- Multi-speed direct drive blower
- LP Convertible
- Factory installed drain system
- Diagnostic light, 3 amp fuse protection
- Incorporates integrated control board
- Two-piece door design
- Low voltage terminal board
- 43"H x 28"D
- 10-Year parts & 10-year quality pledge warranty (product registration required)
- Limited lifetime warranty on heat exchanger (product registration required)



95+ AFUE - Upflow/Horizontal - Single-Stage - Fixed-Speed - KG7SD Series

Part #	Mfg #	Order #	Motor HP - Speed - Type	Input BTUH	Heating Capacity BTUH	Dimensions Width	Approx Ship Wt	Price
143089	KG7SD-038D-24B	904990K	1/2 - 4 - PSC	38,000	36,100	17-1/2"	100 lbs	
143091	KG7SD-054D-24B	904991K	1/2 - 4 - PSC	54,000	51,300	17-1/2"	120 lbs	
143092	KG7SD-072D-35C	904993K	1/2 - 4 - PSC	72,000	68,400	21"	130 lbs	
143093	KG7SD-090D-35C	904994K	1 - 4 - PSC	90,000	85,500	21"	135 lbs	
143094	KG7SD-108D-45D	904995K	1 - 4 - PSC	108,000	102,600	24-1/2"	155 lbs	
143095	KG7SD-120D-45D	904996K	1 - 4 - PSC	120,000	114,000	24-1/2"	155 lbs	

95+ AFUE - Upflow/Horizontal - Two-Stage - Condensing - High Efficiency - Fixed-Speed - KG7TC Series

Part #	Mfg #	Order #	Motor HP - Speed - Type	Input BTUH	Heating Capacity BTUH	Dimensions Width	Approx Ship Wt	Price
118765	KG7TC-060D-24B	904727K	1/2 - BLDC	60,000/39,000	57,000/37,050	17-1/2"	125 lbs	
118766	KG7TC-080D-35C	904728K	3/4 - BLDC	80,000/52,000	76,000/49,400	21"	135 lbs	
118767	KG7TC-100D-35C	904729K	3/4 - BLDC	100,000/65,000	95,000/61,750	21"	145 lbs	
118768	KG7TC-120D-45D	904730K	1 - BLDC	120,000/78,000	114,000/74,100	24-1/2"	160 lbs	

Heating - Forced Air

Gas Upflow-Horizontal Furnaces

Residential Induced Draft Gas Furnaces

- 100% Fired and tested
- Clean and quiet operation
- Fixed 30-second blower delay and post purge
- Dependable, hot surface igniter
- Color coded wire harness
- Tubular primary heat exchanger
- 90-Second fixed cooling cycle blower-off relay (TDR)
- Approved for Category I and III venting systems
- Approved for use with 3" single wall AL29-4C stainless steel vent pipe in horizontal vent applications
- Multi-speed direct drive blower
- LP convertible
- Diagnostic lights, 3 amp fuse protection
- Integrated control board
- Two piece door design
- Low voltage terminal board
- 43"H x 27-5/8"D
- 10-Year parts & 10-year quality pledge warranty (product registration required)
- Limited lifetime warranty on heat exchanger (product registration required)



80+ AFUE Upflow/Horizontal - High Efficiency - Single-Stage - Fixed-Speed - KG7SA Series

Part #	Mfg #	Order #	Motor HP - Speed - Type	Input BTUH	Heating Capacity BTUH	Dimensions Width	Approx Ship Wt	Price
118713	KG7SA-045C-23A	904631K	1/3 - 4 - PSC	45,000	36,000	14-1/4"	100 lbs	
118715	KG7SA-054C-23A	904632K	1/3 - 4 - PSC	54,000	43,200	14-1/4"	100 lbs	
118716	KG7SA-072C-24B	904633K	1/2 - 4 - PSC	72,000	57,600	17-1/2"	110 lbs	
118718	KG7SA-072C-35C	904635K	1/2 - 4 - PSC	72,000	57,600	21"	115 lbs	
118717	KG7SA-090C-24B	904634K	1/2 - 4 - PSC	90,000	72,000	17-1/2"	115 lbs	
118719	KG7SA-090C-35C	904636K	1/2 - 4 - PSC	90,000	72,000	21"	120 lbs	
118720	KG7SA-108C-35C	904637K	3/4 - 4 - PSC	108,000	86,400	21"	125 lbs	
118721	KG7SA-126C-45D	904638K	3/4 - 4 - PSC	126,000	100,800	24-1/2"	145 lbs	

Heating - Forced Air

Gas Unit Heaters

Unit Heaters

UDAP V3® Power Vented, Low Static, Axial Fan Unit Heater

- All sizes are approved for commercial/industrial installations
- Sizes 30 - 125 are approved for residential application
- Rise range: 50° to 60°F
- Tcore2® Design titanium stabilized aluminized steel heat exchanger and single burner combustion system with 1-piece burner assembly
- 115-1-60 Supply voltage
- Internal overload protection
- Integrated circuit board with diagnostic indicator lights
- Fan relay
- Multi-try direct spark ignition with 100% lockout
- Full fan guard
- 2-Stage natural or propane gas valve on sizes 60 - 400



Part #	Mfg #	Gas Type	Input/ Output MBTUH	Efficiency	CFM	Vent Dia	Blower/ Fan Size	Dimensions H x W x D	Approx Ship Wt	Price
060544	UDAP30	NG	30/25	82%	456	4"	10"	12-1/8" x 25-5/8" x 26"	61 lbs	
060545	UDAP45	NG	45/37	83%	629	4"	10"	12-1/8" x 25-5/8" x 26"	66 lbs	
060546	UDAP60	NG	60/50	83%	769	4"	12"	15-1/8" x 25-5/8" x 27"	74 lbs	
099172	UDAP60AA2	LP	60/50	83%	769	4"	12"	15-1/8" x 25-5/8" x 27"	67 lbs	
060547	UDAP75	NG	75/62	83%	961	4"	12"	15-1/8" x 25-5/8" x 27-5/8"	79 lbs	
099171	UDAP75AA2	LP	75/62	83%	961	4"	12"	15-1/8" x 25-5/8" x 27-5/8"	79 lbs	
060548	UDAP100	NG	105/87	83%	1,345	4"	16"	23-1/8" x 25-5/8" x 28-5/8"	118 lbs	
060549	UDAP125	NG	120/100	83%	1,537	4"	16"	23-1/8" x 25-5/8" x 29-3/8"	123 lbs	
063749	UDAP150	NG	150/125	83%	1,921	5"	18"	20-1/8" x 38-3/16" x 42"	204 lbs	
063750	UDAP175	NG	175/145	83%	2,242	5"	18"	20-1/8" x 38-3/16" x 42"	219 lbs	
063751	UDAP200	NG	200/166	83%	2,562	5"	18"	20-1/8" x 38-3/16" x 42"	219 lbs	
063752	UDAP225	NG	225/187	83%	2,882	5"	18"	26-1/8" x 38-3/16" x 42"	245 lbs	
063753	UDAP250	NG	250/208	83%	3,202	5"	20"	26-1/8" x 38-3/16" x 42"	257 lbs	
063754	UDAP300	NG	300/249	83%	3,843	6"	24"	34-1/8" x 41 x 42"	321 lbs	
093423	UDAP400	NG	400/332	83%	5,123	6"	24"	34-1/8" x 41 x 42"	358 lbs	

Heating - Forced Air

Quiet-One Kickspace Heaters

Quiet-One 2000

Kickspace Heater

- 1-Piece chassis with removable grille manufactured from high grade zinc coated steel
- Headered coil made of copper tubes, tested at 300 psi and sealed for quality
- Integral 2-speed, max-off-min fan switches
- 120-60-1 Power supply is required
- Quiet efficient operation; installer friendly
- Easily fits in tight spaces or hard-to-heat areas



Part #	Mfg #	MBTUH	H x W x D	Price
122268	KS-2004	4.3	3-1/2" x 13-7/8" x 10-7/8"	
122273	KS-2008	8.9	3-13/16" x 20" x 10-7/8"	

Heating - Forced Air

Maxifold Manifolds & Accessories

Maxifold Manifolds



1-1/2" Stainless Steel Radiant Heating Manifold

- Includes:
 - Inline valves
 - Adjustable flowmeters - up to 2 gpm per loop
 - 1" Swt Manifold transitions
 - Mounting brackets

Part #	Mfg #	Description	Price
144240	H-4172	For 2 Branches	
144241	H-4173	For 3 Branches	
144242	H-4174	For 4 Branches	
144243	H-4175	For 5 Branches	
144244	H-4176	For 6 Branches	
144245	H-4177	For 7 Branches	
144246	H-4178	For 8 Branches	

Stainless Steel Extension Kit with Manifold Coupler

- Total number of loops not to exceed 14

Part #	Mfg #	Description	Price
144247	H-4172 EXT	For 2 Additional Branches	
144248	H-4173 EXT	For 3 Additional Branches	
144249	H-4174 EXT	For 4 Additional Branches	
144250	H-4175 EXT	For 5 Additional Branches	
144251	H-4176 EXT	For 6 Additional Branches	

Accessories

Part #	Mfg #	Description	Price
144253	H-4700	1" Full-Port Ball Valves (Set)	
144252	H-4004	Caps for Unused Loops	
144259	H-4900	Thermometer	
150018	H-6815	Manifold Gasket	

Electrothermal Actuator (LH)

- For heating manifolds and zone valves

Part #	Mfg #	Description	Price
144239	H-2496	Normally Closed with End Switch, 4-Wire	

Compression Fitting (EK20 Size)

- Use with manifolds, panel radiators, and towel warmers

Part #	Mfg #	Description	Price
145820	H-6848	5/16" PEX	
144254	H-6849	3/8" PEX	
144255	H-6850	1/2" PEX	
144256	H-6851	5/8" PEX	
144257	H-6852	3/4" PEX	

Boilers

Gas Combination Boilers

Condensing Gas Combination Boiler (NCB-E)

- Super condensing efficiency
- Dual stainless steel heat exchangers
- SCH40, 2" PVC venting up to 60'
- ½" Gas pipe up to 24'
- Automatic water filling system
- Integrated controls



Heating - Hydronic

Part #	Mfg #	Gas	Gas Supply Pressure Min - Max	Heat Capacity Input (MBTUH) Min - Max	Thermal Efficiency	DOE	Dimensions W x H x D	Approx Ship Wt	Price
181352	NCB-150E	NG/LP	3.5" - 10.5"WC	12,000-120,000	95%	28" x 17" x 12"	66lbs		
181353	NCB-180E	NG/LP	3.5" - 10.5"WC	14,000-150,000	95%	28" x 17" x 12"	74 lbs		
181354	NCB-210E	NG/LP	3.5" - 10.5"WC	18,000-180,000	95%	28" x 17" x 12"	84 lbs		
181356	NCB-240E	NG/LP	3.5" - 10.5"WC	18,000-199,000	95%	28" x 17" x 12"	84 lbs		

Gas Heating Boilers

Condensing Gas Boiler (NHB)

- Super condensing efficiency
- Dual stainless steel heat exchangers
- SCH40, 2" PVC venting up to 60'
- ½" Gas pipe up to 24'
- TDR 7:1 to 11:1
- integrated controls
- Natural gas supply pressure (from source): 3.5" x 10.5"wc
- Propane gas supply pressure (from source): 8.0"-13.5"wc



Part #	Mfg #	Gas	NG Manifold Pressure	LP Manifold Pressure	Gas Connection Size	Dimensions H x W x D	Ship Wt	Price
169617	NHB-55	NG/LP	3.5"-10.5"wc	8.0"-13.5"wc	3/4" NPT	24" x 17" x 12"	73 lbs	
169618	NHB-80	NG/LP	3.5"-10.5"wc	8.0"-13.5"wc	3/4" NPT	24" x 17" x 12"	73 lbs	
169619	NHB-110	NG/LP	3.5"-10.5"wc	8.0"-13.5"wc	3/4" NPT	24" x 17" x 13"	80 lbs	
169620	NHB-150	NG/LP	3.5"-10.5"wc	8.0"-13.5"wc	3/4" NPT	24" x 17" x 13"	80 lbs	

Rinnai Boilers

Condensing Wall-Mount Boilers

12-Year Heat Exchanger Warranty, 2-Year Parts Warranty, 1-Year on Labor Warranty

- 96.1% AFUE Rated
- Stainless steel and DHW plate heat exchanger
- 3-Way motorized valve allows boiler to switch between heating and DHW
- Energy Star® rated



Heating - Hydronic

Part #	Mfg #	Type of Gas	Input MBH	Htg MBH	Dimensions (H x W x D)	Wt	Price
143508	E110CN	NG	110,000 BTUH	101,000 BTUH	25.6" x 19.7" x 15.6"	101 lbs	
133319	Q85SN	NG	85,000 BTUH	78,000 BTUH	26.8" x 19.7" x 15.2"	110 lbs	
133322	Q130SN	NG	130,000 BTUH	119,000 BTUH	26.8" x 19.7" x 15.2"	117 lbs	
133337	Q175SN	NG	175,000 BTUH	161,000 BTUH	26.8" x 26" x 15.2"	141 lbs	
133327	Q205SN	NG	205,000 BTUH	189,000 BTUH	26.8" x 26" x 15.2"	141 lbs	

LP Conversion Kits for Boilers

Part #	Mfg #	Description	Price
143512	804000016	NG to LP Conversion Kit for E110C	
133330	804000017	NG to LP Conversion Kit for Q85S	
133331	804000018	NG to LP Conversion Kit for Q130S	
133338	804000019	NG to LP Conversion Kit for Q175S	
133333	804000020	NG to LP Conversion Kit for Q205S	
133332	804000021	NG to LP Conversion Kit for Q175C	

Thermolec Boilers

Electric Stand Alone, Modulating Boilers

Standard Features:

- **Mechanical:**
 - Heavy-duty, fully insulated heat generator
 - Low-watt density Incoloy elements
 - Easy access for installation and maintenance
 - Approved for zero clearance to combustible materials
 - Pressure relief valve
 - Temperature and pressure gauge
- **Electrical:**
 - Convenient plug-in electronic board controls all automatic functions
 - Pre-wired elements electronically controlled for full modulation
 - Quiet magnetic relays for heating elements and pump
 - High-limit thermal protection
 - Adjustable electronic hot water aqua-stat with wide range to suit all applications (80°F to 180°F)
 - Outdoor reset control saves energy and improves comfort
- **FFB Electric Boiler has the above features plus:**
 - Built-in, 2-position, dual fuel control switch allows manual selection of gas/oil or electric
 - Magnetic, diverting valve relay to divert from electric to fossil fuel back-up boiler
- **10-Year warranty on heat generator and Incoloy elements**



Heating - Hydronic

Part #	Mfg #	kW	Output BTUH	Total Amps	Breaker Size	Dimensions H x W x D	Weight	Price
121876	B-8U-FFB	8kW	27,296	33.33A	1 x 50A	18" x 18" x 9-1/2"	33 lbs	
121881	B-15U-FFB	15kW	51,180	62.50A	1 x 60A/1 x 30A	18" x 18" x 9-1/2"	37 lbs	
121883	B-20U-FFB	20kW	68,240	83.37A	2 x 60A	18" x 18" x 9-1/2"	42 lbs	
121884	B-23U-FFB	23kW	78,476	95.83A	2 x 60A	18" x 18" x 9-1/2"	42 lbs	
121886	B-30U-FFB	30kW	102,360	125.00A	3 x 60A	28" x 18" x 9-1/2"	59 lbs	
121888	B-40U-FFB	40kW	136,480	166.67A	4 x 60A	28" x 18" x 9-1/2"	62 lbs	

High Performance Electric Boilers

- Single or multiple-zone applications
- Requires no venting
- Sturdy aluminum case
- Stainless steel tank
- Compact and light weight design
- Aquastat control: adjustable supply water temperature range up to 190°F
- Full modulation for precise BTUH demand output
- Thermostat or zone valve end switch connections
- Pump switching relay
- Load management control connections
- Outdoor reset control
- Built-in circuit breaker
- Pressure relief valve: 30 psi
- Temperature and pressure gauge
- CSA Listed



Part #	Mfg #	kW	Output BTUH	Total Amps	Breaker Size	Dimensions H x W x D	Weight	Price
135153	B-6TMB	6kW	20,472	25.00A	1 x 40A	18" x 13" x 8-7/8"	23 lbs	
135156	B-11TMB	11kW	37,532	45.80A	1 x 60A	18" x 13" x 8-7/8"	27 lbs	

All boiler specifications @ 240V / 1-phase

Triangle Tube (Prestige) Boilers

Prestige Condensing Boilers

Prestige Excellence High Efficiency "Tank-in-Tank" Indirect-Fired Condensing Boiler

10-Year Limited Heat Exchanger Warranty

- 96% AFU Efficiency
- Abundant domestic hot water with standard mixing valve
- Highest water content in the industry
- Ideal for small zones without short cycling
- Self cleaning/self descaling
- Quiet operation
- Fully modulating
- Built-in exclusive "Tank-in-Tank"
- Unparalleled resistance to corrosion
- Less sensitive to water flow
- Vertical firetube design
- 439 Grade stainless steel heat exchanger
- Impervious to chloride cracking
- Stable temperature control
- Low pressure drop
- Condensate washes combustion residue away
- Control panel with digital display
- Standard outdoor reset
- Direct vent/sealed combustion



Heating - Hydronic

Part #	Mfg #	DOE Heat Capacity	Net IBR	MBH Input Modulation	Dimensions H x W x D	Water Volume	Gas Type	Ship Wt	Price
113080	PE110NG	99	86	30 - 110	37.2" x 24.7" x 20.8"	2.5 gal	NG	190 lbs	
113081	PE110LP	87	76	25 - 97	37.2" x 24.7" x 20.8"	2.5 gal	LP	190 lbs	

Prestige Solo Stainless Steel Wall Mount Condensing Boiler

Limited 10-Year warranty

- 95% High efficiency
- Quiet operation
- Fully modulating
- 439 Grade stainless steel heat exchanger
- Digital display
- High temperature limit protection
- Low water protection
- Low NOx
- Low pressure drop
- Self cleaning-condensate washes residue away
- Outdoor temperature sensor
- 30 psi Pressure relief valve



Part #	Mfg #	DOE Heat Capacity MBH	Net IBR	MBH Input Modulation	Dimensions H x W x D	Water Volume	Gas Type	Ship Wt	Price
113827	SOLO-60	54	47	16 - 60	35-1/2" x 20" x 16"	2.5 gal	NG	95 lbs	
091011	SOLO-110	99	86	30 - 110	35-1/2" x 20" x 16"	2.5 gal	NG	106 lbs	
091012	SOLO-110LP	87	76	25 - 97	35-1/2" x 20" x 16"	2.5 gal	LP	106 lbs	

Triangle Tube (Prestige) Boilers

Prestige Condensing Boilers (Continued)

Prestige Solo Stainless Steel Wall Mount Condensing Boiler

Part #	Mfg #	Doe Heat Capacity MBH	Net IBR	MBH Input Modulation	Dimensions H x W x D	Water Volume	Gas Type	Ship Wt	Price
091013	SOLO-175	154	134	50 - 170	35-1/2" x 20" x 16"	4.6 gal	NG	131 lbs	
102609	SOLO-250	223	194	65 - 245	35-1/2" x 20" x 16"	4.1 gal	NG	142 lbs	
107251	SOLO-399	379	330	112 - 399	37-1/2" x 24-3/4" x 20-3/4"	7 gal	NG	200 lbs	

Heating - Hydronic

Weil McLain Boilers

GV90+ Series High Efficiency Cast Iron Gas Boilers

- Insulated extended jacket
- Hot surface ignition system
- Cast iron primary heat exchanger
- Condensing stainless steel secondary heat exchanger
- Unique 7-pass heat exchanger design
- Vents with PVC
- Multiple vent options (direct vent, direct exhaust, concentric)
- Natural gas, easy conversion to propane (kit included)
- 3" Minimum vent size
- Down-fired, counter flow boiler design
- Built-in dual circulator
- Energy Star® rated
- 2-Year warranty on parts; 20-Year warranty on heat exchanger



Heating - Hydronic

Part #	Mfg #	Boiler Model	AGA Input BTUH	AFUE	DOE Heating Capacity BTUH	Net I=B=R Rating BTUH	Chimney/Vent Size	Approx Ship Wt	Price
143723	382-200-601	GV90+4	105,000	91.2%	97,000	84,000	3"	353 lbs	

EGH Atmospheric Gas Boilers

- Factory assembled section block
- Insulated extended jacket
- Horizontal to vertical draft hood
- Non-linting pilot burner
- Combination gas valve and regulator
- Aluminized steel burners
- 40VA Transformer
- Built-in Air separator
- Combination pressure-temperature gauge
- Steam boilers include:
 - 15 psi ASME Relief valve
 - High limit pressure control for PI with damper & PI models
 - Low water cut-off (electrode type)
 - Steam pressure gauge
 - Gauge cocks and glass
 - Siphon



EGH Atmospheric Gas Boiler - 24 Volt Intermittent Electronic Ignition Model - Natural Gas - Steam

Part #	Mfg #	Boiler Model	CSA Input BTUH	AFUE	DOE Heating Capacity BTUH	Net I=B=R Rating BTUH	AHRI Chimney/Vent Size	Approx Ship Wt	Price
063973	EGH-85-PIN	EGH-85-PIN	315,000	82.34%	243,000	182,000	9" ID	825 lbs	
063976	EGH-105-PIN	EGH-105-PIN	405,000	82.43%	312,000	234,000	10" ID	1,005 lbs	

Weil McLain Boilers

Ultra Series 3 - Condensing High-Efficiency Gas Boilers

- Factory tested
- Cast aluminum block
- 30 psi ASME Relief valve
- Drain valve
- Stainless steel burner with woven steel fiber mesh
- Direct spark ignition
- Variable speed blower assembly
- Gas/air ratio venturi with air silencer
- Negative pressure regulation gas valve
- 50VA Transformer
- Combination T&P gauge
- Outlet and return water temperature sensor
- Flue gas and outdoor temperature sensors
- Energy Star® rated



Heating - Hydronic

Ultra 3 Series - Natural Gas

Part #	Mfg #	Boiler Model	CSA Input BTUH	AFUE	DOE Heating Capacity BTUH	Net I=B=R Rating BTUH	Min Pipe Size	Approx Ship Wt	Price
116486	383-500-700	Ultra 80	80,000	95.2%	71,000	62,000	1"	199 lbs	

Ultra 3 Series - Propane Gas

Part #	Mfg #	Boiler Model	CSA Input MBH	AFUE	DOE Heating Capacity MBH	Net I=B=R Rating MBH	Min Pipe Size	Approx Ship Wt	Price
116487	383-500-701	Ultra 80	80,000	95.2%	71,000	62,000	1"	199 lbs	

Ultra 3 Series - Natural Gas & Field Convertible to Propane Gas

Part #	Mfg #	Boiler Model	CSA Input MBH	AFUE	DOE Heating Capacity MBH	Net I=B=R Rating MBH	Min Pipe Size	Approx Ship Wt	Price
116482	383-500-702	Ultra 105	105,000	95.3%	94,000	81,000	1"	207 lbs	
116483	383-500-703	Ultra 155	155,000	95.6%	139,000	123,000	1-1/4"	234 lbs	
116484	383-500-704	Ultra 230	230,000	95.4%	207,000	183,000	1-1/4"	246 lbs	
127438	383-500-705	Ultra 310	299,000	96.4%	270,000	234,000	1-1/2"	297 lbs	
127440	383-500-706	Ultra 399	399,000	91.7%	365,000	317,000	1-1/2"	297 lbs	

Weil McLain Boilers

Heating - Hydronic

Ultra Commercial Condensing High-Efficiency Gas Boilers with 20 - 100% Modulation

- Factory test report shipped with boiler
- Cast aluminum block
- CSD-1 Comes standard
- Manual reset low water cut-off
- Adjustable manual reset high limit
- Stainless steel burner with woven steel fiber mesh
- Venting with PVC or CPVC up to 100 feet
- Direct vent or direct exhaust capable
- Venturi mixing system with air silencer
- Variable speed motor
- Negative pressure regulation gas valve
- 50VA Transformer
- Integrated drain in vent adapters
- Outlet and inlet water temperature sensors
- Flue gas and outdoor temperature sensors



Part #	Mfg #	Boiler Model	CSA Input MBH	CSA Gross Output MBH	Net I=B=R Rating MBH	I=B=R Thermal Efficiency	Approx Ship Wt	Price
127626	383-600-010	550	550,000	517,000	445,000	93.9	505 lbs	
127627	383-600-011	750	750,000	702,000	605,000	93.6	550 lbs	

WM97+ Wall-Mount Gas Boilers

- Condensing stainless steel fire tube heat exchanger design
- Built in boiler circulator, primary/secondary piping option, low water cutoff and expansion tank
- Pre-wired terminal strip
- Indirect-fired water heater connection
- Capable to vent with PVC, PP and SS up to 100'
- Multi-color LCD display with text
- 3 Zone circulator control with optional domestic hot water priority
- 5 to 1 Turndown ratio capability
- Includes:
 - Propane conversion kit
 - Water treatment kit
 - Vent termination



Part #	Mfg #	Boiler Model	AGA Input BTUH	AFUE	DOE Heating Capacity BTUH	Net I=B=R Rating BTUH	Chimney/Vent Size	Approx Ship Wt	Price
144285	383-700-000	WM97+ 70	70,000	97%	65,000	57,000	3"	136 lbs	
144286	383-700-001	WM97+ 110	110,000	97%	101,000	88,000	3"	136 lbs	

Weil McLain Boilers

Evergreen Gas Boiler

- Stainless steel fire tube heat exchanger with non-metallic base
- Floor standing boiler with optional wall mount kit
- Sizes 220MBG, 299MBH, 399MBH
- Modulating condensing boiler with 10:1 turndown
- 95% AFUE (220/299); 96.5% combustion (399)
- 4 Pump/auxiliary outputs
- Up to 8 multiple boiler control with lead/lag rotation
- Modbus® to BMS connectivity
- Each input can be assigned to a priority (up to 3)
- Multiple inputs can be assigned on priority (zone base control)
- All lag boiler inputs and output can be used
- 0-10 Volt input (modulation or set point)
- Configurable auxiliary input/output system
- Boiler circulator included



Heating - Hydronic

Part #	Mfg #	Boiler Model	CSA Input MBH	AFUE	DOE Heating Capacity MBH	Net AHRI Rating MBH	Vent Size	Approx Ship Wt	Price
179790	383-900-000	EVG220	220	95%	206	179	3" or 4"	215 lbs	
179795	383-900-001	EVG299	299	95%	280	243	4"	260 lbs	
179797	383-900-002	EVG399	399	96.5%	383	333	4"	260 lbs	

Uponor (Wirsbo) Heating

Heating - Hydronic

TruFLOW™ Assembled Brass Manifolds

TruFLOW™ Assembled Without Flow/Temp Meter

- Comes fully assembled ready for installation
- The TruFLOW balancing Hex Key is used on the internal balancing valves of the supply manifold to balance the loops
- Manifold is shipped with the appropriate number of actuator adapters (A2630028)
- Maximum recommended flow to the manifold based on manifold body diameter is 21 gpm



Part #	Mfg #	Description	Price
074022	A2610200	2 Loop	
083039	A2610300	3 Loop	
074023	A2610400	4 Loop	
083429	A2610500	5 Loop	
079647	A2610600	6 Loop	
083428	A2610700	7 Loop	
079648	A2610800	8 Loop	
086861	A2611000	10 Loop	
086863	A2611200	12 Loop	

TruFLOW™ Brass Manifold Specific Accessories

TruFLOW™ Manifold Loop Thermometer

- Comes with R20 (QS-style) female union on one end and an R20 (QS-style) male on the other
- Thermometer well and removable thermometer are included



Use ONLY with Uponor TruFLOW Jr. and Classic Manifolds

Part #	Mfg #	Description	Price
081827	A2610020	TruFLOW Manifold Loop Thermometer	

TruFLOW™ Classic Flo with Temperature Meter

- R20 Male thread to connect with R20 threaded fitting assemblies
- Note: For proper operation, install Flo with Temperature Meters on the return manifold



Part #	Mfg #	Description	Price
079650	A2620027	0.37 - 2.0 gpm (Supplied on A2610000)	

TruFLOW™ Manifold Supply & Return Ball Valves with Thermometer

- Full-flow 1-1/4" ball valves with R32 male x R32 union nut that fits directly on TruFLOW manifold
- Standard with a thermometer



Use ONLY with Uponor TruFLOW Jr. and Classic Manifolds

Part #	Mfg #	Description	Price
084177	A2631250	Ball Valves Supply & Return	

TruFLOW™ Classic Manifold Extension Kit

- For easy in-line extension of up to two additional loops for the TruFLOW classic manifold assembly
- Contains (2) 1-1/4" BSP nipples, (1) supply manifold, (1) return manifold and (2) loop end caps



Part #	Mfg #	Description	Price
093249	A2610100	Classic Manifold Ext Kit, 2 Loops	

Heating Manifolds

EP Heating Manifold

- Includes isolation valve and balancing valve with flow meters
- Made of engineered plastic and fully assembled
- Body ends have R32 unions and loop outlets have R20 male threads
- Mounts on fully assembled bracket (A2670006)



Part #	Mfg #	Loops	Price
120254	A2670201	2	
120255	A2670301	3	
120256	A2670401	4	
120257	A2670501	5	
120258	A2670601	6	
120259	A2670701	7	
120260	A2670801	8	

Uponor (Wirsbo) Heating

EP Heating Manifold Accessories



Part #	Mfg #	Description	Price
124454	A2671300	Actuator Adapter	

1-1/4" Brass Manifold Accessories

End Cap with Vent

- For 1-1/4" brass manifolds
- Complete with swivel drain valve and manual air vent
- Required gasket included (A2403232)



Part #	Mfg #	Description	Price
011754	A2803250	End Cap with Vent, R32	

End Cap

- For 1-1/4" brass manifolds
- Required gasket included

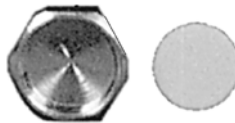

Part #	Mfg #	Description	Price
011753	A2080032	Basic End Cap, R32	
025646	A2080020	Loop End Cap, R20	

Manifold Accessories for TruFLOW™ and 1-1/4" Brass Manifolds

Copper Manifold Adapter

- Use sweat adapter to transition R32 manifold union nut to 3/4", 1", and 1-1/4" copper pipe, copper fittings and valves



Use with 1-1/4" Brass and TruFLOW Manifolds
Not compatible with TruFLOW Sr.

Part #	Mfg #	Description	Price
011764	A4143210	R32 x 3/4" or 1"	
011763	A4133210	R32 x 1" or 1-1/4"	

Manifold Threaded Adapter/Bushing

- Manifold Adapter for brass manifold transitions the R32 manifold union nut to PEX or MultiCor tubing with QS-style fittings



Use with 1-1/4" Brass and TruFLOW Manifolds
Not compatible with TruFLOW Sr.

Part #	Mfg #	Description	Price
011751	A2123210	R32 Male x 1" FNPT Bushing	

ProPEX® Manifold Adapter

- Use to transition from the R32 manifold union nut to 3/4" and 1" AQUAPEX® and hePEX™plus



Use with 1-1/4" Brass and TruFLOW Manifolds
Not compatible with TruFLOW Sr.

Part #	Mfg #	Description	Price
045201	Q4143210	R32 x 1" Straight	
099804	Q4153275	R32 x 3/4" Elbow	

Brass Manifold Pressure Test Kit

- Includes
 - R32 x 3/4" Manifold bushing
 - R32 Solid brass plug
 - 3/4" Brass nipple and pressure gauge assembly (100 psi)
 - Schraeder valve



Use with 1-1/4" Brass and TruFLOW Manifolds
Not compatible with TruFLOW Sr.

Part #	Mfg #	Description	Price
028958	E6122000	Pressure Test Kit	

Manifold Gasket

- Spare part
- For 1-1/4" manifold and manifold parts
- NOTE: Gaskets are not interchangeable between parts except as noted - to seal properly the correct gasket must be used



Part #	Mfg #	Description	Price
011755	A2403232	End Cap w/Vent Gasket	

Heating - Hydronic

Uponor (Wirsbo) Heating

Heating - Hydronic

TruFLOW Manifold Actuator Adapter

- M28 brass adapter converts the manifold actuator threads to fit the Uponor Thermal Actuator A3023522
- Use only with the TruFLOW Jr. and Classic Manifolds



Part #	Mfg #	Description	Price
110901	A2630028	Adapter Replacement Part	

Manifold Wall Cabinet

- Recessed-style
- 2x4 or 2x6 Stud wall



Part #	Mfg #	Description	Price
087014	A2603539	35.5"H x 39"W x 3.5"D	

Replacement and Spare Parts for Manifolds

Part #	Mfg #	Description	Price
163459	A2620005	Replacement Gasket for R32 Union Connections	
093251	A2620008	Replacement O-Ring for 1-1/4" BSP Connections	

Fitting Assemblies

QS-Style Fitting Assembly

- Compression fitting assembly with o-ring (sold separately)
- Connects 5/16", 1/2" and 5/8" Uponor hePEX plus and AQUAPEX tubing to all Uponor manifolds and R20 components PEX tubing to Uponor™ manifold outlets R20 components
- Sold as a 3-piece component



This fitting is not compatible with TruFLOW Sr.

Part #	Mfg #	Size	Type	Price
040687	A4020313	5/16"	R20 Thread	
022644	A4020500	1/2"	R20 Thread	
022645	A4020625	5/8"	R20 Thread	

ProPEX® Fitting Assembly (PEX to Brass)

- PEX Tubing to the brass manifolds
- Sold as a 2-piece assembly, it includes a ProPEX® insert and swivel nut
- ProPEX® tool and ProPEX® rings required (sold separately)



This fitting is not compatible with the TruFLOW Sr.

Part #	Mfg #	Size	Type	Price
045203	Q4020500	1/2"	R20 Thread	
045204	Q4020625	5/8"	R20 Thread	
087016	Q4020750	3/4"	R20 Thread	

QS Fitting Assembly O-Ring

Part #	Mfg #	Description	Price
025703	WIOR3812 58	O-Ring Replacement for R20 Thread	

MultiCor Compression Fitting Assemblies (MultiCor x Brass)

- Made of heat-treated brass, connects 1/2" and 5/8" MultiCor tubing to brass manifolds
- The 3/4" MultiCor Fitting Assembly has R25 threads and will not thread directly onto brass manifolds



This fitting is not compatible with the TruFLOW Sr.

Part #	Mfg #	Size	Type	Price
069715	D4120500	1/2"	R20 Thread	
069714	D4120625	5/8"	R20 Thread	

ProPEX Baseboard Elbow and Tee (PEX x CU)

- Connects 1/2", 5/8", and 3/4" Uponor PEX tubing products to 3/4" copper baseboard
- ProPEX tool is required



Part #	Mfg #	Description	Price
043564	Q4386375	5/8" x 3/4"	

MLC Press Fitting Brass Tee (MLC x MLC x MLC)

- Makes diverting connections for MLC tubing in supply and return mains
- Mini-Press Battery Tool or MLC Press Fitting Manual Tool is required



Part #	Mfg #	Description	Price
092804	D4701010	1" x 1" x 1"	

Uponor (Wirsbo) Heating

MLC Press Fitting Brass Elbow (MLC x MLC)

- Makes 90° connections for MLC tubing
- Mini-Press Battery Tool or MLC Press Fitting Manual Tool is required



Part #	Mfg #	Description	Price
092803	D4711000	1" x 1"	

MLC Press Fitting Adapter (MLC x NPT)

- Brass male MPT threaded adapter connects MLC tubing to male NPT threads
- Mini-Press Battery Tool or MLC Press Fitting Manual Tool is required



Part #	Mfg #	Description	Price
092805	D4521010	1" x 1"	

Tubing Transition Fittings

QS-Style Coupling Nipple (Thread x Thread)

- Use coupling nipple (brass) and the appropriate fitting assembly to connect 5/16", 3/8", 1/2", 5/8" or 3/4" tubing together



Part #	Mfg #	Description	Price
022651	A4322020	R20 x R20 Thread	
022655	A4322525	R25 x R25 Thread	

QS-Style Conversion Nipple (Thread x NPT)

- The QS-style Conversion Nipple (brass) and the appropriate fitting connect 5/16", 3/8", 1/2", 5/8" or 3/4" Uponor tubing to 1/2", 3/4" and 1" NPT



Part #	Mfg #	Description	Price
022653	A4322075	R25 x 3/4" NPT	

QS-Style Copper Adapter (Thread x CU)

- Use R20 or R25 adapter and appropriate QS-style fitting assembly to transition PEX tubing to 1/2" and 3/4" copper pipe



Part #	Mfg #	Description	Price
022657	A4332050	R20 x 1/2"	
022658	A4332075	R20 x 3/4"	

QS-Style Copper Fitting Adapter (Thread x Copper)

- Transition Uponor PEX tubing to 1/2" and 3/4" copper fittings



Part #	Mfg #	Description	Price
022660	A4342050	R20 x 1/2"	
022661	A4342075	R20 x 3/4"	

QS-Style Compression Manifold Fitting Assembly

- Sold as 3-Piece assembly



Part #	Mfg #	Description	Price
033672	A4020375	3/8" R20 Thread	
169119	A4030625	5/8" R25 Thread	
022646	A4020750	3/4" R25 Thread	

Panels and Plates

Quik Trak™ Panel

- The 1/2" plywood panels are attached to an aluminum heat transfer sheet



Use with Uponor 5/16" hePEX plus only

Part #	Mfg #	Description	Price
040685	A5060701	7" x 48"	

Quik Trak™ Return Panel

- Designed with a "U" groove to complete tubing turns
- The half-moon grooves are attached to the panels
- Each return panel is shipped with a separate aluminum sheet for installation beneath the panel



Use with Uponor 5/16" hePEX plus only

Part #	Mfg #	Size	Price
040686	A5060702	7" x 48"	

Quik Trak™ Joist Trak

- Extruded aluminum heat transfer panels
- Each panel is 4' long x 4" wide
- Comes packaged 20 per box



Part #	Mfg #	Size	Price
066612	A5080500	1/2"	

Uponor (Wirsbo) Heating

Heating - Hydronic

Fast Trak™ Edge Strip

- Ideal over pour installation method for remodel and retrofit applications
- Preformed knobbed mats
- 5/16" PEX tubing



Part #	Mfg #	Description	Price
145575	A5090313	Fast Trak 0.5. 8.3ft ² /panel	
145576	A5091000	Strip, 65-ft roll	

ProPEX® Escutcheon's

- Flared sleeve
- Attractive cover for 1/2" AQUAPEX® tubing and ProPEX connections as they exit the wall



Part #	Mfg #	Description	Price
118898	F5670500	White	
119669	F5650500	Chrome Plated	

Differential Pressure By-Pass Valves

- The self-acting, automatic maintains flow rates (e.g., through a low-water content gas boiler), or controls the differential pressure in a hydronic heating system
- Valves come with NPT unions

Part #	Mfg #	Size	Price
075522	A5411000	1"	

Installation Aids

PVC Plastic Bend Support

- Provides rigid 90° bend for 1/2", 5/8", 3/4" and 1" Uponor PEX exiting a concrete slab



Part #	Mfg #	Size	Price
023227	A5500500	1/2"	
023195	A5500625	5/8"	
023228	A5500750	3/4"	
040374	A5501000	1"	

Metal Bend Support

- Zinc-plated
- Provides rigid 90° bend for 1/2", 5/8" and 3/4" nominal PEX tubing products



Part #	Mfg #	Size	Price
027955	A5110500	1/2"	
011777	A5110625	5/8"	
022596	A5110750	3/4"	

PEX Clip - Plastic

- Enhanced Uponor PEX clips provide better holding power and can be attached together laterally for tight installations
- PEX Clips are attached under the wood subfloor for joist-heating applications
- Clips prevent tubing from coming in direct contact with subfloor
- Dry wall screws are commonly used to secure the clips to the wood subfloor



Part #	Mfg #	Size	Price
028881	F7051258	1/2" & 5/8"	
137214	F7057500	3/4"	
137215	F7051001	1"	

Fixing Wire

- 6" Galvanized steel tie used to secure PEX tubing products to wire mesh or rebar
- Use with fixing wire twister or auto fixing wire twister (ratchet style)



Part #	Mfg #	Description	Price
011770	A7031000	Fixing Wire, 1000 per Bundle	

Ratchet-Style Fixing Wire Twister

- For use with A7031000 fixing wire



Part #	Mfg #	Description	Price
019018	E6091700	Fixing Wire Twister	

Fixing Wire Twister

- For use with A7031000



Part #	Mfg #	Description	Price
011767	E6090005	Fixing Wire Twister	

Uponor (Wirsbo) Heating

Quik Trak™ Sealant

- 100% Silicone
- Used to adhere tubing in groove and provide good thermal transfer



Part #	Mfg #	Size	Price
040690	E6050010	10.3 fl oz	

PEX Foam Stapler

- Ideal solution for securing Uponor PEX and (MLC) tubing to foam board insulation in concrete slab radiant heating and cooling applications



Part #	Mfg #	Description	Price
171329	E6025000	PEX Foam Stapler	

Foam Staple

- For use with E6025075 manual stapler
- Plastic foam staple used to secure 1/2", and 5/8" PEX to rigid insulation
- Use part A7015050 for 1" foam and part A7015075 for 1-1/2" or thicker foam



Part #	Mfg #	Size	Price
040682	A7015050	1-1/2"	
033641	A7015075	2-1/2"	

PEX Foam Staple

- For use with Uponor PEX foam stapler (E6025000) to secure 3/8", 1/2", and 3/4" PEX or 1/2" and 5/8" MLC tubing



Part #	Mfg #	Description	Price
171328	A7012000	2"	

Metal Tubing Staple

- Use 5/8" staple to secure aluminum plates to furring strips or subfloors
- Use 1-1/4" staples in staple-down installations to secure 1/2" and 5/8" Uponor PEX to wood subfloors

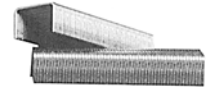

Part #	Mfg #	Size	Pkg Qty	Price
143722	A7011250	1-1/4"	10,000/Box	

PEX Tubing Cutter



Part #	Mfg #	Description	Price
011750	E6081125	Metal Tube Cutter Cuts to 1" PEX	
083129	E6081128	Plastic Tube Cutter Cuts to 1" PEX (3/4")	

TruFLOW Manifold Balancing Hex Key

- Use on the supply manifold to adjust the flow rate across the loop for balancing



Part #	Mfg #	Description	Price
081829	A2620002	Replacement Part, Hex Key	

Tube Uncoiler

- Facilitates uncoiling of up to 1" PEX tubing
- Simplifies installation and reduces labor
- Weighted arms hold tubing in place while uncoiling
- Eyelet keeps tubing from tangling
- Base is collapsible
- No additional hardware needed to attach arms
- Easy to assemble
- Upon assembly, guide pin must be moved on the swivel guide arm in order to keep it in place



Part #	Mfg #	Description	Price
035147	E6061000	Tube Uncoiler	

Uponor (Wirsbo) Heating

Heating - Hydronic

Zoning Controls - Radiant Heating

Zone Control Module

- 4-Zone control module for 2-wire operation



Part #	Mfg #	Description	Price
155032	A3031003	3-Zone 2-Wire Operation	
159894	A3031004	4-Zone, 2-Wire Operation	
074018	A3030009	Replacement Fuse (2 amps)	

Uponor Thermal Actuator

- Slow-opening Thermal Actuator (24VAC) mounts directly onto 1-1/4" brass and TruFLOW valved manifolds
- Provides individual loop flow control on a multi-zoned manifold (manifold serving more than one zone)
- The 4-wire Thermal Actuator includes end switch for activation of relay (pump), heat plant or other auxiliary devices
- Do not mount actuators upside down



Part #	Mfg #	Description	Price
171719	A3023522	4-Wire Thermal Actuator	

Motorized Valve Actuator (MVA)

- 24VAC Quick-opening motorized valve head mounts directly onto TruFLOW Valved Manifolds
- The open/close indicator allows for easy visual inspection
- Provides individual flow control on a multi-zoned manifold (manifold serving more than one zone)
- Includes end switch for activation of relay (pump), heat plant or other auxiliary devices
- Do not mount actuators upside down



Note: The MVA is not compatible with the Uponor Genius™ control system

Part #	Mfg #	Description	Price
026818	A3020522	4-Wire MVA	

Uponor Set Point Thermostat

- Comfort controllers
- Early start features for recovery from setback
- Override feature for periods of extended absence
- Attractive sleek design



Part #	Mfg #	Description	Price
067076	A3041501	501s, 1-Stg, Floor Sensor	

Pump Relay

- Single-zone relay includes secondary low-voltage terminals for boiler operation
- Three-zone relay includes secondary low-voltage terminals for boiler operation and DHW priority options

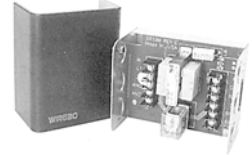

Part #	Mfg #	Description	Price
041378	A3080301	24V 3-Zone Multi Pump Relay	

Uponor (Wirsbo) Heating

Radiant Heat Tools

Foamboard Stapler

- Operate from standing position
- Ergonomic D-grip handle
- Solid 1-piece magazine
- Leaf spring controlled stop automatically adjusts to set up staple and guide it through the fastening mechanism



Part #	Mfg #	Description	Price
101994	FBSN	37" Height	

Foamboard Staple

- Extra sharp multi-barbed
- 1-1/2" Staples for 1" foamboard
- 2-1/2" Staples for 2" foamboard



Part #	Mfg #	Description	Price
114593	FBSN1	1-1/2" Staples, 200/Pk	
101995	FBSN2	2-1/2" Staples, 200/Pk	

Uponor (Wirsbo) Heating

Heating - Hydronic

Thermostatic Mixing Valves

AM-1 Series 3-Way Thermostatic Mixing Valve (Union Sweat)

- Adjusts, maintains and limits the hot water temperature to a desired setting selected by user
- In domestic use, offers scalding protection and bacteria growth control
- Dual purpose mixing or diverting
- Proportional valve
- Nickel-plated brass construction, EPDM o-rings



Part #	Mfg #	Pipe Size	Operating Temperature	Price
099800	AM-101R-US-1	3/4"	80° - 180°F	
099799	AM-102R-US-1	1"	80° - 180°F	

Watts Heating

Stainless Steel Manifolds

- Sold in pairs, mounted to metal bracket
- SS-T20 style fittings are compatible with Stainless Steel manifolds

1" Stainless Steel Flow meter Manifold



D380300SS

Part #	Mfg #	Order #	Size	Price
114949	D3803008SS	81001985	M-8	
139848	D3803009SS	81003687	M-9	
139847	D3803012SS	81001987	M-12	

Manifold Accessories

Stainless Steel Manifold ISO BV Accessory Kit

- Includes:
 - (1) Vent and purge assembly
 - (1) Manifold end cap
 - (2) FNPT Trunk isolation ball valves
 - Manifold adapters
 - Neoprene and fiber gaskets
- Order Onix, Crimp or compression fittings separately



Part #	Mfg #	Order #	Size	Price
114165	DK1000	81003736	1"	

Valve Actuator

- For automatic circuit control
- Optional feature for mounting directly to the balancing manifold
- Incorporates an indicator window that allows you to visually determine whether the valve is fully open or closed
- Provides on/off flow control to individual radiant circuits
- Flow can be balanced prior to installing by turning the adjustment valve under the blue cap
- Actuator is 24VAC with four wires to connect to the thermostat and circulating pump



Part #	Mfg #	Order #	Voltage	Price
127878	PZ656104	81001541	24V	

PEX Compression Fittings

SST20 PEX Compression Fitting

- PEX Compression x SST20 Swivel BSP
- For connecting:
 - PEX to stainless steel manifolds
 - Custom tubular T20 compression manifolds
 - 3/4" Male BSP x male sweat fittings
- Includes:
 - Insert fitting
 - Compression sleeve
 - BSP threaded nut



Part #	Mfg #	Order #	Size	Price
114166	PX690002-10	81005168	1/2" x 3/4"	
117479	PX690003-10	81005170	5/8" x 3/4"	

Misc. Accessories

Foam Staple Box

Part #	Mfg #	Order #	Size	Price
159249	81000825	Foam 2.25 Staple Box		

Heating - Hydronic

Air Purgers

Air Elimination

Air Purger

- Cast iron



Part #	Mfg #	Size	Dimensions H x W x L	Price
002010	443-1	1"	4" x 3" x 6"	
002011	444-1	1-1/4"	4" x 3" x 6"	
002012	445-1	1-1/2"	5" x 4" x 8"	
002013	446-1	2"	5" x 4" x 8"	



Air Vents

Air Eliminators Automatic Air Vent

- Brass body with non-ferrous internals
- Maximum operating temperature: 240°F



Part #	Mfg #	Model	Connection	Max Pressure	Price
002435	113001	7	1/8" FNPT	75 psig	
002468	113020	67	1/8" MNPT	35 psig	

Air Vents

(Air Eliminators)

SuperVent™ Air Eliminator

- Eliminates air from hydronic heating systems without bleeding
- No clog vent, dirt and debris resistant
- 360° Adjustable collar ring
- Bronze body
- Maximum temperature rating: 240°F
- Maximum operating pressure: 125 psi



NPT

Sweat

Part #	Mfg #	Size	Connection	Price
094289	PV075	3/4"	NPT	
094290	PV075S	3/4"	Sweat	
094291	PV100	1"	NPT	
094292	PV100S	1"	Sweat	
094293	PV125	1-1/4"	NPT	
094294	PV125S	1-1/4"	Sweat	
094295	PV150	1-1/2"	NPT	

Heating - Hydronic Accessories

Air Vents

Main Steam Vents

Model 75/75H Air Valve (Non-Vacuum)

- For medium and large systems
- Float-type thermostatic vent
- Single non-adjustable port
- 1/2" NPT Female and 3/4" NPT male straight shank
- Maximum pressure: 15 psig



Part #	Mfg #	Model	Max Operating Pressure	Price
005417	401434	75	3 psig	

Radiator Steam Vents

Model 1A Air Valve (Non-Vacuum)

- Float-type vent
- Adjustable port for true proportional venting - 6 port settings from slow (1) to fast (6)
- 1/8" NPT Angle connection
- Maximum operating pressure: 1-1/2 psig
- Maximum pressure: 10 psig



Part #	Mfg #	Model	Straight Shank	Price
005398	401422	1A	1/8" NPT Angle	

Water Vents

Model 79 Water Main Vent Valve

- For use on hot or cold or glycol water mains and process applications with specific gravity > 0.7
- Tapped at top for 1/8" NPT safety drain connection
- Removable top
- Built-in check valve
- Maximum operating pressure: 75 psig
- Maximum hydrostatic pressure: 200 psig
- Maximum temperature: 250°F



Part #	Mfg #	Model	Straight Shank	Price
005418	401488	79	1/2" FPT, 3/4" MPT	

Model 790 Water Vent Valve

- For removing air from convectors, baseboard and wall radiation
- Safety drain connection for discharging moisture
- Fitting and ferrule for 3/16" OD tubing
- Telescopic siphon tube
- Maximum operating pressure: 30 psig
- Maximum pressure: 30 psig



Part #	Mfg #	Model	Straight Shank	Price
005419	401479	790	1/8" NPT	

Model 791 Water Vent Valve

- For convectors and small frame
- Safety drain connection for discharging moisture
- Fitting and ferrule for 3/16" OD tubing
- Telescopic siphon tube
- Maximum operating pressure: 50 psig
- Maximum pressure: 50 psig



Part #	Mfg #	Model	Straight Shank	Price
005420	401482	791	1/4" NPT	

Heating - Hydronic Accessories

Air Vents & Gauges

Radiator Coin Key Air Valve & Key

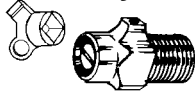

Part #	Mfg #	Description	Price
082258	R20-002	Key Only	
082257	R20-003	Valve Only	

Air Vents

SPIROTOP®

Brass Quick Air Releaser

- 20-Year limited warranty



Part #	Mfg #	Size	Price
017852	VTP 050 FT	1/2" FNPT	

SPIROVENT® JUNIOR

Brass Air Eliminators

- 20-Year limited warranty

Threaded Design



Part #	Mfg #	Size	Price
017848	VJR 075-TM	3/4" FNPT with 1/2" Tank	
017849	VJR 100-TM	1" FNPT with 1/2" Tank	
017850	VJR 125-TM	1-1/4" FNPT with 1/2" Tank	
017851	VJR 150-TM	1-1/2" FNPT with 1/2" Tank	
087403	VJR200-TM	2" FNPT with 1/2" Tank	

Sweat Design

Part #	Mfg #	Size	Price
089288	VJS 075-TM	3/4" Sweat with 1/2" Tank	
089289	VJS 100-TM	1" Sweat with 1/2" Tank	
089290	VJS 125-TM	1-1/4" Sweat with 1/2" Tank	

SPIROVENT® SENIOR

Steel Air Eliminator

- MT - Male threads



Part #	Mfg #	Size	Price
020540	VSR-200-MT	2" MNPT	
024735	VSR-250-MT	2-1/2" MNPT	
030532	VSR-300-MT	3" MNPT	

SPIROVENT® Quad

Steel Hydraulic Separator

- MT - Male threads
- FA - Flanged ASME

Part #	Mfg #	Size	Price
138420	VDX-200-MT	2" MNPT	

SPIROTRAP® Dirt Separators

Brass Dirt Separator

- Ball valve included
- Patented Spirotube® element



Part #	Mfg #	Pipe Size	Price
082005	TDN-125-FT	1-1/4" IPS	
082006	TDN-150-FT	1-1/2" IPS	

Heating - Hydronic Accessories

Air Vents

Boiler Feed Air Vents

DuoVent Automatic Air Vent with In-Line Testing Feature

- Maximum temperature: 240°F
- Maximum pressure: 150 psi



Part #	Mfg #	Model	Size	Price
062989	0590719	WADV18	1/8"	



Antifreeze & Other Chemicals

Harvey Heat Antifreeze



016850



016880



016905

Part #	Mfg #	Description	Price
072358	16750	Harvey Heat -100A, 1 gal	
072361	16760	Harvey Heat -100A, 5 gal	
007733	16850	Harvey Heat -100, 1 gal	
019596	16860	Harvey Heat -100, 5 gal	
021756	16870	Harvey Heat -100, 55 gal	
136190	016880	Harvey Heat RV, 1 gal	
108988	16900	Harvey Heat, Arctic Grade, 55 gal	
069501	016905	Harvey Heat, Arctic Grade, 5 gal	
069500	016910	Harvey Heat, Arctic Grade, 1 gal	

Antifreeze & Other Chemicals

Boiler Additives

Pro-Tek™ 922 - Hydronic Hot Water Closed-Loop Treatment

- Concentrated corrosion and scale inhibitor treatment specially formulated for hot water, closed-loop heating systems
- Prevents scale and corrosion on aluminum, copper, iron, brass and stainless steel
- Compatible with standard flexible tubing such as PEX and ONIX used in hydronic installations
- Helps control pH & removes oxygen
- Does not contain nitrite
- Non-hazardous



Part #	Mfg #	Size	Price
137022	922-1	1 gal	

RhoGard™ Heat Transfer Fluid

- Aluminum/Stainless Steel safe and multi-metal heat transfer fluid
- Non-toxic, environmentally friendly
- Can be dilute on-site w/ distilled or D.I. water
- Provides freeze protection to < -60°F
Provides burst protection to -100°F
- Meets and exceeds the corrosion protection requirements of ASTM D1384
- Heating, cooling, and solar system fluid



Part #	Mfg #	Size	Price
181175	RG-05	5 gal	

RhoGard™ Ultra Concentrated Antifreeze

- Aluminum safe and multi-metal antifreeze
- Hydronic and solar system fluid
- Freeze and corrosion protection fluid
- Concentrated Propylene Glycol plus multi-metal corrosion inhibitors
- Protects aluminum, cast iron, copper and steel
- Helps keep heat-exchange surfaces clean
- Helps keep efficiency high
- Non-hazardous
- Burst protection to -100°F
- Environmentally friendly
- Prevents corrosion



Part #	Mfg #	Size	Price
137009	RHOGARDULT RA5	5 gal	

Hydro-Solv™ 9100 Hydronic System Cleaner

- Removes bacteria, scale and corrosion
- Cleans aluminum, brass, copper, iron and steel
- Non-hazardous



Part #	Mfg #	Size	Price
137020	HYDRO-SOLV 9100	1 gal	

EnviroGard™ Ultra Heat HD Transfer Fluid

- All ingredients are listed by the USDA and FDA as (GRAS) "Generally Recognized as Safe".
- Approved by Department of Natural Resources and Department of Health for use in Geothermal Systems
- Concentrated for maximum economy
- Protects cast iron, copper and steel
- Provides freeze, corrosion and scale protection
- Helps keep heat-exchange surfaces clean
- Helps keep efficiency high
- Non-hazardous and non-toxic
- Burst protection to -100°F
- Environmentally friendly

Part #	Mfg #	Size	Price
137478	ENVIROGARD ULTRAHD55	55 gal	

Antifreeze & Other Chemicals

Gunk® Boiler Products

Rust Raider®

- Protect entire system
- Turns boiler water blue indicating safe conditions
- Water changes color when additional chemical is need



Part #	Mfg #	Size	Price
008855	B5-34	1 gal	
008856	B5-40	5 gal	

Heating - Hydronic Accessories

Antifreeze & Other Chemicals

Boiler Additives

Safe Liquid Boiler Stop Leak

- Forms a water insoluble seal
- Safe to use in all boilers
- Contains no petroleum or hazardous components
- Will not sludge or clog
- Will not surge
- Compatible with propylene glycol and ethylene glycol anti-freeze



Part #	Mfg #	Description	Price
010085	STOPLEAK	1 qt Can	

Squick Boiler Cleaner/Inhibitor with Anti-Foam Silicone SK-24

- Cleans and protects steam boilers by a patented absorption/precipitation process
- Absorbs grease oil, rust, dissolved and suspended solids
- Prevents formation of insulating scale and crystallizing solids
- Prevents corrosion, protects metal surfaces
- Neutralizes free oxygen
- Prevents foaming, surging or priming
- Maximizes heat transfer
- Safe to use in all boilers - contains no petroleum or hazardous components
- No draining, no blow down required



Part #	Mfg #	Description	Price
010084	SKSQU	5 oz Squick Boiler Cleaner	

#5 Hydronic Formula Cleaner/Inhibitor with Silicon SK-24

- Cleans and protects boilers and hydronic systems
- Prevents formulation of insulating scale on heat transfer surfaces
- Keeps dissolved solids in solution
- Frees and lubricates stuck zone valves
- Dissolves insulating sludge on tankless coils
- Prevents corrosion
- Protects and lubricates pump seals and quiets noisy circulators
- Insures maximum heat transfer
- Safe for all boilers - contains no petroleum or hazardous components
- Compatible with both ethylene glycol and propylene glycol antifreeze



Part #	Mfg #	Description	Price
010087	HF-5	1 qt	

Heating - Hydronic Accessories



Antifreeze & Other Chemicals

Anti-Freeze

Cryo-Tek™ Original

- Blend of 45% virgin propylene glycol and the triple protection inhibitor package
- Use in systems fabricated with metal, plastics (except CPVC) and rubber pipping, fittings, seals, and other parts



Part #	Mfg #	Size	Price
161803	35260	5 gal	

Cryo-Tek™ 100 Antifreeze

- Contains virgin (not recycled) propylene glycol with triple protection corrosion inhibitor
- Pre-mixed, ready-to-use formulation
- Pink liquid



Part #	Mfg #	Size	Price
144415	35284	5 gal	

Cryo-Tek™ AG

- Concentrated "Arctic Grade" anti-freeze solution
- Blue liquid.
- 100% pure virgin propylene glycol/triple protection inhibitor package
- Cryo-Tek can also be used in radiant tube heating systems, most solar heating systems and geothermal loops



Part #	Mfg #	Size	Price
176985	35285	5 gal	

Aquastats

Aquastats®

L4006A Immersion Type Aquastat Control

- Immersion type controllers for limiting or regulating temperatures of liquids in boilers or tanks
- SPST - Breaks circuit on temperature rise
- Visible control point scale and external adjustment screw permit easy setting
- Horizontal or vertical insertion of the sensing element
- Remote bulb model may be used to sense air temperature in ducts and in outside air sensing applications
- Includes: 3" insulation, Stop Factory-Set @240°F, Well Adapter & Heat-Conductive Compound



Part #	Mfg #	Temperature Operating Range	Temperature Differential, Mid scale	Price
006728	L4006A1678	100°-240°F	5°-30°F Adj	

L4006B Immersion Type Aquastat Control

- Immersion type controllers for limiting or regulating temperatures of liquids in boilers or tanks
- SPST Contacts make on temperature rise
- Includes: 3" Insulation, Stop Factory-Set @240°F, Well Adapter & Heat-Conductive Compound



Part #	Mfg #	Temperature Operating Range	Temperature Differential, Mid scale	Price
022280	L4006B1155	100° - 240°F	5° - 30°F Adj	

L4006E Immersion Type Aquastat Control

- High limit, manual reset
- Contacts break on temp rise
- Immersion type controllers for limiting or regulating temperatures of liquids in boilers or tanks
- Totally enclosed MicroSwitch™ snap-acting switches operate on temperature rise to set point
- Visible control point scale and external adjustment screw permit easy setting
- Horizontal or vertical insertion of the sensing element
- Includes: 3" Insulation, Well Adapter & Heat-Conductive Compound



Part #	Mfg #	Temperature Operating Range	Temperature Differential, Mid scale	Price
006729	L4006E1067	130° - 270°F	250°F	

Heating - Hydronic Accessories

Aquastats

L6006A Immersion High or Low Limit Aquastat Control, SPDT

- Remote bulb model may be used to sense air temperature in ducts and outside air sensing applications
- Totally enclosed MicroSwitch[®] snap-acting switch
- Visible control point scale and external adjustment screw permit easy setting
- Horizontal or vertical insertion of the sensing element
- Direct or well immersion of the sensing element
- Select models have wells
- Stop Factory-Set @ 240°F, Heat-Conductive Compound



Part #	Mfg #	Temperature Operating Range	Temperature Differential, Mid scale	Price
006740	L6006A1145	100° - 240°F	Stop Factory-Set @ 240°F, Heat-Conductive Compound	

L6006C Strap-On Mount High or Low Circulator Control, SPDT

- Remote bulb model may be used to sense air temperature in ducts and outside air sensing applications
- Totally enclosed MicroSwitch[™] snap-acting switch operates on temperature rise
- Visible control point scale and external adjustment screw permit easy setting
- Horizontal or vertical insertion of the sensing element
- Select models have wells



Part #	Mfg #	Temperature Operating Range	Includes:	Price
006741	L6006C1018	65° - 200°F	Stop Factory-Set @ 200°F	

Aquastat[®] Relays

L8148 Aquastat[®] Relay

- Immersion-type controllers that combine high limit protection with switching relay control of burner and circulator motors
- High limit opens burner circuit only
- Includes transformer and accessory terminals for adding a remote low limit controller
- Requires 24VAC thermostat with heat anticipator set at 0.2 amps
- Includes well adapter and heat-conductive compound
- Mounts horizontally or vertically
- Maximum Bulb: 40° over selected set point up to 265°F
- Maximum Ambient: 150° including zone valves with low voltage loads up to 1.2 amps



Part #	Mfg #	Description	Price
093128	L8148E1265	Line Voltage, 180° - 240°F High Limit, 4-1/2" Capillary, Vertical Mount	
006743	L8148J1009	Millivolt or Low Voltage, 120° - 240°F High Limit, 4-1/2" Capillary, Vertical/Horizontal Mount	

Heating - Hydronic Accessories

Aquastats

Aquastat® Controllers
L8100 Aquastat® Controller

- Immersion type controller for regulating and limiting tank temperature in water heaters
- Provides energy cutoff (ECO) action on temperature rise past set point
- Includes second sensing element to sense average water temperature to minimize stacking
- Internal adjustment screw
- Operating temperature range: 100° to 180°F



Part #	Mfg #	Description	Price
150551	L8100B1037	SPST, Contacts Break on Temperature Rise, 42" Capillary	

Accessories

Heat Conductive Compound

Part #	Mfg #	Description	Price
076507	107408	4 oz Heat Conductive Compound	

Well Assemblies



Part #	Mfg #	Description	Price
006831	121371A	3/8" x 3" Bulb Size, Copper 1/2" NPT, 1-1/2" Insulation, 3" Insertion Well with Mounting Clamp	
006832	121371B	3/8" x 3" Bulb Size, Copper 3/4" NPT, 1-1/2" Insulation, 3" Insertion Well with Mounting Clamp	

Thermometers

Thermometer with Thermowell

- Thermowell included to allow thermometer to be removed without draining the system
- Steel case, brass well



Part #	Mfg #	Connection	Dial	Temperature Range	Price
095933	GT162	1/2" NPT	2-1/2" Diameter	32° - 250°F	

Heating - Hydronic Accessories

Baseboard Radiation

Therma Trim Hydronic Baseboards Therma Trim Baseboard Enclosure



Part #	Mfg #	Description	Price
135109	611-111-005	2' Baseboard Enclosure with 3/4" Element	
135112	611-111-010	3' Baseboard Enclosure with 3/4" Element	
135113	611-111-015	4' Baseboard Enclosure with 3/4" Element	
135114	611-111-020	5' Baseboard Enclosure with 3/4" Element	
135115	611-111-025	6' Baseboard Enclosure with 3/4" Element	
135116	611-111-030	7' Baseboard Enclosure with 3/4" Element	
135117	611-111-035	8' Baseboard Enclosure with 3/4" Element	
135126	611-311-075	2' Baseboard Enclosure	
135127	611-311-080	3' Baseboard Enclosure	
135128	611-311-085	4' Baseboard Enclosure	
135129	611-311-090	5' Baseboard Enclosure	
135130	611-311-095	6' Baseboard Enclosure	
135131	611-311-100	7' Baseboard Enclosure	
135132	611-311-105	8' Baseboard Enclosure	

Therma Trim Baseboard Heating Element

Part #	Mfg #	Description	Price
135118	611-211-040	2' Baseboard 3/4" Heating Element	
135120	611-211-050	4' Baseboard 3/4" Heating Element	
135122	611-211-055	5' Baseboard 3/4" Heating Element	
135123	611-211-060	6' Baseboard 3/4" Heating Element	
135124	611-211-065	7' Baseboard 3/4" Heating Element	
135125	611-211-070	8' Baseboard 3/4" Heating Element	

Therma Trim Baseboard Accessories

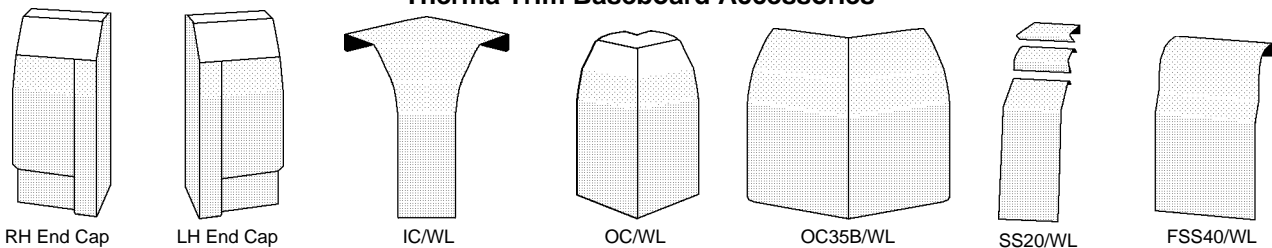

Part #	Mfg #	Description	Price
135135	611-411-145	4" Baseboard LH End Cap w/Hinge	
135136	611-411-150	4" Baseboard RH End Cap w/Hinge	
135137	611-411-155	2" Baseboard LH End Cap	
135138	611-411-160	2" Baseboard RH End Cap	
135139	611-411-185	2" Baseboard Full Front Splice	
135140	611-411-190	90° Inside Corner	
135141	611-411-195	90° Outside Corner	
135142	611-411-205	135° Outside Bay Corner	
135143	611-411-210	135° Inside Bay Corner	
135144	611-411-225	Support Bracket with Pivot	
047845	611-490-226	Baseboard Supply Tube Hanger	

Boiler & Zone Controls

Commercial Remote Temperature Controls

T775 Electronic Remote Temperature Controller

- Includes platinum sensor
- Set point range: -40° to 248°F
- Differential temperature: 1° to 150°F
- Heat or cool
- 24/120/240VAC, 50/60Hz



Part #	Mfg #	Control Mode	Temp Inputs	Relay Outputs	Notes	Price
141882	T775P2003	SPDT	3	4	50021579-001 (Three)	
190396	T775L2007/U	SPDT	2	4	Stage Sequencer w/ Reset	

Pressuretrol® Pressure Controllers

PA404A Pressuretrol® Controller

- Provides control for steam pressure
- Sensitive pressure-actuated diaphragm expands or contracts with pressure variations moving lever mechanism operating snap-switch
- SPST Snap-acting switch
- Differential: 1 to 5 psi
- Safety control for steam heating boilers, breaks an electrical circuit to shut down burner if steam pressure rises above safe level
- Makes at set point on pressure fall, breaks at set point plus differential on pressure rise



Part #	Mfg #	Description	Price
006744	PA404A1033	SPST, 0.5 to 9.0 psi	

PA404B Pressuretrol® Controller

- Provides control for steam pressure
- Sensitive pressure-actuated diaphragm expands or contracts with pressure variations moving lever mechanism operating snap-switch
- SPST Snap-acting switch
- Used with suspension-type unit heaters to make the fan circuit when a pressure rise indicates the presence of steam
- Breaks at setpoint on pressure fall, makes at setpoint plus differential on pressure rise



Part #	Mfg #	Description	Price
042522	PA404B1023	Pressuretrol Controller, SPST, 0.5 to 9.0 psi, 1 to 5 psi Differential	

Heating - Hydronic Accessories

Boiler & Zone Controls

Aquatrol® Boiler Controls

AQ254 Aquatrol® Add-A-Temperature Expansion Control Panel

- Used in conjunction with an AQ250, AQ25A, AQ251 or AQ252 control panels
- Provides one additional loop temperature control capability for the AQ2000 control panel it is connected to and expands the total network capacity by up to (16) zones when used with AQ255 and/or AQ257 zoning panels



Part #	Mfg #	Description	Price
134582	AQ25400B	Add-a-Temperature Expansion Control Panel	

AQ255/AQ257 Aquatrol® Expansion Zoning Panel

- For zoning with pumps or zone valves
- Easily switch from zone valves to pumps with same zoning module - just flip one DIP switch
- Ensures correct voltage is applied to all zone equipment on a panel (120VAC for pumps, 24VAC for valves)
- Works with AQ1000 2-wire communicating thermostats and most digital thermostats and AQ2000 boiler control panels
- Can be combined with additional expansion zoning panels and an AQ2000 control panel for a total of (16) space heating zones



Part #	Mfg #	Description	Price
134583	AQ25542B	Aquatrol Zoning Panel for (4) Zones of Pumps less End Switches	

Heating - Hydronic Accessories

Boiler & Zone Controls

Zone Controls

Zone Circulator Switching Relay

- Universal replaceability and thermostat compatibility
- Indicator lights
- Snap-in PC board to existing enclosure
- Fully enclosed snap-out relay
- UL Approved

1-Zone



Part #	Mfg #	Number of Zones	Maximum Voltage (Input)	Maximum Combined Load	Enclosure Dimensions H x W x D	Price
088487	SR501-2	1	120VAC	5A	5-1/4" x 4-1/4" x 2-3/4"	
095583	SR502	2 with Priority	120VAC	15A	6-3/4" x 10-1/4" x 2-3/4"	
068767	SR503	3 with Priority	120VAC	15A	6-3/4" x 10-1/4" x 2-3/4"	
068768	SR504	4 with Priority	120VAC	20A	6-3/4" x 10-1/4" x 2-3/4"	
095584	SR506	6 with Priority	120VAC	20A	7-1/2" x 11-3/4" x 3"	

Zone Valve Control

- All zone valve controls are relay type DPDT and have single phase motor rating per zone of 1/7 hp (SA) @ 120VAC



ZVC404

ZVC406

Part #	Mfg #	Number of Zones	Transformer Voltage (Input)	Max Output At 24 VAC	Enclosure Dimensions H x W x D	Price
095585	ZVC403-2	3 with Priority	120VAC	40 VA	6-3/4" x 10-1/4" x 2-3/4"	
095587	ZVC404-2	4 with Priority	120VAC	40 VA	6-3/4" x 10-1/4" x 2-3/4"	
095588	ZVC405-3	5 with Priority	120VAC	80 VA	7-1/2" x 11-3/4" x 3"	
095590	ZVC406-3	6 with Priority	120VAC	80 VA	7-1/2" x 11-3/4" x 3"	

Boiler & Zone Controls

Single-Stage Low Voltage Thermostats

Universal Single-Stage Mechanical Replacement Thermostat

- Mercury free
- 24V Replacement for hundreds of White-Rodgers and competitive models installed during the past 50-years
- Same footprint as older models with updated styling
- Enclosed contacts for increased reliability and accuracy
- Heat/cool with heating or cooling 3-wire zone mounting plate included
- Packaging is bilingual (English/Spanish)
- 5-Year warranty



Part #	Mfg #	System	Applications	Style	Color	Terminals	Price
145434	1F56N-444	1 Heat/1 Cool RC,RH,W,Y,G,O,B,A	24V, mV, 3wZn	Horizontal	White		

Boiler & Zone Controls

Heating Controls

356 Mixing Control

- Microprocessor-based (PID) outdoor reset control
- Designed to operate a permanent capacitor, impedance protected or equivalent pump at varying speeds
- Provides for boiler minimum protection and operation
- 120VAC Rated relay outputs

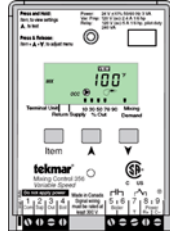

Part #	Mfg #	Description	Price
047999	356	Variable Speed Reset Controller w/Sensors	

274 Boiler Control

- Microprocessor PID control
- One tN4, four stage boiler & DHW/setpoint control
- Can provide outdoor reset, domestic hot water and setpoint operation with priority
- Not a safety (limit) control
- Indoor use only
- Operates up to four on/off boilers

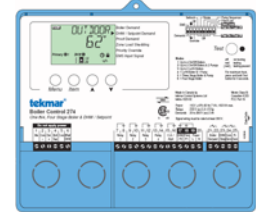

Part #	Mfg #	Description	Price
127773	274	Boiler Control (1) tN4, 4-Stage Boiler & DHW/Setpoint	

Thermostats

Setpoint Controls

- Microprocessor based control
- Extremely accurate +/- 0.5°F
- Wide temperature ranges
- Remote sensing up to 500 feet
- Large load relay capacity
- Low power consumption

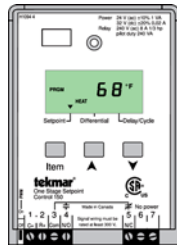

Part #	Mfg #	Description	Price
030576	150	1-Stage Setpoint Control	

Snow Melting Controls

Automatic Snow Melting Control

- Automatic snow/ice detection
- Warm weather cut-off
- Cold weather cut-off
- Accurate slab temperature control
- Slab outdoor reset



090/091

Part #	Mfg #	Description	Price
020296	090	Snow/Ice Sensor	
020298	091	Snow/Ice Sensor Socket	

Boiler/DHW Controls

256 Boiler Control

- Microprocessor-based (PID) control
- Regulates supply water temperature from a single boiler based on outdoor temperature
- Includes:
 - Warm weather shut down (WWSD)
 - Minimum boiler setting
 - Liquid crystal display (LCD)

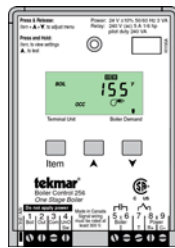

Part #	Mfg #	Description	Price
047998	256	1-Stage Boiler Control	

667 Snow Detector & Melting Control

- Variable speed injection
- When combined with 090 snow/ice sensor provides automatic snow/ice detection
- Operates a variable speed injection pump to provide several protection and control features
- Microprocess PID control
- Not a safety (limit) control

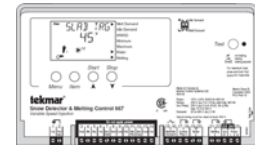

Part #	Mfg #	Description	Price
065840	667	Snow Detector & Melting Control	

Heating - Hydronic Accessories

Boiler & Zone Controls

Sensors

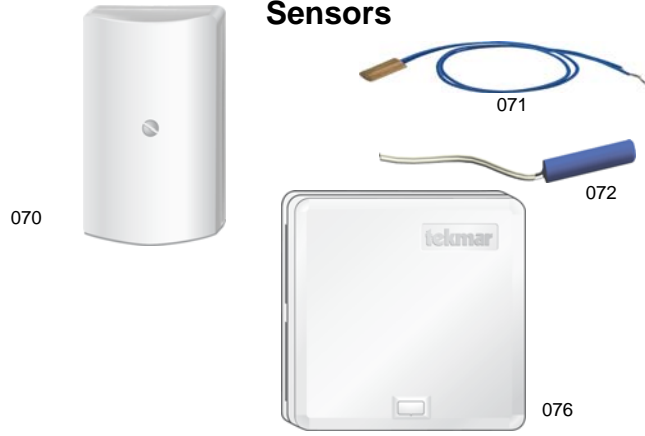

Part #	Mfg #	Description	Price
065350	070	Outdoor Sensor	
037312	071	Universal Sensor w/12" 2-Cond Wire	
044387	072	Slab Sensor w/PVC Sleeve & 20' 2-Cond Wire	
044864	076	Indoor Sensor, Surface Mount	

Heating - Hydronic Accessories

Boiler Accessories

Hose End Valves

74-CL Multi-Turn Boiler Drain

- Buna-N seat
- 125 psi to 100°F
- Max temp: 180°F
- Screw-in bonnet



Part #	Mfg #	Size	Price
168326	N64N008	1/2"	
168327	N64N006	3/4"	

Boiler Drains

Boiler Drains

BD Series Brass Boiler Drain Shut-Off

- 3/4" Hose thread connection on outlet
- Brass body construction
- Cast iron hand wheel
- Maximum pressure: 200 psi
- Maximum temperature: 180°F



Part #	Mfg #	Model	Size	Pattern	Price
013030	0820901	BD1C	1/2" Dual Conn	Angle	
014608	0820902	BD2C	3/4" MNPT	Angle	

BT Series 1/4-Turn Boiler Drain Shut-Off

- 3/4" Hose thread connection on outlet
- Brass body construction
- Tee handle with positive shutoff
- Adjustable Teflon® stem packing
- Maximum pressure: 200 psi



Part #	Mfg #	Model	Size	Price
053099	0820955	BD-QT	1/2" Dual Pattern, MIP or Solder	
053100	0820956	BD-QT	3/4" MNPT	

Circulator Pumps

UP Circulator Pumps - Closed Systems

- Wet rotor, single-stage, direct drive centrifugal pumps designed for domestic and light commercial applications
- Built-in motor protection
- Quiet, maintenance-free performance
- Flushed bearing design
- 60Hz
- Maximum working pressure: 145 psi
- Minimum fluid temperature: 36°F (unless noted)
- 2-Pole motor, single-phase
- 3-Year warranty

UP 15-42F Brute II® Cast Iron Circulator Pump

- Cast iron construction
- For residential and light commercial applications
- Flange: (2) 1/2" diameter bolt holes
- Flow range: 0 to 17 gpm
- Head range: 0 to 15'
- 1/2 hp



Part #	Mfg #	Amps	Volts	Capacitor	Price
004957	UP 15-42 F	0.74A	115V	10µF/180V	

UPS 15-58FC/FRC (3-Speed Motor) SuperBrute Cast Iron Circulator Pump

- Fits most standard hydronic applications
- Cast iron construction
- Includes removable check valve
- Flange - (2) 1/2" diameter bolt holes
- Flow range: 0 to 17 gpm
- Head range: 0 to 19.5'
- Minimum liquid temperature: 36°F
- Maximum liquid temperature: 230°F
- 1/25 hp



Part #	Mfg #	Amps	Volts	Capacitor	Price
076106	UPS 15-58 FC	0.55-0.75A	115V	10µF/180V	
118361	UPS 15-58 FRC	*0.55-.075A	115V	10µF/180V	

* Reversing

UP 26-64F Cast Iron Circulator Pump

- Cast iron construction
- Flange: (2) 1/2" diameter bolt holes
- Flow range: 0 to 32 gpm
- Head range: 0 to 24.5'
- 1/12 hp



Part #	Mfg #	Amps	Volts	Capacitor	Price
004960	UP 26-64 F	1.7A	115V	8µF/180V	
Less Flanges					

UPS 26-99FC (3-Speed Motor) SuperBrute Cast Iron Circulator Pump

- Cast iron construction
- Includes removable check valve
- Flange: (2) 1/2" diameter bolt holes
- Flow range: 0 to 33 gpm
- Head range: 0 to 29'
- Minimum liquid temperature: 36°F
- Maximum liquid temperature: 230°F
- 1/6 hp



Part #	Mfg #	Amps	Volts	Capacitor	Price
098645	UPS 26-99 FC	1.3-1.8A	115V	20µF/180V	
106130	UPS 26-99 FC	1.3-1.8A	230V	20µF/180V	

UP 26-99F Cast Iron Circulator Pump

- Cast iron construction
- Flange: (2) 1/2" diameter bolt holes
- Flow range: 0 to 34 gpm
- Head range: 0 to 32'
- Minimum liquid temperature: 32°F
- Maximum liquid temperature: 230°F
- 1/6 hp



Part #	Mfg #	Amps	Volts	Capacitor	Price
004963	UP 26-99 F	2.15A	115V	10µF/380V	
004962	UP 26-99 F	2.15A	115V	10µF/380V	
Less Flanges					
059847	UP 26-99 F	1.07A	230V	2.5µF/180V	

Heating - Hydronic Accessories

Circulator Pumps

UP 26-116F Cast Iron Circulator Pump

- Cast iron construction
- Flange: (2) 1/2" diameter bolt holes
- Flow range: 0 to 37 gpm
- Head range: 0 to 37'
- Minimum liquid temperature: 32°F
- Maximum liquid temperature: 150°F
- 1/6 hp



Part #	Mfg #	Amps	Volts	Capacitor	Price
079629	UP 26-116 F	1.75A	230V	2.5µF/380V	

UPS 43-44FC (3-Speed Motor) SuperBrute Cast Iron Circulator Pump

- Cast iron construction
- For applications requiring higher head
- Includes removable check valve
- 2-Pole, single-phase
- Flange: (2) 1/2" diameter bolt holes
- Flow range: 0 to 63 gpm
- Head range: 0 to 14'
- Minimum liquid temperature: 32°F
- Maximum liquid temperature: 230°F
- Maximum system pressure: 145 psi
- 1/6 hp



Part #	Mfg #	Amps	Volts	Capacitor	Price
098646	UPS 43-44 FC	1.4-1.8A	115V	20µF/180V	

UP 43-75F Cast Iron Circulator Pump

- Cast iron construction
- Flange: (2) 1/2" diameter bolt holes
- Flow range: 0 to 41 gpm
- Head range: 0 to 25'
- 1/6 hp



Part #	Mfg #	Amps	Volts	Capacitor	Price
004964	UP 43-75 F	2.15A	115V	10µF/180V	

UPS 26-150F (3-Speed Motor) SuperBrute Cast Iron Circulator Pump

- Cast iron construction
- Flow range: 0 to 53 gpm
- Head range: 0 to 46'
- Flange: (2) 1/2" diameter bolt holes
- 2-Pole, single-phase
- Minimum liquid temperature: 36°F
- Maximum liquid temperature: 230°F
- Maximum system pressure: 145 psi
- 1/6 hp



Part #	Mfg #	Amps	Volts	Capacitor	Price
130966	UPS 26-150 F	2.5-3.5A	115V	40µF/180V	

UPS 43-100F (3-Speed Motor) SuperBrute Cast Iron Circulator Pump

- Flow range: 0 to 65 gpm
- Head range: 0 to 31'
- Flange: (2) 1/2" diameter bolt holes
- 2-Pole, single-phase
- Minimum liquid temperature: 36°F
- Maximum liquid temperature: 230°F
- Maximum system pressure: 145 psi
- 1/6 hp



Part #	Mfg #	Amps	Volts	Capacitor	Price
130968	UPS 43-100 F	3.5A	115V	40µF/180V	

Series UP Comfort Recirculation Pump UP 10-16B5 Hot Water Recirculation Pump

- Specifically designed for heating systems
- Flow range: 0 to 3.5 gpm
- Head range: 1 to 5.4'
- Minimum fluid temperature: 36°F
- Maximum fluid temperature: 203°F
- Maximum working pressure: 145 psi
- Features:
 - LC = Line cord
 - TLC = Timer and line cord
 - ATLC = Aquastat, timer, line cord
 - BU ATLC = Aquastat, timer, line cord, check valve and isolation valve



Part #	Mfg #	Connection	Price
057808	UP 10-16 BU/ATLC	1-1/4" Union	

Heating - Hydronic Accessories

Circulator Pumps

UP Comfort Series Recirculation Kit

- Includes:
 - (1) Pump
 - (1) Valve
 - (2) 1/2" FNPS x 1/2" FNPS x 12" Stainless steel flex hoses



Part #	Mfg #	Description	Price
061116	595916	Recirculation Kit	

UP Circulator Pumps - Open Systems

- Wet rotor, single-stage, direct drive centrifugal pumps designed for domestic & light commercial applications
- For open systems 140°F is maximum recommended fluid temp to avoid precipitation of calcium in water
- Built-in motor protection
- Quiet, maintenance-free performance
- Flushed bearing design
- 60Hz
- 2-Pole, single-phase

UP 15-10B5 Circulator Pump

- Brass, lead-free housing
- 115V, 0.22A, 25W, 1/25 hp
- Capacitor: 2µF/400V



Part #	Mfg #	Connection	Price
039691	UP 15-10 B5	1/2" Sweat	
040255	UP 15-10 B7	3/4" Sweat	

UP 15-42B5 Bronze Circulator Pump

- Bronze construction
- 1/2" Sweat connection
- UP15-42B5 Includes line cord
- LC/TLC Models have 6'3" power cord
- 1/25 hp



Part #	Mfg #	Amps	Volts	Capacitor	Price
023051	UP 15-42 B5	0.74A	115V	10µF/180V	

UPS 15-55SFC (3-Speed Motor) SuperBrute Stainless Circulator Pump

- Stainless construction
- Flange: (2) 1/2" diameter bolt holes
- Includes removable check valve
- Flow rate: 0 to 25 gpm
- Head range: 0 to 18'
- 2-Pole, single-phase
- Minimum liquid temperature: 36°F
- Maximum liquid temperature: 230°F
- Maximum system pressure: 145 psi
- 0.12 hp



Part #	Mfg #	Amps	Volts	Capacitor	Price
110243	UPS 15-55 SFC	.53-.75A	115V	10µF/180V	

UP 26-96BF Bronze Circulator Pump

- Bronze construction
- Flange: (2) 1/2" diameter bolt holes
- Flow range: 0 to 28 gpm
- Head range: 0 to 30'
- 1/12 hp



Part #	Mfg #	Amps	Volts	Capacitor	Price
004961	UP 26-96 BF	1.7A	115V	110µF/180V	

UPS 26-99BFC (3-Speed Motor) SuperBrute Bronze Circulator Pump

- Bronze construction
- Flange: (2) 1/2" diameter bolt holes
- Includes removable check valve
- Flow range: 0 to 33 gpm
- Head range: 0 to 29'
- Minimum liquid temperature: 36°F
- Maximum liquid temperature: 230°F
- Maximum system temperature: 145 psi
- 1/6 hp



Part #	Mfg #	Amps	Volts	Capacitor	Price
109851	UPS 26-99 BFC	1.3-1.8A	115V	20µF/180V	

Heating - Hydronic Accessories

Circulator Pumps

UP 26-116BF Bronze Circulator Pump

- Cast iron construction
- Flange: (2) 1/2" diameter bolt holes
- Flow range: 0 to 37 gpm
- Head range: 0 to 37'
- Minimum liquid temperature: 32°F
- Maximum liquid temperature: 150°F
- 1/6 hp



Part #	Mfg #	Amps	Volts	Capacitor	Price
099263	UP 26-116 BF	1.75A	115V	2.5µF/380V	

UP 15-29SF Stainless Circulator Pump

- Stainless steel construction
- Flange pipe connection
- Flow range: 0 to 20.5 gpm
- Head range: 0 to 9.7'
- Maximum fluid temperature: 230°F
- 0.12 hp



Part #	Mfg #	Amps	Volts	Capacitor	Price
109850	UP 15-29 SF	0.75A	115V	10µF/180V	

UP 15-29SU Stainless Circulator Pump

- Stainless steel construction
- 1/4" Union pipe connection
- Flow range: 0 to 20.5 gpm
- Head range: 0 to 9.7'
- Maximum fluid temperature: 230°F
- T Suffix: timer
- LC Suffix: 6', 3-prong line cord
- 0.12 hp

Part #	Mfg #	Amps	Volts	Capacitor	Price
114552	UP 15-29 SUC/TLC	0.75A	115V	10µF/180V	

UPS 15-35SFC (3-Speed Motor) Super Brute Stainless Circulator Pump

- Stainless steel construction
- Flange pipe connection
- Capacitor: 10µF/180V
- Flow range: 0 to 21.5 gpm
- Head range: 0 to 12'
- 2-Pole, single-phase
- Minimum liquid temperature: 36°F
- Maximum liquid temperature: 165°F
- Maximum system pressure: 145 psi
- Removable check valve
- 1/3 hp



Part #	Mfg #	Amps	Volts	Price
110113	UPS 15-35 SFC	0.06-0.95A	115V	

UP 43-75BF Bronze Circulator Pump

- Bronze construction
- Flange: (2) 1/2" diameter bolt holes
- Flow range: 0 to 41 gpm
- Head range: 0 to 25'
- 1/6 hp



Part #	Mfg #	Amps	Volts	Capacitor	Price
026604	UP 43-75 BF	2.15A	115V	10µF/180V	

Comfort Hot Water Recirculation Solutions - Retrofit

- Stainless steel construction
- No return line required
- Installs in less than one hour
- No electricity needed under sink
- Uses less energy than 25-watt light bulb
- Can save up to 16,000 gallons of water per year
- Flow range: 0 to 6.3 gpm
- Head range: 0 to 5.1'
- Minimum liquid temperature: 36°F
- Maximum liquid temperature: 150°F
- Maximum system pressure: 145 psi



Part #	Mfg #	Description	Price
061115	595926	Comfort Valve	

Heating - Hydronic Accessories

Circulator Pumps

ALPHA™ Energy-Efficient Circulator Pumps

- AUTOAdapt™ measures system changes automatically and maximizes energy savings
- LED Display shows flow indication and power consumption
- Plugs connections; no wiring required
- Motor: 1X115V
- 115V, 0.65A, 5 to 45W, 1/16 hp
- Flow range: 0 to 21 gpm
- Head range: 0 to 19'
- Maximum working pressure: 150 psi
- Minimum fluid temperature: 36°F
- Maximum fluid temperature: 230°F



ALPHA 15-55F



ALPHA 15-55SF

Closed System

- Cast iron construction

Part #	Mfg #	Connection	Price
233306	15-55FC	GF 15/26 Flange & Line Cord, (2) 1/2" Diameter Bolt Holes	

VersaFlo® Circulator Pumps

VersaFlo® UPS32 - Cast Iron - 3-Speed

- Flanges: 2-Bolt with (2) 1/2" diameter hole
- Flow range: 9 to 78 gpm
- Head range: 1 to 46'
- Maximum working pressure: 145 psi
- Maximum fluid temperature: 140°F



Part #	Mfg #	Motor Poles	HP	Volts	Price
048821	UPS 32-80/2	2-Pole	1/2	115V	

VersaFlo® UPS50 - Cast Iron - 3-Speed

- Flanges: 2", 4-bolt with (4) 9/16" diameter holes (non-ANSI)
- Flow range: 20 to 180 gpm
- Head range: 1 to 62'
- Maximum working pressure: 145 psi
- Maximum fluid temperature: 140°F



Part #	Mfg #	Motor Poles	HP	Volts	Price
031312	UPS 50-80/4	2-Pole	3/4	115V	

Heating - Hydronic Accessories

Circulator Pumps

Flange Sets

Flange Set for Stainless Steel Body Union Mount Pumps

UP15-18SU - UP15-42SU - UP25-64SU

Bronze Half Union Set



Part #	Mfg #	Description	Price
058001	529913	1/2" Sweat Half Union	
058000	529911	3/4" Sweat Half Union	

Flanges for Stainless Steel or Bronze Body Flange Mount Pumps

- For use with UM15-18SF, UP15-42SF, UP25-64SF, UP26-96BF, UP26-99BF, & UP43-75BF pumps

Bronze Threaded Valve Set



Part #	Mfg #	Description	Price
004999	519651	3/4" Threaded	
005000	519652	1" Threaded	
034876	539615	1-1/2" Threaded for UP43-75BF	

Flange for Cast Iron Body Flange Mount Pumps

- Includes:
 - (2) Flanges
 - (2) Gaskets
 - (8) Nuts and bolts

Cast Iron Threaded Flange Set



Part #	Mfg #	Description	Price
004995	519601	3/4" Threaded	
004996	519602	1" Threaded	
004997	519603	1-1/4" Threaded	
004998	519604	1-1/2" Threaded	
005005	539605	1-1/2" Threaded for UP43-75F	
084839	96409354	2" Threaded	

Timer Control

- 24-Hour programmable clock/timer
- For use with single speed, series UP circulators



Part #	Mfg #	Description	Price
091576	59-9388	115V Timer Control	

Grundfos® Parts

Part #	Mfg #	Description	Price
051161	GR510231	Full Faced Bolt Hole Style Flange/Gasket	
084284	510179	Gasket F/ UP/UPS/TP Flange Donut	
090178	530244	Gasket for 1-1/2" Flange	
045258	595444	3/4" Clip-On Aquastat Control	
046089	595443	Thermostatic Control, 1/2" Clip-On Mount for 5/8" OD System Piping Size	

Heating - Hydronic Accessories

Flow Valves

Flo-Check Valves

- Used in forced hot water heating system to prevent gravity circulation during periods when boiler is hot but space heating zone not wanted
- Maximum operating pressure: 125 psi
- Maximum operating temperature: 277°F
- Media: water or water/glycol



Part #	Mfg #	Size	Body	Type	Conn Inlet	Conn Outlet	Resistance in Feet of Pipe Equivalent	Price
103903	220	1"	Cast Iron	Universal	NPT	NPT	83.7/6.7	
103904	221	1-1/4"	Cast Iron	Universal	NPT	NPT	47.8/17	
103905	222	1-1/2"	Cast Iron	Universal	NPT	NPT	57.9/23.5	

Heat Exchangers

Heat Exchangers

Brazen Plate Heat Exchanger

- *Made of high quality acid-resistant stainless steel with 99.9% pure copper brazing*
- *Compact, lightweight, and designed for a variety of applications including radiant heating, snow melt systems and domestic hot water*
- *Counter flow design resulting high turbulence and maximum heat transfer*

Part #	Mfg #	Input BTUH	Flow Rate	Boiler Pressure Drop PSI	Water @ 90 Temp Rise	Water Pressure Drop PSI	Rated 1st Hour	Price
041811	WMBP1-14E	40,000	1.7 gpm	0.2 psi	0.8 gpm	0.0 psi	86	

Heating - Hydronic Accessories

Heat Exchangers

Heat Exchangers (Brazed Plate Heat Exchanger)

- Single wall copper brazed
- High heat transfer coefficient
- Small size with high heat transfer capacity
- Cost efficient
- Stainless steel 1-1/8" solder
- Easily installed



Part #	Mfg #	Size	Connection	Price
122451	LA14-20	7.5" x 3" x 2.29"	3/4"	
122452	LB31-30X	12" x 5" x 3.19"	1"	

Isolation Flanges

The Isolator® Uni-Flange Ball Valves

The Isolator® Uni-Flange Ball Valve (IPS x Flange)

- Full port forged brass ball valve
- Adjustable packing gland
- Bonus wing style T-handle
- Nuts and bolts
- HV Suffix = fits high velocity pumps



Part #	Mfg #	Size	WOG	Price
145019	40402	1/2"	600	
143756	40403	3/4"	600	
143760	40404	1"	600	
146935	40404HV	1"	600	
143761	40405	1-1/4"	600	
146936	40405HV	1-1/4"	600	
143762	40406	1-1/2"	600	
146937	40406HV	1-1/2"	600	
143763	40407HV	2"	600	

The Isolator® Uni-Flange Ball Valve (Swt x Flange)

- Full port forged brass ball valve
- Adjustable packing gland
- Bonus wing style T-handle
- Nuts and bolts
- HV Suffix = fits high velocity pumps



Part #	Mfg #	Size	WOG	Price
145020	50402	1/2"	600	
143768	50403	3/4"	600	
146938	50404HV	1"	600	
146939	50405HV	1-1/4"	600	
143771	50406	1-1/2"	600	
146940	50406HV	1-1/2"	600	
143773	50407HV	2"	600	

The Isolator® Uni-Flange Ball Valve with Rotating Flange (IPS x Rotating Flange)

- Full port forged brass ball valve
- Detachable rotating flange
- Adjustable packing gland
- Bonus wing style T-handle
- Nuts and bolts
- HV Suffix = fits high velocity pumps



Part #	Mfg #	Size	WOG	Price
143764	41403	3/4"	600	
143765	41404	1"	600	
146928	41404HV	1"	600	
143766	41405	1-1/4"	600	
146929	41405HV	1-1/4"	600	
146930	41406HV	1-1/2"	600	

The Isolator® Uni-Flange Ball Valve with Rotating Flange (Swt x Rotating Flange)

- Full port forged brass ball valve
- Detachable rotating flange
- Adjustable packing gland
- Bonus wing style T-handle
- Nuts and bolts
- HV Suffix = fits high velocity pumps



Part #	Mfg #	Size	WOG	Price
143774	51403	3/4"	600	
143775	51404	1"	600	
146931	51404HV	1"	600	
143776	51405	1-1/4"	600	
146932	51405HV	1-1/4"	600	
143777	51406	1-1/2"	600	
146934	51406HV	1-1/2"	600	

The Isolator® Uni-Flange Ball Valve with Drain and Rotating Flange (IPS x Rotating Flange)

- Full port forged brass ball valve
- Detachable rotating flange
- Multi-function hi-flow hose drain
- Adjustable packing gland
- Nuts and bolts
- HV Suffix = fits high velocity pumps



Part #	Mfg #	Size	WOG	Price
143778	41413	3/4"	600	

Isolation Flanges

**The Isolator® Uni-Flange Ball Valves
(Continued)**

The Isolator® Uni-Flange Ball Valve with Drain and Rotating Flange (IPS x Rotating Flange)

Part #	Mfg #	Size	WOG	Price
143779	41414	1"	600	
146941	41414HV	1"	600	
143780	41415	1-1/4"	600	
146942	41415HV	1-1/4"	600	
143781	41416	1-1/2"	600	
146943	41416HV	1-1/2"	600	

The Isolator® Uni-Flange Ball Valve with Drain and Rotating Flange (Swt x Rotating Flange)

- Full port forged brass ball valve
- Detachable rotating flange
- Multi-function hi-flow hose drain
- Adjustable packing gland
- Nuts and bolts
- HV Suffix = fits high velocity pumps



Part #	Mfg #	Size	WOG	Price
143782	51413	3/4"	600	
143783	51414	1"	600	
146944	51414HV	1"	600	
143784	51415	1-1/4"	600	
146945	51415HV	1-1/4"	600	
143785	51416	1-1/2"	600	
146946	51416HV	1-1/2"	600	

Heating - Hydronic Accessories

Isolation Flanges

Isolation Pump Flanges

IPF Series Isolation Pump Flange

- Isolate circulator pumps to facilitate circulator pump replacement or repairs
- Brass body and flange with bottom loaded blowout proof stem, chrome plated ball and double o-ring stem seal
- Pressure rated at 600 psi WOG



Part #	Mfg #	Model	Size	Price
076650	0068090	IPFM1-T	3/4"	
076651	0068091	IPFM1-T	1"	
076652	0068092	IPFM1-T	1-1/4"	
076657	0068095	IPFM1-S	3/4"	
076658	0068096	IPFM1-S	1"	
082649	0068097	IPFM1-S	1-1/4"	
120420	0068098	IPFM1-S	1-1/2"	

Low Water Cut-Offs & Feeders

Combination Water Feeder/Low Water Cut-Offs

47-2 Combination Mechanical Water Feeder/Low Water Cut-Offs

- For steam and hot water boilers with cold water feed
- Continuous maintenance of minimum safe water level, independent of electrical service
- Proportional feed action
- Quick hook-up fittings provided
- Maximum water supply pressure: 150 psi
- Maximum inlet water temperature: 120°F
- Maximum boiler pressure: 25 psi



Part #	Mfg #	Model #	Description	Price
007122	132800	47-2	No 2 Switch	

Low Water Cut-Offs & Feeders

Low Water Cut-Offs

Safgard™ LWCO for Steam Boilers

- No moving parts to wear or stick
- Time delay prevents short cycling
- SV Models include the shorter model EL-1214-SV probe suitable for mounting in standard reducing tees



Part #	Mfg #	Description	Price
097318	500-SV	24V, Manual Reset, Test Button	
097319	550-SV	120V, Manual Reset, Test Button	

Safgard™ Direct Boiler Mounting LWCO with Primary Cut-Offs

- Burner circuit contacts open after 15 second delay in low water condition
- Automatically restarts burner 30 second after water reaches probe
- For residential & commercial boilers to 15 psi
- SV Models include the shorter model EL-1214-SV probe suitable for mounting in standard reducing tees



Part #	Mfg #	Description	Price
097320	400-SV	24VAC, 2VA, SPDT 15 psi	

Automatic Water Feeders for Steam Boilers

- Delay before feed: 2 minutes
- Feed setting: LWCO
- Maximum steam pressure: 15 psi
- Maximum water supply pressure: 150 psi
- Maximum amp draw: 5A (24VAC), 2A (120VAC)



Part #	Mfg #	Description	Price
030223	VXT-24	1 gpm, 24V	

Low Water Cut-Offs & Feeders

Boiler Feed Water Backflow Preventers

Combination Backflow Preventer (9D) and Fill Valve (1156F) for Hot Water Boilers - 1/2"

- *Used on boiler feed lines to provide make up water to the boiler and prevent backflow when supply pressure falls below system pressure*
- *High capacity fast fill and purge capability*
- *Maximum pressure: 100 psi*
- *Maximum temperature: 212°F*
- *Suffix Options:*
 - 911 = NPT x NPT Connections



Part #	Mfg #	Model	Description	Price
041894	0386460	911M3	1156F+9D Combo	

Low Water Cut-Offs & Feeders

Pigtails

Pigtail Syphon

- For use with gauges on steam line
- 1/4" MPT x 1/4" MPT
- Steel construction

G60-000



G60-001

Part #	Mfg #	Description	Price
091486	G60-000	1/4" Straight	
091487	G60-001	1/4" 90° Angle	



Pressure Reducing Valves

Pressure Reducing Valves

- Fast fill feature
- Low inlet pressure check valve
- Convenient cleanable strainer
- Maximum operating temperature: 225°F
- Maximum operating pressure: 125 psig



Combination "Dual Units" Pressure Relief and Reducing Valve

- Relief valve pressure setting: 30 psi
- 1/2" NPT Boiler connection
- Brass/iron body construction

Part #	Mfg #	Model	Components - Relief Plus	Price
002470	110199	8	B-38	

Pressure Reducing Valve

- Brass body construction
- Pressure factory set to 12 psig
- Adjustable range: 10 - 25 psig

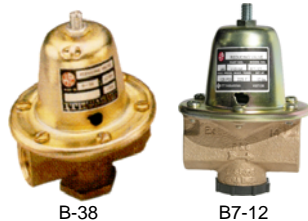

Part #	Mfg #	Model	Connection	Price
002402	110190	B-38	1/2" NPT	
002403	110196	B7-12	3/4" NPT	

Heating - Hydronic Accessories

Pressure Reducing Valves

Boiler Feed Water Pressure Regulators

Feed Water Pressure Regulator

- Built-in integral strainer
- Bronze body construction
- Tight seating check valve
- Maximum pressure: 100 psi
- Purge lever for manual purging
- NPT threaded inlet and outlet connections
- High capacity performance and simplified servicing design
- Suitable for use in the boiler feed lines of hydronic heating systems
- Provides make-up water to the system in the event of system leaks
- For use in commercial and residential hydronic heating systems to fill the boiler and piping system with water, and to maintain water pressure in the system at all times

Part #	Mfg #	Model	Size	Price
062991	0322825	N256	3/4"	

High Capacity Feed Water Pressure Regulator

- Iron and bronze body
- Tight seating check valve
- Purge lever for manual purging
- Stainless steel strainer
- Maximum pressure: 100 psi
- Provides make-up water to the system in the event of system leaks
- For use in commercial and residential hydronic heating systems to fill the boiler and piping system with water, and to maintain water pressure in the system at all times



Part #	Mfg #	Model	Inlet Size	Connection	Price
036375	0386425	1156F	1/2"	Threaded	

LFN55BM1-U Water Pressure Regulator

- Double union inlet & outlet connections
- Integral stainless steel strainer
- Thermoplastic seat
- Lead Free* brass body construction
- Serviceable in line
- Bypass feature controls thermal expansion pressure***
- Sealed spring cage on all models for accessible outdoor or pit installations



Part #	Mfg #	Model	Size	Price
180454	0009589	LFN55M1-U	3/4"	
180453	0009639	LFN55M1-U	1"	

LFX65B Water Pressure Regulator

- Cartridge Style valve
- Seat design reduces flow noise
- 100% balanced valve
- Full size range available rated to 400psi
- Cartridge Assemblies available in standard and high-pressure (HP) models
- Bypass feature in Cartridge Assembly controls thermal expansion pressure***.
- Standard construction includes sealed spring cage and corrosion resistant adjusting and cage screws for accessible outdoor or pit installations
- High performance thermoplastic integral seat cartridge
- Union connection and tailpiece kits for solder, Quick-Connect,
- PEX, CPVC and threaded to meet your commercial and residential applications.
- High temperature resistant reinforced diaphragm for hot water



Part #	Mfg #	Model	Size	Price
157025	0009949	LFX65BU	3/4"	
157026	0009970	LFX65BU	1"	

Pressure Reducing Valves

LFU5B-Z3 Water Pressure Regulator

- Union inlet connection
- Integral stainless steel strainer
- Replaceable seat module
- Lead Free* cast copper silicon alloy construction
- Serviceable in line
- Bypass feature controls thermal expansion pressure***
- High temperature resistant reinforced diaphragm for hot water
- Standard construction includes Z3 sealed spring cage and stainless steel corrosion resistant adjusting & cage screws for accessible outdoor or pit installations



LF26A Small Pressure Regulator 2-Way

- Rugged forged Lead Free* Brass body
- Tee handle adjustment
- Oversized orifice



Part #	Mfg #	Model	Size	Price
157268	0009811	LF26A	1/4"	
157269	0009815	LF26A	3/8"	
157270	0009819	LF26A	1/2"	

Part #	Mfg #	Model	Size	Price
157252	0009100	LFU5B-Z3	1/2"	
156599	0009118	LFU5B-Z3	3/4"	
157250	0009154	LFU5B-Z3	1"	
157253	0009180	LFU5B-Z3	1-1/4"	
158149	0009204	LFU5B-Z3	2"	
157256	0009108	LFU5B-LP-Z3	1/2"	

LF25AUB-Z3 Water Pressure Regulator

- Union inlet connection
- Integral stainless steel strainer
- Replaceable seat module
- Lead Free* cast copper silicon alloy construction
- Serviceable in line
- Bypass feature controls thermal expansion pressure***
- High temperature resistant reinforced diaphragm for hot water
- Standard construction includes Z3 sealed spring cage and stainless steel corrosion resistant adjusting & cage screws for accessible outdoor or pit installations
- (Spring -LP model only)



Part #	Mfg #	Model	Size	Price
158193	0009217	LF25AUB-Z3	1/2"	
156645	0009257	LF25AUB-Z3	3/4"	
156601	0009128	LF25AUB-LP-Z3	3/4"	
163080	0009309	LF25AUB-Z3	1"	
159642	0009431	LF25AUB-Z3	1-1/2"	
159058	0009465	LF25AUB-Z3	2"	

Heating - Hydronic Accessories

Radiator Traps & Valves

Radiator Valves

Brass Steam Radiator Globe Valve

- *Angled with ground joint union nut and tailpiece*
- *60 psi/15 WSP*



Part #	Mfg #	Size	Price
148415	11534	1" IPS	
148416	11535	1-1/4" IPS	

Brass Hot Water Radiator Globe Valve

- *Angled with ground joint union nut and tailpiece*
- *60 psi*



Part #	Mfg #	Size	Price
143811	11553	3/4" IPS	
143813	11554	1" IPS	
143814	11555	1-1/4" IPS	
143816	11556	1-1/2" IPS	

Heating - Hydronic Accessories

Radiator Traps & Valves

PRO-PAL® Series Valves

PRO-PAL® Expansion Tank Pro Service Valve™
(FIP x MIP x FIP x Hose)

- Full port forged brass ball valve with hi-flow hose drain



Part #	Mfg #	Size	WOG	Price
143788	41672	1/2"	600	

Radiator Traps & Valves

Radiator Steam Traps

**Series 17C Balanced Pressure BearTrap®
Thermostatic Steam Trap**

- For institutional, commercial, and residential heating system applications where low or moderate water hammer may occur
- Subcooling
- Replaceable Dura-Stat® module
- Stainless steel components
- Resistant to moderate water hammer and chemical attack
- Maximum operating pressure: 25 psig
- 3-Year warranty



Part #	Mfg #	NPT Size	Description	Price
005399	401536	1/2"	Angle	

Heating - Hydronic Accessories

Radiator Traps & Valves

Hydronics - Steam Valves

RA Series Steam Radiator Valve (FNPT x MNPT Union)

- Teflon® stem packing



RA-1-AP Angle - Bronze Body

Part #	Mfg #	Model	Size	Price
036349	0067450	RA1AP	1/2"	
036350	0067451	RA1AP	3/4"	
036353	0067453	RA1AP	1-1/4"	
036354	0067454	RA1AP	1-1/2"	

Bronze Union Radiator Elbows

- For use in steam and hot water systems
- Maximum working pressure: 60 psi (non-shock) for hot water, 15 psi (non-shock) for saturated steam



Part #	Mfg #	Model	Size	Price
072758	0067460	UL-1	1/2" FIP x M Union	
031791	0067461	UL-1	3/4" FIP x M Union	



Spiralink Couplings

Spiralink® Couplers

Part #	Mfg #	Description	Price
010269	10010	Spiralink Coupler	

Thermal Expansion Tanks

Thermal Expansion Tanks

Therm-X-Trol® ASME Diaphragm Thermal Expansion Tank

- For use with potable water heaters only
- Non-ASME
- Pre-pressurized, diaphragm type
- Drawn steel domes, welded steel construction
- Rigid polypropylene liner
- Butyl diaphragm, diaphragm hoop ring mechanically grooved for permanent air-tight seal
- Stainless steel system connection
- Maximum operating system: 200°F
- Maximum working pressure: 150 psig
- Factory pre-charge: 40 psig
- 5-Year limited warranty



Therm-X-Trol® ASME Diaphragm In-Line Thermal Expansion Tank

Part #	Mfg #	Dia	Height	Volume	Price
024594	ST-5-C	10"	10-3/8"	2.1 gal	
028941	ST-12-C	12"	13-3/8"	6.4 gal	

Therm-X-Trol® ASME Diaphragm Vertical Stand Thermal Expansion Tank

- Stainless steel system connection
- Maximum operating temperature: 200°F
- Factor pre-charge: 55 psig

Part #	Mfg #	Dia	Height	Volume	Price
029837	ST-20V-C	12"	19"	8.0 gal	
029838	ST-30V-C	16"	19"	14.0 gal	
029839	ST-42V-C	16"	24"	18.0 gal	
029840	ST-60V-C	16-1/4"	34"	25.0 gal	
113382	ST-70V-C	16"	45"	34.0 gal	
030098	ST-80V-C	24"	37"	53.0 gal	

Extrol Thermal Expansion Tank

- For use with closed hydronic heating and cooling systems
- Both space and energy saving
- Butyl/EPDM diaphragm
- Air separation design eliminates absorption of system air



Part #	Mfg #	Dia	Height	Volume	Price
002008	15	8"	12-5/8"	2.0 gal	

Thermal Expansion Tanks (Continued)

Extrol Thermal Expansion Tank

Part #	Mfg #	Dia	Height	Volume	Price
002009	30	11"	15-1/2"	4.4 gal	
002016	60	11"	23"	7.6 gal	
021243	90	15-3/8"	21"	14.0 gal	

Standard Expansion Tanks

Extrol® Vertical AX Series Expansion Tank

- Carbon steel shell construction with red oxide primer
- Diaphragm design
- Factory pre-charge: 12 psig
- Operating temperature: 240°F



Part #	Mfg #	Dia	Length	Volume	Price
052098	AX15V	12"	20"	8.0 gal	
048739	AX40V	16"	30"	21.7 gal	

SX Extrol® Vertical Boiler System Expansion Tank

- Factory pre-charge: 12 psig
- Maximum working pressure: 100 psig
- Maximum operating temperature: 240°F



Part #	Mfg #	Dia	Height	Volume	Price
001999	SX-30V	15"	25"	14.0 gal	
002000	SX-40V	15"	32"	20.0 gal	
002001	SX-60V	15"	48"	32.0 gal	
024728	SX-90V	22"	36"	44.0 gal	
101641	SX-160V	26"	47"	86.0 gal	

Thermal Expansion Tanks

Special Application Expansion Tanks

Radiant Extrol® Expansion Tank

- For high-efficiency radiant systems
- Plastic liner is compatible with barrier and non-barrier tubing
- Suitable for use in glycol applications
- Non-ferrous system connection for corrosion resistance
- Factory pre-charged: 12 psig
- Maximum working pressure: 100 psig
- Maximum operating temperature: 200°F

Part #	Mfg #	Dia	Height	Volume	Price
090481	RX-15	8"	13"	2.0 gal	
090482	RX-30	11"	16"	4.4 gal	
090483	RX-60	15"	19"	10.3 gal	

FT Fill-Trol® System Expansion Tank

- Eliminates the need for a separate, automatic fill valve
- Tank pressure controls system fill
- Factory pre-charged: 12 psig
- Fully adjustable up to a maximum working pressure of 100 psig
- Air purger not included



Part #	Mfg #	Dia	Height	Volume	Price
002002	109	8"	13"	2.0 gal	
002004	110	11"	16"	4.4 gal	

Fill-Trol® Expansion Tank Valve

Part #	Mfg #	Air Purger	Price
002003	109-15	Fill-Trol® Valve	

Water Gauges & Sight Glasses

Water Gauges

20 Series Standard Pattern Bronze Water Gauge - Standard Gauge

- Use for all types of liquid level verification
- EPDM Gauge glass gaskets standard
- Equipped with (2) copper guard rods
- Standard 1/4" needle drain valve in lower arm
- CRN Registered
- Rated: 125 psig @ 350°F, 300 psig @ 100°F



Part #	Mfg #	Pipe Size	Glass OD/Length	Wheel Type	Price
003018	20-104-00	1/2"	5/8" x 12"	Aluminum	

20-200 Series Heavy Pattern Bronze Water Gauge- Standard Gauge

- Heavy valve body pattern for higher service ratings
- Rated 200 psig @ 400°F, 400 psig @ 100°F subject to pressure/temperature ratings of gauge glass



Part #	Mfg #	Pipe Size	Glass OD/Length	Wheel Type	Price
003019	20-204-00	1/2"	5/8" x 12"	Aluminum	

Water Gauge Components

Regular Gauge Glass

Part #	Mfg #	Size	Price
004899	9858R08	5/8" x 8"	
004892	9858R12	5/8" x 12"	
004897	9858R30	5/8" x 30"	

Heating - Hydronic Accessories



Water Gauges & Sight Glasses

Gauge Glasses & Accessories

Gray Cut Gauge Glass Gasket

- Synthetic rubber



Part #	Mfg #	Size	Price
006253	881	9/16" x 13/16" x 5/16"	

Heating - Hydronic Accessories

Water Gauges & Sight Glasses

TruFLOW™ Classic Specific Accessories

- Use Uponor Silicone Oil (A2620007 - sold separately) on male threads to ease installation

TruFLOW™ Visual Flow Meter

- Can be used on TruFLOW Jr. and TruFLOW Classic manifolds to accurately measure the flow of hydronic radiant loops



Part #	Mfg #	Description	Price
113670	A2640027	0.25 To 2.0 gpm	

Zone Valves

Hydronic Motorized Zone Valves

V8043/V8044 Low Voltage Hydronic Zone Valves

2-Position Normally Closed Straight-Through Valve with End Switch

- For controlling flow of hot and cold water, valve closes when de-energized
- Manual opener included
- With 18" wire leads and auxiliary switch
- Voltage: 24V, 50/60Hz

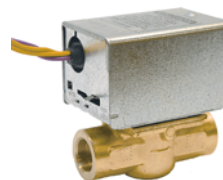

Part #	Mfg #	Pipe Size	Capacity	Max Close-Off Pressure	End Switch	Electrical Connections	Price
006823	V8043E1012	3/4" Swt	3.5 Cv	20 psi	SPST	18" Leads	
006824	V8043E1061	3/4" Swt	8 Cv	8 psi	SPST	18" Leads	
006825	V8043E1079	1" Swt	8 Cv	8 psi	SPST	18" Leads	
081700	V8043E1145	3/4" NPT	3.5 Cv	20 psi	SPST	18" Leads	

2-Position Normally Closed Straight-Through Motorized Valve

- For controlling flow of hot and cold water
- With end switch, screw terminals and manual opener
- Terminal board with (5) terminals
- Maximum ambient temperature: 125°F
- Electrical connections: screw terminal block
- Voltage: 24V, 50/60Hz



Part #	Mfg #	Pipe Size	Capacity	Max Close-Off Pressure	End Switch	Type	Price
006826	V8043F1036/U	3/4" Swt	3.5 Cv	20 psi	SPST	2-Way Straight Thru	

5000 Series QuickFit® 2-Position Two-Way, Straight-Through Motorized Valve

- On-off and 2-way low voltage valves consist of an actuator and valve assembly
- For controlling flow of hot water and some models steam
- Includes end switch and manual opener
- Terminal board
- Maximum ambient temperature: 125°F
- Static pressure: 300 psi
- Voltage: 24V @ 60Hz



Part #	Mfg #	Pipe Size	Capacity	Max Close-Off Pressure	End Switch	Electrical Connections	Price
094300	V8043E5061	3/4" Swt	8.0 Cv	8 psi	SPST	18" Leads	
094301	V8043E5079	1" Swt	8.0 Cv	8 psi	SPST	18" Leads	
094302	V8043F5036	3/4" Swt	3.5 Cv	20 psi	SPST	Terminal Block	

Heating - Hydronic Accessories

Zone Valves

V8044A 2-Position Diverting Motorized Valve

- For controlling flow of hot water
- 1/2" Bottom inlet
- Manual opener
- Maximum ambient temperature: 125°F
- Voltage: 24V, 50/60Hz



Part #	Mfg #	Pipe Size	Capacity	Max Close-Off Pressure	End Switch	Electrical Connections	Price
006827	V8044E1011	3/4" Swt	7.0 Cv	10 psi	SPST	18" Leads	

Zone Valves

Zone Valves

Whisper Guard Geothermal Valves

- Pump head: 150 feet of water
- Maximum working pressure: 125 psi
- Temperature range: 40-240°F
- Amperature rating: 0.9
- Volt frequency: 24V 60Hz
- 3-Year head, 5-year body warranty



Part #	Mfg #	Connection Size	Normal Flow Range	Pressure Drop Thru Valve Equivalent Feet of Pipe	Price
101957	5101-G2	3/4" Threaded	2 Way	125	

Zone Sentry® Zone Valve

- Provides on-off, normally open or normally closed control in both open and closed hot or chilled water systems
- Utilizes microcircuit based logic to control a gear driven electronic actuator which drives a ball valve based body design
- Uses up to 93% less energy than other commonly installed zone valves
- Quiet actuator operation
- Suitable for condensing environments
- Universal installation orientation
- Up to 12 valves on (1) 40VA transformer
- Multi-function LED assists with troubleshooting
- Quick release actuator mounting clips
- Positional indicator shows the ball valve's actual position
- Easy to wire quick connections
- Bi-directional flow (you cannot install the valve backwards)
- The actuator mounts on the valve in either direction
- Shut-off pressure: 125 psi
- Manual override button
- e-smart Energy saving



Heating - Hydronic Accessories

Part #	Mfg #	Description	Price
136624	Z075C2	2-Way, 3/4" Swt	
135892	Z100C2	2-Way, 1" Swt	

Zone Valve Power Head

555-050RP



Part #	Mfg #	Description	Price
010361	555-050RP	Power Unit Assembly, Snap Action Switch	
010362	555-173RP	Replacement Head	
074288	ZA024Q4A1	NO/NC Replacement Motorized Zone Valve Power Head	

Zone Valves

Zone Valves

Hydronic Zone Control

- Self aligning barrel-type valve stem uses line pressure to seal off binding on opening and closing
- Valve stem made of stainless steel
- Built-in auxiliary contacts to control burner or circulator relay



3-Wire, 24V Valve with Screw Terminal Wiring Panel & Auxiliary Switch

Part #	Mfg #	Tubing Size (ID)	24V AC Thermostat Circuit Rating	Time Cycle Open/Close	Price
012074	1311-102	3/4"	0.2A	45 Sec/45 Sec	
012072	1311-103	1"	0.2A	45 Sec/45 Sec	

2-Wire, 24V Valve with Screw Terminal Wiring Panel & Auxiliary Switch

Part #	Mfg #	Tubing Size (ID)	24V AC Thermostat Circuit Rating	Time Cycle Open/Close	Price
012075	1361-104	1-1/4"	0.2A	45 Sec/60 Sec	

Heating - Hydronic Accessories



JOHN J. MORGAN CO.



JOHN J. MORGAN CO.

Reznor Infrared Accessories

Reznor Parts

Part #	Mfg #	Description	Price
066083	Rezbrkt	Low Ceiling Mounting Bracket	

Heating - Infrared

Schwank Infrared Heating

Tube Heaters

Builder Schwank Tube Heater

- Line voltage thermostat ready
- Simple relay option for 24V thermostat
- Reflector & end caps improve IR heat output
- Swing-down cabinet service access
- Whisper quiet ceramic burner



Part #	Mfg #	Capacity	Fuel	Length	Price
129056	S100-45-10	45	NG	10'	
129084	S100-45-20	45	NG	20'	
129085	S100-60-20	60	NG	20'	
129087	S100-60-30	60	NG	30'	
129088	S100-80-20	80	NG	20'	
129089	S100-80-30	80	NG	30'	
129090	S100-80-40	80	NG	40'	
129092	S100-100-20	100	NG	20'	
129093	S100-110-30	110	NG	30'	
129094	S100-110-40	110	NG	40'	
129095	S100-110-50	110	NG	50'	
129096	S100-130-30	130	NG	30'	
129098	S100-130-40	130	NG	40'	
129099	S100-130-50	130	NG	50'	
129101	S100-155-40	155	NG	40'	
129102	S100-155-50	155	NG	50'	
129103	S100-155-60	155	NG	60'	
129104	S100-175-50	175	NG	50'	
136923	S100-175-50L	175	LP	50'	
129106	S100-175-60	175	NG	60'	
137376	S100-175-60L	175	LP	60'	
129107	S100-175-70	175	NG	70'	
129109	S100-200-50	200	NG	50'	
129111	S100-200-60	200	NG	60'	
129112	S100-200-70	200	NG	70'	

Set Series WisperJet Two-Stage Tube Heater

- 2-Stage burner operation
- Status indicator lights
- Straight tube or "U" tube configuration
- Swing-down cabinet service access
- Whisper quiet ceramic burner



Part #	Mfg #	Capacity	Fuel	Length	Price
129932	SET 80/60	80/60	NG	20'	
129933	SET 80/60	80/60	NG	30'	

Tube Heaters (Continued)

Set Series WisperJet Two-Stage Tube Heater

Part #	Mfg #	Capacity	Fuel	Length	Price
129937	SET 110/75	110/75	NG	30'	
129940	SET 110/75	110/75	NG	40'	
129941	SET 130/90	130/90	NG	30'	
129942	SET 130/90	130/90	NG	40'	
129943	SET 155/110	155/110	NG	40'	
129944	SET 155/110	155/110	NG	50'	
129945	SET 175/125	175/125	NG	50'	
129947	SET 200/140	200/140	NG	50'	
129948	SET 200/140	200/140	NG	60'	

PremierSchwank Tube Heater

- Line voltage or 24V thermostat ready
- Status indicator lights
- Power cord with plug
- 4" Bird screened combustion air collar
- Swing-down cabinet service access
- Whisper quiet ceramic burner
- 'Focus shield' reflector and end caps for Premier IR heat output
- Emissive coated radiant tubes



Part #	Mfg #	Capacity	Fuel	Length	Price
135859	STS-JZ-45-10	45	NG	10'	
143710	STS-JZ-80-30	80	NG	30'	
143292	STS-JZ-80-40	80	NG	40'	
136504	STS-JZ-110-40	110	NG	40'	
143912	STS-JZ-110-50	110	NG	50'	
143914	STS-JZ-130-40	130	NG	40'	
136509	STS-JZ-130-50	130	NG	50'	
136967	STS-JZ-155-60	155	NG	60'	
143920	STS-JZ-200-50	200	NG	50'	
143923	STS-JZ-200-70	200	NG	70'	

Tube Heater Accessories

Burner Kit

Part #	Mfg #	Description	Price
129916	JS-080T-BN	NG Burner Kit for SET 80/60	
129918	JS-155T-BN	NG Burner Kit for SET 155/110	
129920	JS-200T-BN	NG Burner Kit for SET 200/140	
137325	JS-110P-BN	NG Burner Kit for STW-JZ-110	
144704	JS-130P-BN	NG Burner Kit for STW-JZ-130	

Heating - Infrared

Schwank Infrared Heating

Tube Heater Accessories (Continued)

Burner Kit

Part #	Mfg #	Description	Price
128974	JS-E045-BN	NG Burner Kit for S100 45	
128980	JS-E060-BN	NG Burner Kit for S100 60	
128981	JS-E080-BN	NG Burner Kit for S100 80	
128982	JS-E100-BN	NG Burner Kit for S100 100	
128983	JS-E110-BN	NG Burner Kit for S100 110	
128984	JS-E130-BN	NG Burner Kit for S100 130	
128985	JS-E155-BN	NG Burner Kit for S100 155	
128986	JS-E175-BN	NG Burner Kit for S100 175	
136851	JS-E175-BL	LP Burner Kit for S100 175	
128987	JS-E200-BN	NG Burner Kit for S100 200	
136171	JS-R045-AN	NG Burner Kit for STR-JZ-45	
136501	JS-S110-AN	NG Burner Kit for STS-JZ-110	
136505	JS-S130-AN	NG Burner Kit for STS-JZ-130	
136965	JS-S155-AN	NG Burner Kit for STS-JZ-155	

Tube Kit

- Stand-alone tube kits require no additional tube kits
- Primary tube kits require at least one additional secondary tube kit
- Secondary tube kits require a primary tube kit
- Kits include:
 - Tubes
 - Reflectors
 - Hanger
 - Tube couplers

Part #	Mfg #	Description	Price
128988	TM-4510-SX	10' Stand-Alone Kit for S100-45	
135829	TS-4510-JZ	10' Stand-Alone Kit for STR-JZ-45	
128990	TM-1020-SX	20' Stand-Alone Kit for S100-100	
128989	TM-1420-SX	20' Stand-Alone Kit for SET80/60	
136172	TS-1420-JZ	20' Stand-Alone Kit for STR-JZ-45 & 60	
128991	TM-1430-SX	30' Stand-Alone Kit for SET80/60, 110/75, & 130/90	
128992	TM-1040-SX	40' Stand-Alone Kit for SET110/75, 130/90, & 155/110	
136502	TS-1040-JZ	40' Stand-Alone Kit for STS-JZ-80/110/130/155	
128994	TM-1030-SX	30' Primary Kit for SET175/125 & 200/140	
128993	TM-F030-SX	30' Primary Kit for SET155/110	
136506	TS-F030-JZ	30' Primary Kit for STS-JZ-110/130/155	

Tube Heater Accessories (Continued)

Tube Kit

Part #	Mfg #	Description	Price
137323	TW-F030-JZ	30' Primary Kit for SPW/STW-JZ-110/130/155	
128999	TM-1010-SX	10' Secondary Kit for S100	
128996	TM-0020-SX	20' Secondary Kit for SET	
128997	TM-0030-SX	30' Secondary Kit for SET	
136507	TS-0020-JZ	20' Secondary Kit for STS-JZ	
137324	TW-0020-JZ	20' Secondary Kit for SPW-JZ or STW-JZ	
136966	TS-0030-JZ	30' Secondary Kit for STS-JZ	
128998	TM-0040-SX	40' Secondary Kit for S100	

LP Conversion Kit

Part #	Mfg #	Description	Price
129000	JS-0556-XE	45 MBTUH NG to LP	
129001	JS-0557-XX	60 MBTUH NG to LP	
129002	JS-0559-XX	80/60 MBTUH NG to LP	
129847	JS-0555-TG	110/75 MBTUH NG to LP	
171260	JS-0563-XB	125 MBTUH NG to LP	
129929	JS-0555-TK	130/90 MBTUH NG to LP	
129930	JS-0555-TO	155/110 MBTUH NG to LP	
129129	JS-0565-XX	155 MBTUH NG to LP	

Heating - Infrared

Adjustable Pressure Switches

2374 Series Adjustable Air Pressure Sensing Switches

- Designed to replace a wide variety of air-sensing switches found in residential & light commercial applications including furnaces, electronic air cleaners & humidifiers
- SPDT Switching that can be actuated by positive or negative pressure, or by pressure differential
- Highly accurate, practically insensitive to temperature change
- Operating temperature range: -40° to 190°F
- Electrical connections: 1/4" spade
- Air sample line connectors: will accept 1/8", 1/4" or 3/8" tubing
- UL & CSA Approved
- Includes mounting hardware and adjustment tool



HVAC - General Accessories

Part #	Mfg #	Description	Price
044313	2374-495	.25" to 1.0"wc Set Point Range, SPDT Switching	
044314	2374-498	.10" to 4.0"wc Setpoint Range, SPDT Switching	

Capacitors

Capacitors

SwitchCap™ Dual Multiple Value Capacitor

- (1) Unit covers most HVAC applications
- Capacitance value are selected by built-in switches, no jumpers to get lost or connected improperly
- Rugged PC-ABS housing can't corrode like metal can caps and offers superior insulation resistance
- Epoxy encapsulated – superior resistance to moisture and vibration
- Built-in hang tabs-easy mounting with sheet metals screws
- Easy set-up, (8) switches select (128) values
- Ranges:
 - Fan 3.0 to 10.5 mfd 450VAC
 - Herm 15 to 60 mfd 450VAC



HVAC - General Accessories

Part #	Mfg #	Description	Price
150840	SCAP-60D	450VAC RMS Continuous @ 50/60Hz	

370VAC Single Oval Run Capacitors

- Rated Frequency: 50/60 Hz
- Applied Standard: UL-810; CSA22.2 No190, IEC60252
- Meets 10,000AFC safety requirement per UL-810
- Capacitance Tolerance +/-5%
- Permissible Temperature: -40°C to +70°C
- Individually Packaged
- Withstanding Voltage test
- Between Terminals: Rated Voltage X 1.75VAC, 10sec
- Between Terminals and Case: Rated Voltage X 2+1000VAC, 60sec
- Maximum Permissible Voltage: 110% of the rated voltage
- Maximum Permissible Current: 130% of the rated current
- Oil Filled; Non PCB
- 1/4" quick connect terminal



Part #	Mfg #	Description	Price
195226	37-125H	370VAC Oval 12.5µF	

Capacitors

HVAC - General Accessories

370VAC Dual Oval Run Capacitor

- Rated Frequency: 50/60 Hz
- Capacitance Tolerance -5% - +5%
- Permissible Temperature: -40°C - +70°C
- Individually Packaged
- Withstanding Voltage test
- Between Terminals: Rated Voltage X 1.75VAC, 10sec
- Between Terminals and Case: Rated Voltage X 2+1000VAC, 60sec
- Maximum Permissible Voltage: 110% of the rated voltage
- Maximum Permissible Current: 130% of the rated current
- Applied Standard: UL-810; CSA22.2 No190, IEC60252
- Meets 10,000AFC safety requirement per UL-810
- Oil Filled; Non PCB
- Quick Connect Terminal - Faston #250 series size



Part #	Mfg #	Description	Price
195756	3GJ7530	370VAC Oval 30+7.5µF	
214443	3GJ0515	370VAC Oval 15+5µF	

370VAC Dual Round Run Capacitor

- Rated Frequency: 50/60 Hz
- Applied Standard: UL-810; CSA22.2 No190, IEC60252
- Meets 10,000 AFC safety requirement per UL-810
- Capacitance Tolerance +/-5%
- Permissible Temperature: -40°C to +70°C
- Individually Packaged
- Withstanding Voltage test
- Between Terminals: Rated Voltage X 1.75VAC, 10sec
- Between Terminals and Case: Rated Voltage X 2+1000VAC, 60sec
- Maximum Permissible Voltage: 110% of the rated voltage
- Maximum Permissible Current: 130% of the rated current
- Oil Filled; Non PCB
- 1/4" quick connect terminal



Part #	Mfg #	Description	Price
195759	3GR0525	370VAC Round 25+5µF	
197632	3GR0580	370VAC Round 80+5µF	

Capacitors

440VAC Single Oval Run Capacitors

- Rated Frequency: 50/60 Hz
- Applied Standard: UL-810; CSA22.2 No190, IEC60252
- Meets 10,000AFC safety requirement per UL-810
- Capacitance Tolerance +/-5%
- Permissible Temperature: -40°C to +70°C
- Individually Packaged
- Withstanding Voltage test
- Between Terminals: Rated Voltage X 1.75VAC, 10sec
- Between Terminals and Case: Rated Voltage X 2+1000VAC, 60sec
- Maximum Permissible Voltage: 110% of the rated voltage
- Maximum Permissible Current: 130% of the rated current
- Oil Filled; Non PCB
- 1/4" quick connect terminal



HVAC - General Accessories

Part #	Mfg #	Description	Price
202161	45030H	440VAC Oval 3µF	
204347	45040H	440VAC Oval 4µF	
201308	45050H	440VAC Oval 5µF	
211592	45050HU	440VAC Oval 5µF USA	
197360	45075H	440VAC Oval 7.5µF	
211593	45075HU	440VAC Oval 7.5µF USA	
197361	45100H	440VAC Oval 10µF	
211594	45100HU	440VAC Oval 10µF USA	
197362	45125H	440V Oval 12.5µF	
211602	45125HU	440VAC Oval 12.5µF USA	
197363	45150H	440VAC Oval 15µF	
211595	45150HU	440VAC Oval 15µF USA	
211596	45200HU	440VAC Oval 20µF USA	
211597	45250HU	440VAC Oval 25µF USA	
211598	45300HU	440VAC Oval 30µF USA	
211600	45400HU	440VAC Oval 40µF USA	
211601	45450HU	440VAC Oval 45µF USA	
211603	45500HU	440VAC Oval 50µF USA	
211614	45600HU	440VAC Oval 60µF USA	
210278	45700H	440VAC Oval 70µF USA	

Capacitors

HVAC - General Accessories

440VAC Single Round Run Capacitor

- Rated Frequency: 50/60 Hz
- Applied Standard: UL-810; CSA22.2 No190, IEC60252
- Meets 10,000AFC safety requirement per UL-810
- Capacitance Tolerance +/-5%
- Permissible Temperature: -40°C to +70°C
- Individually Packaged
- Withstanding Voltage test
- Between Terminals: Rated Voltage X 1.75VAC, 10sec
- Between Terminals and Case: Rated Voltage X 2+1000VAC, 60sec
- Maximum Permissible Voltage: 110% of the rated voltage
- Maximum Permissible Current: 130% of the rated current
- Oil Filled; Non PCB
- 1/4" quick connect terminal



Part #	Mfg #	Description	Price
198900	45150R	440VAC Round 15µF	
198901	45200R	440VAC Round 20µF	
198902	45250R	440VAC Round 25µF	
198903	45300R	440VAC Round 30µF	
198904	45350R	440VAC Round 35µF	
198905	45400R	440VAC Round 40µF	
198906	45450R	440VAC Round 45µF	
198907	45500R	440VAC Round 50µF	
198908	45550R	440VAC Round 55µF	
198909	45600R	440VAC Round 60µF	
198910	45800R	440VAC Round 80µF	

440VAC Dual Oval Run Capacitor

- Rated Frequency: 50/60 Hz
- Applied Standard: UL-810; CSA22.2 No190, IEC60252
- Meets 10,000AFC safety requirement per UL-810
- Capacitance Tolerance +/-5%
- Permissible Temperature: -40°C to +70°C
- Individually Packaged
- Withstanding Voltage test
- Between Terminals: Rated Voltage X 1.75VAC, 10sec
- Between Terminals and Case: Rated Voltage X 2+1000VAC, 60sec
- Maximum Permissible Voltage: 110% of the rated voltage
- Maximum Permissible Current: 130% of the rated current
- Oil Filled; Non PCB
- 1/4" quick connect terminal



Part #	Mfg #	Description	Price
202163	4JJ0530	440VAC Oval 5+30µF	
202164	4JJ0535	440VAC Oval 5+35µF	
202165	4JJ0540	440VAC Oval 5+40µF	
202166	4JJ7535	440VAC Oval 7.5+35µF	

Capacitors

440VAC Dual Round Run Capacitor

- Rated Frequency: 50/60 Hz
- Applied Standard: UL-810; CSA22.2 No190, IEC60252
- Meets 10,000AFC safety requirement per UL-810
- Capacitance Tolerance +/-5%
- Permissible Temperature: -40°C to +70°C
- Individually Packaged
- Withstanding Voltage test
- Between Terminals: Rated Voltage X 1.75VAC, 10sec
- Between Terminals and Case: Rated Voltage X 2+1000VAC, 60sec
- Maximum Permissible Voltage: 110% of the rated voltage
- Maximum Permissible Current: 130% of the rated current
- Oil Filled; Non PCB
- 1/4" quick connect terminal



HVAC - General Accessories

Part #	Mfg #	Description	Price
197358	4JR0525	440VAC Round 25+5 µF	
211604	4JR0525U	440VAC Round 25+5 µF USA	
196431	4JR0530	440VAC Round 5+30 µF	
211605	4JR0530U	440VAC Round 5+30 µF USA	
196433	4JR0535	440VAC Round 5+35 µF	
211606	4JR0535U	440VAC Round 5+35 µF USA	
196434	4JR0540	440VAC Round 5+40 µF	
211607	4JR0540U	440VAC Round 5+40 µF USA	
196435	4JR0545	440VAC Round 5+45 µF	
211609	4JR0545U	440VAC Round 5+45 µF USA	
196436	4JR0550	440VAC Round 5+50 µF	
211611	4JR0550U	440VAC Round 5+50 µF USA	
196437	4JR0555	440VAC Round 5+55 µF	
211612	4JR0555U	440VAC Round 5+55 µF USA	
196438	4JR0560	440VAC Round 5+60 µF	
211613	4JR0560U	440VAC Round 5+60 µF USA	
224820	4JR0570	440VAC Round 5+70 µF	
213845	4JR1080	440VAC Round 10+80 µF	
197359	4JR7530	440VAC Round 7.5+30 µF	
196439	4JR7535	440VAC Round 7.5+35 µF	
196440	4JR7540	440VAC Round 7.5+40 µF	
211608	4JR7540U	440VAC Round 7.5+40 µF USA	
196441	4JR7545	440VAC Round 7.5+45 µF	
211610	4JR7545U	440VAC Round 7.5+45 µF USA	
201867	4JR7550	440VAC Round 7.5+50 µF	
204184	4JR7555	440VAC Round 7.5+55 µF	
204147	4JR7560	440VAC Round 7.5+60 µF	
224819	4JR7570	440VAC Round 7.5+70 µF	

Capacitors

HVAC - General Accessories

Capacitors

Dual Round Capacitor



Part #	Mfg #	Microfarad	Volts	Price
103724	43-25133-01	25/3mfd	370V	
078956	43-25133-02	30/3mfd	370V	
096155	43-25133-21	30/5mfd	370V	
096131	43-25133-03	35/3mfd	370V	
096156	43-25133-35	35/5mfd	370V	
086414	43-25133-04	40/3mfd	370V	
096698	43-25133-22	40/5mfd	370V	
086403	43-25133-05	45/3mfd	370V	
086404	43-25133-06	45/5mfd	370V	
113731	43-26261-48	45/10mfd	370V	
086405	43-25133-07	50/3mfd	370V	
078757	43-25133-25	50/5mfd	370V	
142501	43-25133-28	55/3mfd	370V	
086406	43-25133-08	55/5mfd	370V	
096159	43-25133-29	55/10mfd	370V	
086409	43-25133-09	60/3mfd	370V	
036187	43-25133-10	60/5mfd	370V	
103773	43-25133-31	60/10mfd	370V	
086411	43-25133-32	70/5mfd	370V	
103775	43-26271-47	70/10mfd	370V	
080910	43-25133-33	80/5mfd	370V	
096161	43-25133-34	80/10mfd	370V	
086340	43-25133-11	35/3mfd	440V	
087300	43-25133-12	35/5mfd	440V	
072615	43-25133-14	40/5mfd	440V	
133921	43-25133-16	45/5mfd	440V	
133922	43-25133-26	50/5mfd	440V	
072616	43-25133-17	55/5mfd	440V	
086410	43-25133-30	60/5mfd	440V	
096160	43-26271-45	60/10mfd	440V	

Dual Oval Capacitor

- Certified to the highest level of UL 810
- Tested and approved for 5,000 AFC



Part #	Mfg #	Microfarad	Volts	Price
063489	43-25135-03	35/5mfd	370V	

Capacitors (Continued)

Dual Oval Capacitor

Part #	Mfg #	Microfarad	Volts	Price
098888	43-25135-19	40/3mfd	370V	

Single Round Capacitor



Part #	Mfg #	Microfarad	Volts	Price
142502	43-25136-01	3mfd	370V	
142503	43-25136-02	4mfd	370V	
142505	43-25136-03	5mfd	370V	
142506	43-25136-04	6mfd	370V	
082669	43-25136-05	7.5mfd	370V	
094857	43-25136-06	10mfd	370V	
094858	43-25136-07	12.5mfd	370V	
074119	43-25136-08	15mfd	370V	
094861	43-25136-09	20mfd	370V	
142509	43-25136-10	25mfd	370V	
125108	43-25136-11	30mfd	370V	
095766	43-25136-12	35mfd	370V	
105798	43-25136-13	40mfd	370V	
142513	43-25136-15	55mfd	370V	
142514	43-25136-16	60mfd	370V	
113922	43-25136-18	80mfd	370V	
142515	43-25136-19	90mfd	370V	
132363	43-25136-32	40mfd	440V	
117432	43-25136-33	45mfd	440V	
142512	43-25136-34	50mfd	440V	

Single Oval Capacitor



Part #	Mfg #	Microfarad	Volts	Price
022868	43-25134-01	3mfd	370V	
058909	43-25134-27	4mfd	370V	
022869	43-25134-02	5mfd	370V	
141512	43-25134-28	6mfd	370V	
017773	43-25134-03	7.5mfd	370V	
020049	43-25134-04	10mfd	370V	

Capacitors

Capacitors (Continued)
Single Oval Capacitor

Part #	Mfg #	Microfarad	Volts	Price
020740	43-25134-05	12.5mfd	370V	
030139	43-25134-06	15mfd	370V	
141513	43-25134-07	20mfd	370V	
141515	43-25134-09	30mfd	370V	
141516	43-25134-10	35mfd	370V	
141517	43-25134-12	40mfd	370V	
141518	43-25134-17	45mfd	370V	
141519	43-25134-18	50mfd	370V	
141520	43-25134-19	55mfd	370V	
141521	43-25134-29	60mfd	370V	
141522	43-25134-30	70mfd	370V	
141523	43-25134-31	80mfd	370V	

Start Capacitor

- Phenolic case
- 15 Ohm Bleed resistor



Part #	Mfg #	Microfarad	Volts	Price
009293	43-17075-03	135-155mfd	330V	
009294	43-17075-04	88-106mfd	330V	
009295	43-17075-05	189-227mfd	330V	
024251	43-17075-07	270-324mfd	330V	

HVAC - General Accessories



Capacitors

HVAC - General Accessories

Capacitors

Turbo® 200 MINI Capacitor



Part #	Mfg #	Description	Price
106682	439102	2.5 - 12.5mfd	

Turbo® 200 Capacitor



Part #	Mfg #	Description	Price
106680	439100	Control Volts 370-440	

Turbo® 200X Capacitor



Part #	Mfg #	Description	Price
106681	439101	2.5 - 97.5mfd	



Chemicals

Sealants

Furnace Cement

- *Repairs casting cracks and fills voids*
- *For use on coal or wood burning furnaces and stoves*
- *Ready to use, no mixing*
- *Withstands same temperatures as fire brick*



Part #	Mfg #	Description	Price
005542	45050	16 oz Can	
005543	45105	32 oz Can	

Chemicals

Furnace Cement

- Ready-to-apply, pre-mixed
- High temperature refractory cement for installation and repairing furnaces, heaters stoves and boilers
- Bonds to cast iron, steel, firebrick and glass
- Maximum temperature: 3,000°F



Part #	Mfg #	Size	Color	Price
004418	1354	1 qt	Gray	

Condensate Pumps

VCMA Automatic Condensate Pumps

- Suitable for high-efficiency, gas furnace condensate
- Fully automatic
- 1/2 Gallon leak proof, rustproof, high impact ABS tank
- (3) Drain holes
- Removable 3/8" barbed check valve
- 3-Prong plug
- Snap-action switch
- Stainless steel shaft
- Polypropylene impeller
- ABS Plastic motor, tank cover and volute
- Includes check valve
- Optional safety switch
- Thermal overload protection



VCMA Series Condensate Pump less Tubing

- S Suffix = safety switch
- 6' Cord

Part #	Mfg #	Model	Description	Price
005997	554405	VCMA-15ULS	115V, 15' Shut-Off	
005998	554425	VCMA-20ULS	115V, 20' Shut-Off	

VCMX NEXTGen™ Automatic Condensate Pumps

- Dimensions: 4.8" x 10.2" x 6.5"
- Oil resistant tank and check valve to eliminate problem of cracked tanks
- 1/4-Turn check valve allows servicing without removal of tubing
- Patent-pending cooling design
- Rubber feet absorb vibration
- Thermal overhead protection
- External overflow safety switch
- External test/run lever
- External tank anti-sweat sleeve
- Multiple brackets: steel mounting bracket for use on either side of tank
- 2-Year warranty



VCMX Series Condensate Pump less Tubing

- 20' Shut-off
- 6' Cord

Part #	Mfg #	Model	Description	Price
120046	554530	VCMX-20ULS	115V, Safety Switch	

Electronic Condensate Pumps

- Maximum flow: 4 gph
- Compact 2-piece design allows flexible installation for mini-split A/C units
- Self-priming pump can be located up to 3' above reservoir
- Suction tubing: 3" x 5/32" ID
Vent tubing: 8" x 5/32" ID
Drain tubing: 3" x 1/2" ID



Part #	Mfg #	Model	Description	Price
053838	553455	EC-400	115V 60Hz	
106971	553458	EC-400	230V 60Hz	

Condensate Pumps

HVAC - General Accessories

Condensate Pumps

LCU Series Condensate Pump

- High impact ABS tank
- Wall mounts
- (3) Intake holes
- 3/8" OD Outlet
- Barbed and threaded discharge connection
- Removable check valve
- Stainless steel shaft
- 6' Power cord with ground
- Thermally protected
- Quiet operation
- 3-Year warranty

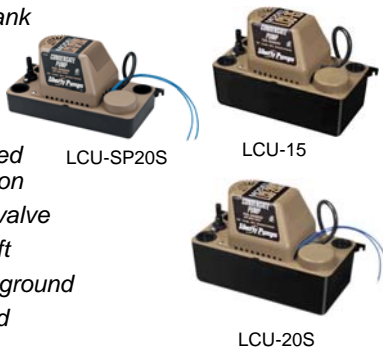

Part #	Mfg #	Description	Price
120642	LCU-15	115V, 1/50 hp	
123251	LCU-20S	115V, 1/30 hp, w/Safety Switch	
124593	LCU-SP20S	115V, 1/30 hp, w/Safety Switch, Shallow Pan Design	

Condensate Pumps

Condensate Pumps

ClearVue™ Pump - No Float, No Problem

- *iQ Technology™ to think and adapt to changing conditions*
- *Variable lift*
- *Self-cleaning*
- *Floatless Sensor™*



Part #	Mfg #	Description	Price
143695	IQP-120	Clearvue™ Pump 120V	

Condensate Pumps

HVAC - General Accessories

Condensate Pumps
Mini-Split Condensate Pump

- Integral Pump-Tank
- Piston pump type
- 120/230V
- 3.25ft Power cord length
- Safety switch included
- 104°F Max water temp



Part #	Mfg #	Power Supply & Consumption	CTN Weight	Price
158107	ASP-MW-UNI	120/230V .11A 16W	1-3/4 lbs	

Condensate Traps

Condensate Traps

- Full-flow condensate traps
- Each trap is carefully sized, minimizing bothersome clogged trap service calls
- Manufactured to demanding standards



Part #	Mfg #	Description	Price
002271	0356	3/4" Sch 40 PVC P-Trap	
116687	0357	3/4" Sch 40 PVC R-Trap	
116848	16349	1" Sch 40 PVC R-Trap	

Condensate Traps

Condensate Traps

Residential Condensate Trap

- 3/4" Sch. 40 PVC trap saves fittings and job costs when trapping coil condensate lines



Part #	Mfg #	Type	Size	Price
027598	867-30	P-Trap	8" x 2-1/2"	

Disconnects/Fuses/Electrical Box Covers

Electrical Boxes

Handy Boxes - Standard Steel Utility Box

- Dimensions: 4"H x 2-1/8"W



Part #	Mfg #	Description	Price
002313	7596	2-1/8" Deep, 1/2" KO's	

Steel Electrical Box

- 1/2" & 3/4" Knockouts



Part #	Mfg #	Description	Price
143518	7588	4" Square x 2-1/8" Deep	

Electrical Receptacles

Premium Duplex Receptacle

- Premium specification grade
- 2-Pole, 3-wire grounding receptacles
- Side-wired



Part #	Mfg #	Description	Price
141783	16573	15A, 125V White	

Electrical Switches

Standard Toggle Switch

- Combination of side wiring & push-in wiring
- Framed toggle
- 15A 1/2 hp 120V



Part #	Mfg #	Description	Price
140155	16571	Grounded, White	

HVAC - General Accessories



Disconnects/Fuses/Electrical Box Covers

Fuses



46-22863-82-5PK



44-ATC3-5PK

Part #	Mfg #	Description	Price
056101	44-ATC3-5PK	Fuse 3A 5-Pack	
064538	46-22863-82-5PK	Fuse 2A 5-Pack	

Disconnects/Fuses/Electrical Box Covers

Fuses

Box Cover Units

- Maximum 15 Amps
- Maximum 125VAC
- UL Listed and CSA certified
- For use with type T plug fuses



Part #	Mfg #	Description	Price
002302	620-608	Switch/Fuse Combo/ESSU	

Disconnects

DiversiTech Pull-Out Disconnect Switch

- Side opening door
- Line, load, and ground terminals aligned
- Reversible door
- Full dead front



Part #	Mfg #	Description	Price
132308	DDS-60U	60A, Non-Fused	

HVAC - General Accessories

Electrical Tape

Tape

Scotch 3M Super 33+ Electrical Tape

- Premium grade, 7 mil all-weather vinyl insulating
- Temperature range: 0° to 220°F



Part #	Mfg #	Size	Price
132145	ET33	3/4" x 66'	

HVAC - General Accessories

Electrical Tape

Tape
Electrical Tape

- Individually wrapped
- Black vinyl
- UL Listed



Part #	Mfg #	Size	Price
106658	T20-030	3/4" x 60'	

Electrical Tape

Amazing! Tile Tape

- Makes watertight junctions and connections for plastic tubing
- Made out of PVC, which provides super stretchability
- Properties:
 - Tensile strength: 20#/sq inch
 - Elongation: 230%
 - Dielectric: 8800V
 - Thickness: 8 mm



Part #	Mfg #	Description	Price
127854	BT02ADC	2" x 108' Roll	

HVAC - General Accessories

Gas Valves

VR Series Combination Gas Controls

- Standard features for combination gas valves include:
 - (2) Automatic valves
 - Solenoid-operated first automatic valve opens on thermostat call for heat; closes when call for heat ends.
 - Diaphragm-operated second automatic valve opens under control of regulator; closes if gas or power supply is interrupted
 - Meets codes requiring dual safety shutoff
 - Mounting: 0° to 90°, any direction from upright position of gas control knob, including vertically

VR8200 Continuous Pilot Dual Automatic Valve Combo Gas Control

- For 24VAC gas-fired, standing pilot appliances with capacities from 20-200 cfh
- Includes all standard features plus:
 - Controls include manual valve, (2) automatic operators, Servco pressure regulator and pilot adjustment
 - Standard and slow opening natural gas models include natural to LP gas conversion kits; LP to natural gas conversion kits are also available
 - All adjustments, wiring connections and pilot outlets are accessible from the top of control
 - LITE-RITE (Off-Pilot-On) lighting sequence
 - Compatible with ECO connector
 - Capacities based on 1" p.d. 20,000 BTUH minimum, 130,000 BTUH maximum



HVAC - General Accessories

Part #	Mfg #	Inlet/Outlet Size	Capacity cfh	Capacity m3/hr	Pressure Regulator Setting	Type of Gas	Type of Pressure Regulator	Price
006813	VR8200A2132	1/2" x 1/2"	130	3.7	3.5"wc/0.9kPa	NG	Std (1)	

(1) Includes 393691 NG to LP conversion kit, 1/2"x 3/8" reducer bushing, 393690-14 bag assembly - 3/4" straight flange with o-ring, screws and wrench

VR8300A Continuous Pilot Dual Automatic Valve Combo Gas Control

- For 24VAC gas-fired, standing pilot appliances with capacities from 30-300 cfh
- Includes all standard features plus:
 - Controls include 100% safety shutoff, manual valve, magnetic operators, pressure regulator and pilot adjustment
 - Standard and slow opening natural gas models include natural to LP gas conversion kits; LP to natural gas conversion kits are also available
 - All adjustments, wiring connections and pilot outlets are accessible from the top of control
 - LITE-RITE (Off-Pilot-On) lighting sequence
 - Compatible with ECO connector
 - Ambient temperature ratings: 0° to 175°F
 - Capacities based on 1" p.d. 30,000 BTUH minimum, 190,000 BTUH maximum



Part #	Mfg #	Inlet/Outlet Size	Capacity cfh	Capacity m3/hr	Pressure Regulator Setting	Type of Gas	Type of Pressure Regulator	Price
006815	VR8300A3500	1/2" x 3/4"	190	5.4	3.5"wc/0.87kPa	NG	Std (1)	

(1) Includes (1) 3/4"x 1/2" reducer bushing, 393691 NG to LP conversion kit

Gas Valves

HVAC - General Accessories

VR8345 Universal Electronic Ignition Combination Gas Control

- For use with direct spark ignition, hot surface ignition or intermittent pilot ignition in 24VAC, gas-fired appliances, with capacities from 30 to 415 cfh
- Includes all standard features plus:
 - Manual valve, two automatic operators, pressure regulator, pilot adjustment, pilot plug and ignition adapter
 - Replaces virtually any IP, HSI or DSI gas control
 - For use with natural or manufactured gas or LP gas
 - Includes converter kit to adapt from natural gas to LP gas
 - 4" Swing radius allows easy rotation into position inside the tightest furnace vestibules
 - Clearly marked, keyed terminal block allows quick attachment wires and IP/DSI/HSI jumper
 - Internal inlet screen blocks contaminants in gas line from entering valve
 - Capacities based on 1" p.d. 30,000 BTUH minimum, 300,000 BTUH maximum



Part #	Mfg #	Inlet/Outlet Size	Capacity cfh	Capacity m3/hr	Pressure Regulator Setting	Type of Gas	Type of Pressure Regulator	Price
025055	VR8345M4302	3/4" x 3/4"	300	8.5	3.5"wc/0.87kPa	NG	Std (1)	

(1) Includes two 3/4" x 1/2" NPT reducer bushings and one 1/2" x 1/2" NPT bushing

Combination Gas Controls

V800 Low Voltage Standing Pilot Gas Control

- Auto 24V control for use with 30mV thermocouple, includes integral A and B gas cock, magnetic operator, pressure regulator, auto pilot, 100% shut-off, pressure tap and filter, one 36" thermocouple and LP kit
- Color coded blue to identify 24V operation



Part #	Mfg #	Inlet/Outlet Size	Capacity cfh	Capacity m3/hr	Pressure Regulator Setting	Type of Gas	Type of Pressure Regulator	Price
006820	V800A1070	1/2" x 3/4"	250	7.1	3.5"wc/0.87kPa	NG	Std (1)(2)(3)	
006821	V800A1088	3/4" x 3/4"	335	9.5	3.5"wc/0.87kPa	NG	Std (1)(2)(3)	

(1) Includes one 3/4" x 1/2" and one 1/2" x 3/8" reducer bushing/adapter

(2) Includes Q340 (36") thermocouple with adapters

(3) NG to LP Conversion Kit

Gas Valves

VS820 Millivoltage Combo

- Provides complete control of continuous pilot gas-fired central furnaces and boilers
- Self-powered automatic control for use with 750mV thermocouple
- Includes pilot flow adjustment screw
- All adjustments and connections are accessible from top of control
- Add separate energy cutoff (ECO) where codes call for dual safety shutoff
- Complete safety shutoff on pilot flame failure
- LITE-RITE (Off-Pilot-On) lighting sequence
- Adjustable pressure regulator
- Temperature range: 32° to 175°F
- Mounting 0° to 90° in any direction from the upright position of the gas control knob, including vertically



HVAC - General Accessories

Part #	Mfg #	Inlet/Outlet Size	Capacity cfh	Capacity m3/hr	Pressure Regulator Setting	Type of Gas	Type of Pressure Regulator	Price
006816	VS820A1047	1/2" x 3/4", 1/2" Side Outlets	250	7.1	3.5"wc/0.87kPa	NG	Std (1)	

(1) Includes one 3/4" x 1/2" and one 1/2" x 3/8" reducer bushing/adaptor

SmartValve® Hot Surface Pilot Ignition Controls

SV9501 SmartValve® System Control

- Provides easy field replacement of a wide range of SV9500, SV9501, SV9502, SV9601 and SV9602 SmartValve® System models
- Gas appliance manufacturers use these models in many types of gas fired heating appliances including central furnaces, residential boilers, rooftop furnaces, commercial cooking appliances and unit heaters
- Provides intermittent pilot gas ignition sequencing, pilot flame sensing, and both pilot and main gas control functions in a single control
- Ignition sequence includes timed trial for ignition
- Compatible with Q3450 or Q3480 intermittent pilot burners used with the original controls on the appliance



Part #	Mfg #	Description	Price
098756	SV9501M2528	Intermittent HSI Pilot , 1/2" x 1/2" In/Out, 3.5"wc Standard Opening, Natural Gas	

Gas Valves

HVAC - General Accessories

SV9641 SmartValve® System Control

- Combines gas flow control and electronic intermittent pilot sequencing functions
- Q3450 or Q3480 Pilot hardware supplies the low voltage igniter, flame sensor and pilot burner
- Communicates directly with an electronic fan timer (ST9160 for single-stage applications; ST9162 for 2-stage applications) in typical forced warm air furnace applications
- Provides pre purge, post purge, timed trial for pilot ignition, with 100% shutoff and continuous retry
- Suitable for wide range of fan assisted combustion gas-fired appliances including: furnaces, rooftop furnaces, boilers, unit heaters, infrared heaters, water heaters, and commercial cooking appliances
- Ambient temperature range: -40° to 175°F
- Diagnostic LED



Part #	Mfg #	Description	Price
144233	SV9641M4510	2-Rod Flame Sense, 3/4" NPT x 3/4" NPT Intermittent Hot Surface Pilot Ignition SmartValve®	

Gas Valves

Gas Valves

700 24 Volt Combination Valve

- Electrical rating: 0.18A @ 12VDC
0.2A @ 24VAC



Part #	Mfg #	Inlet Size	Outlet Size	Straight Through	Side Outlet w/Plugs	Pressure Regulator Setting	Capacity	Price
058059	700-400	1/2" FPT	3/4" FPT	Yes	None	Uni-Kit	240,000	

**720 Series Dual Valve Gas Control
24V Hot Surface - Intermittent Pilot Ignition**



Part #	Mfg #	Inlet Size	Outlet Size	Straight Through	Side Outlet w/Plugs	Pressure Regulator Setting	Capacity	Price
042430	720-400	1/2" FPT	3/4" FPT	Yes	None	Uni-Kit	150,000	

24V Standing Pilot - Step-Opening w/Convertible Pressure Regulator

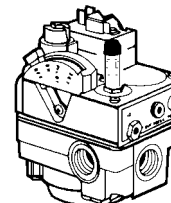

Part #	Mfg #	Inlet Size	Outlet Size	Straight Through	Side Outlet w/Plugs	Pressure Regulator Setting	Capacity	Price
044307	720-474	1/2" FPT	1/2" FPT	Yes	1/2" FPT	Yes	150,000	

HVAC - General Accessories

Gas Valves

HVAC - General Accessories

720 Series Gas Valve Uni-Kits®

- *Designed for intermittent pilot ignition applications*
- *24V*
- *Direct spark, electronic ignition*
- *Valve features:*
 - *Manual valve*
 - *Pilot valve*
 - *(2) Dual automatic valves*
 - *Main gas pressure regulator*



Part #	Mfg #	Inlet Size	Outlet Size	Straight Through	Side Outlet w/Plugs	Pressure Regulator Setting	Capacity	Price
044306	720-079	1/2" FPT	3/4" FPT	Yes	1/2" FPT	Uni-Kit	150,000	

Heat Shrink Tubing

**Heat Shrink
Heat Shrink Tubing**



Part #	Mfg #	Description	Price
140501	455062	Assortment: (5) 1/4", (4) 3/16", & (3) 3/8"	
140612	455153	Rainbow Assortment: (5) 1/4", (4) 3/16", & (3) 3/8"	

HVAC - General Accessories

Igniters

Igniters

Glowfly™ Universal Hot Surface Igniter

- Uses a 120V silicon nitride igniter design with long life and high resistance to damage or burn out in the appliance
- Kit includes specially designed silicon nitride igniter and six different bracket configurations
- Clear instructions and application templates are provided
- Replaces over 110 different models
- 3-Year warranty



Part #	Mfg #	Description	Price
126476	Q3200U1004	Glowfly™ Universal Hot Surface Igniter Kit	

Q4100 Silicon Carbide Hot Surface Igniter

- Q4100 igniters work with most configurations of element shapes, brackets, connectors, and lead wire lengths
- Honeywell igniters are made in the USA and backed by a 2-year warranty
- Temperature rating: 392 °F
- 120 Volt
- Natural LP gas



Part #	Mfg #	Description	Price
181450	Q4100C9040/U	120 Volt, Silicon Carbide Hot Surface Igniter with 5-1/4 in. lead lengths	
181451	Q4100C9042/U	120 Volt, Silicon Carbide Hot Surface Igniter with 5-1/2 in. lead lengths	
181452	Q4100C9044/U	120 Volt, Silicon Carbide Hot Surface Igniter with 6 in. lead lengths	
181453	Q4100C9046/U	120 Volt, Silicon Carbide Hot Surface Igniter with 19-1/8 in. lead lengths	
181454	Q4100C9048/U	120 Volt, Silicon Carbide Hot Surface Igniter with 5-1/4 in. lead lengths	
181455	Q4100C9050/U	120 Volt, Silicon Carbide Hot Surface Igniter with 11 in. lead lengths	
181456	Q4100C9052/U	120 Volt, Silicon Carbide Hot Surface Igniter with 5 in. lead lengths	
181457	Q4100C9054/U	120 Volt, Silicon Carbide Hot Surface Igniter with 5-1/4 in. lead lengths	
181459	Q4100C9056/U	120 Volt, Silicon Carbide Hot Surface Igniter with 5-1/4 in. lead lengths	
181460	Q4100C9058/U	120 Volt, Silicon Carbide Hot Surface Igniter with 4-1/2 in. lead lengths	
181461	Q4100C9060/U	120 Volt, Silicon Carbide Hot Surface Igniter with 5-1/4 in. lead lengths	
181462	Q4100C9062/U	120 Volt, Silicon Carbide Hot Surface Igniter with 5-1/4 in. lead lengths	
181463	Q4100C9066/U	120 Volt, Silicon Carbide Hot Surface Igniter with 5-1/4 in. lead lengths	
181464	Q4100C9068/U	120 Volt, Silicon Carbide Hot Surface Igniter with 5-1/4 in. lead lengths	
181465	Q4100C9070/U	120 Volt, Silicon Carbide Hot Surface Igniter with 5-11/16 in. lead lengths	
181466	Q4100C9072/U	120 Volt, Silicon Carbide Hot Surface Igniter with 5-5/16 in. lead lengths	

Igniter Flame Rod Assembly

- Use with SV9500, SV9600
- Field replacement for Q3450/Q3480 hot surface pilot burner



Part #	Mfg #	Description	Price
097708	Q3400A1024	30" Lead Length	

Igniters

Igniters

41 Series Silicon Carbide Hot Surface Igniters

- Delivers dependable ignition in heating systems of every description
- Engineered for easy handling, simple installation & trouble free operation

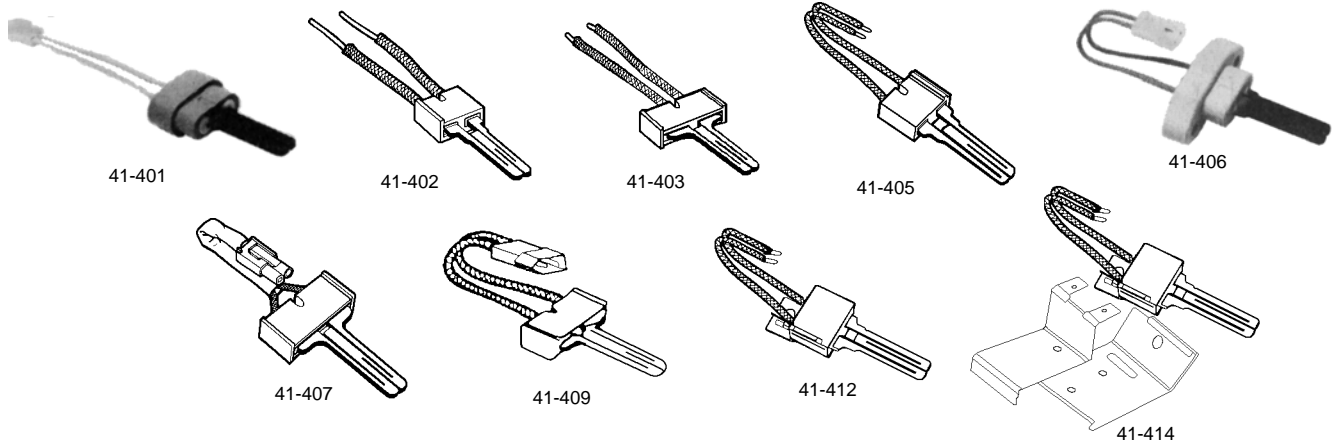

HVAC - General Accessories

Part #	Mfg #	Factory Model#	Ceramic Block Style	Terminal Conn Type	Lead Wire Length	Price
044297	41-401	271A	A	A	4-1/2"	
044298	41-402	217W	B	None	19"	
044299	41-403	271	C	None	5-1/2"	
044300	41-405	2711D	D	None	5-1/2"	
044301	41-406	271Y	E	None	10-1/2"	
044302	41-407	271	C	B	4-1/2"	
044303	41-409	271	C	D	4-1/2"	
044305	41-412	271NM	F	None	5-1/4"	
045277	41-414	271NM	F	None	5-1/4"	

Series 41-600



Part #	Mfg #	Factory Model	Housing Length	Comments	Price
058084	41-605	601XBM +Harness & Brackets	2.5"	York Replacement Conversion Kit #473-20937-001	

Limit Controls

Fan & Limit Controls

L4064B Combination Fan & Limit Furnace Control

- For control of high limit and fan motor in forced air heating systems
- (3) Wiring terminal options:
 - Female receptacles for 1/4" male flange connectors
 - Push-in receptacles for stripped wire
 - Field add-on screw terminals
- Helical bimetal sensing element, high limit set @ 200°F
- Manual fan switch
- Includes jumper



HVAC - General Accessories

Part #	Mfg #	Description	Price
006734	L4064B2210	11-1/2" Insertion, Surface-Mount	
006735	L4064B2228	5" Insertion, Surface-Mount	
006736	L4064B2236	8" Insertion, Surface-Mount	

Oil Furnace Controls

Oil Primary Controls

R8184G Protectorelay® Oil Burner Control

- Provides automatic, non-recycling control of an intermittent ignition oil burner system
- Low volt terminals, line volt lead wire connections and screw
- Intermittent ignition, safety switch
- 120V 60-Cycle or 110V 50-cycle
- Mount on 4" x 4" junction box or direct mount on burner housing
- With LED for lockout indication and manual trip lever on safety switch to assure burner shutdown during servicing
- C554 Cadmium Sulfide Flame Detector and 24VAC thermostat required



Part #	Mfg #	Description	Price
006771	R8184G4009	45-Second Safety Switch	

R8184M Protectorelay® Oil Burner Control

- Operates the oil burner and oil valve (if desired) in response to call for heat from a low voltage control circuit
- Burner mount, low volt terminals, line volt lead wire connections
- Intermittent ignition, 45-second safety switch
- 120V 60-Cycle, intermittent ignition
- 40VA Transformer for heat/cool, 0.2A thermostat current
- Use with C554



Part #	Mfg #	Description	Price
006773	R8184M1051	45 Second Safety Switch, 0.2A Anticipator Setting, Use with C554	

R7284B Electric Oil Primary Control

- Microprocessor oil control
- Mount onto junction box on main burner
- UL and cUL component recognized
- Burner motor, oil valve, ignition, cad cell, limit, thermostat, alarm
- Interrupted ignition type
- LED display
- 15 Second lock out



Part #	Mfg #	Description	Price
189629	R7284B1024/U	15 Second Safety Switch, -40° F to +147° F	

RA116/RA117 Protectorelay® Oil Burner Control

- 1-Piece, stack-mounted oil burner primary controls cycle burner on and shut down burner on flame loss or system malfunction
- 2- or 3-Wire, includes manual trip safety switch lever
- Use with line voltage or 24VAC control circuit
- RA116 - Safety switch heater energizes on flame or power failure lockout occurs if flame is not reestablished by end of safety switch timing



Part #	Mfg #	Description	Price
006764	RA116A1055	360VA, Intermittent Ignition Protectorelay	

HVAC - General Accessories

Oil Furnace Accessories

Flame Sensors

C554 Cadmium Sulfide Flame Detector

- Photo conductive flame sensing device for sequencing oil burner systems



Part #	Mfg #	Description	Price
006719	C554A1463	60" Lead, A/B/E/J/P Type & Oil Line Mounting Bracket Included	

HVAC - General Accessories

Oil Furnace Accessories

Oil Burner Nozzles - Type A Red Vial

- Hollow cone
- Creates stable flame at low flows

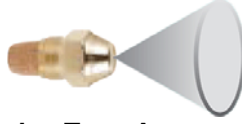

60° Angle Oil Burner Nozzle - Type A

Part #	Mfg #	GPH	Price
007771	0007560A	.75	

70° Angle Oil Burner Nozzle - Type A

Part #	Mfg #	GPH	Price
007778	0008570A	.85	
007759	0010070A	1.00	

80° Angle Oil Burner Nozzle - Type A

Part #	Mfg #	GPH	Price
007779	0008580A	.85	
007761	0010080A	1.00	
007746	0011080A	1.10	
007751	0012580A	1.25	
007756	0015080A	1.50	

Oil Burner Nozzles - Type B Blue Vial

- Solid cone
- For larger burners & where air pattern is heavy in the center or for long fires

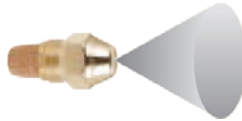

80° Angle Oil Burner Nozzle - Type B

Part #	Mfg #	GPH	Price
007780	0008580B	.85	

Oil Burner Nozzles - Type W Green Vial

- Neither truly hollow nor solid
- Can be used in place of Type A or B Types in reducing specific problems

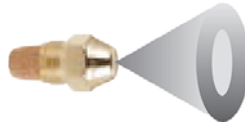

80° Angle Oil Burner Nozzle - Type W

Part #	Mfg #	GPH	Price
007770	0006580W	.65	
007781	0008580W	.85	
007747	0011080W	1.10	

Oil Furnace Accessories

Fuel Filters

Replacement Filter Cartridge

- 10 Micron wool felt
- Center core bonded to prevent media migration



Part #	Mfg #	Description	Price
004856	1A-30	Wool Felt - for Filter 1A-25A	

Pilot Assemblies

Pilot Burners

Q314 Pilot Burner

- Non-primary aerated, insert orifice-type, for main burner ignition with Q340 or Q390 thermocouple for Pilotstat safety control operation
- Use with Q313 Thermopile generator for 750mV power pile applications
- Includes natural gas and LP orifice
- Compression fitting size: 1/4"
- Special mounting bracket with screws for converting "B" bracket to "A"



Part #	Mfg #	Description	Price
006748	Q314A4586	B Bracket, BCR-18/BCR-10 Orifice, Single (F) Front Tip	
037901	Q314A6094	B Bracket, BCR-18 Orifice, Single (L) Left Front Tip	
037902	Q314A6102	B Bracket, BCR-18 Orifice, Single (K) Right Front Tip	

Pressure Regulators

HVAC - General Accessories

Gas Appliance Pressure Regulators

- Gasses: natural, manufactured, mixed, liquefied, petroleum and LP gas-air mixtures
- Corrosion-resistant construction

325-3 Lever Acting Pressure Regulator

- Self-aligning valve with lever action for dead end lockup
- Maximum individual load: 100,000 BTUH
- Capacity: 150,000 BTUH
- Vent pipe connection: 1/8" NPT
- Multi-poise mounting



Part #	Mfg #	Description	Price
124028	325-3L12	1/2" Line Reg with 12A09 Installed	

325-5A Lever Acting Pressure Regulator

- Self-aligning valve with lever action for dead end lockup
- Maximum individual load: 250,000 BTUH
- Capacity: 300,000 BTUH
- Vent pipe connection: 3/8" NPT
- Multi-poise mounting



Part #	Mfg #	Description	Price
138743	325-5L48	1/2" Line Reg with 12A39 & OPD 48 Installed	
113435	325-5L48	3/4" Line Reg with 12A39 & OPD 48 Installed	
078926	325-5L600	3/4" Line Reg with 12A39 & OPD 600 Installed	
118426	325-5L34	3/4" Line Reg with 12A39 Installed	
124030	325-5L1	1" Line Reg with 12A39 Installed	
138744	325-5L600	1" Line Reg with 12A39 & OPD 600 Installed	

325-5L Lever Acting Pressure Regulator

- High leverage linkage assembly to deliver positive dead-end lockup
- Maximum individual load: 425,000 BTUH
- Capacity: 600,000 BTUH
- Multi-positional mounting



Part #	Mfg #	Description	Price
214294	325-5L12	1/2" w/ Vent Limiter 425 CFH w/v Limiter	

Gas Appliance Pressure Regulators (Continued)

325-5L Lever Acting Pressure Regulator

Part #	Mfg #	Description	Price
214291	325-5L34	3/4" w/ Vent Limiter 425 CFH w/v Limiter	
214580	325-5L1	1" w/ Vent Limiter 425 CFH w/v Limiter	

325-7 Lever Acting Pressure Regulator

- Self-aligning valve with lever action for dead end lockup
- Maximum individual load: 1,250,000 BTUH
- Capacity: 1,250,000 BTUH
- Vent pipe connection: 1/2" NPT
- Multi-poise mounting



Part #	Mfg #	Description	Price
086239	325-7AL	1-1/4" Line Press Rated Reg with 12A49 Installed	
075957	325-7AL 1-1/2	1-1/2" Line Press Reg Cert. to 2PSI Ansi Z21.80	

Gas Appliance Pressure Regulators Accessories

Vent Limiting Means

- Automatic vent limiting device
- When using, regulator must be mounted in horizontal upright position
- 12A04 - IAS Certified for 14" wc and European approval, use on RV48, RV52, RV53, RV61



Part #	Mfg #	Description	Price
134390	12A49	For use with 325-7AL	
150323	12A09	For use with 325-3 and 325-3L	

Vent Protector

- Designed for outdoor applications
- Protect breather hole from outside elements
- Must be mounted in upright position
- 13A15 - Use in 325-3, 325-3L
- 13A15-5 - Use in 325-5A, 325-5AL



Part #	Mfg #	Description	Price
071088	13A15	For 1/8" NPT Vent	
152096	13A155	For 3/8" NPT Vent	

Pressure Regulators

**Gas Appliance Pressure Regulators
Accessories (Continued)**

Vent Protector

Part #	Mfg #	Description	Price
145637	13A25	For 1/2" NPT Vent	

Maxitrol® Maxicap

- Rain and bug shield for regulators
- Rubber



Part #	Mfg #	Description	Price
041419	MAXICAP-3R	For 325-3 and 3R Series	
098862	MAXICAP-5R	For 325-3	

Relays

Relays

General Purpose Relay

- Provides general purpose switching for refrigeration and air conditioning equipment, appliances, vending machines, etc
- 50/60Hz

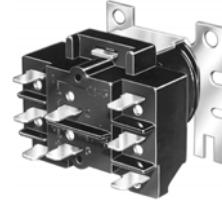

Part #	Mfg #	Description	Price
006769	R4222D1013	DPDT 120V General Purpose, 1 - 6 Power Poles	
006774	R8222B1067	SPDT 24V General Purpose, Double Quick Connect, 1 - 3 Power Poles	
006775	R8222D1014	DPDT 24V General Purpose, Double Quick Connect, 1 - 6 Power Poles	

Hydronic Switching Relays

R8845 Universal Hydronic Switching Relay

- Enclosed switching relay with internal 24V transformer
- (2) SPST, Plus PowerPile® rated low voltage SPST relay (if normally closed contacts are needed, use RA889A)
- Replaces Honeywell models: R182A,B,C,J; R482A,B,C,J; R845; R882A,B,C,J and RA832



Part #	Mfg #	Description	Price
135224	R8845U1003	Intermediate Switching of Line and Low Voltage Devices from a Line or Low Voltage Controller	

Hydronic Switching Relay

- Provides intermediate switching of line voltage device from low voltage controller
- Integral transformer provides low voltage power for control circuit
- Provides DPST switching for hot water zone control systems, or SPST control of two separate loads
- Color-coded lead wire for easier wiring
- 50/60Hz

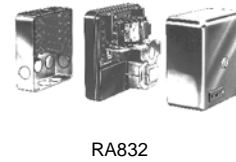

Part #	Mfg #	Description	Price
006767	RA89A1074	SPST 120V Enclosed 2-Wire for 1-Line Voltage Load	
006766	RA832A1066	DPST 120V Enclosed 2-Wire for 2-Line Voltage Loads	
030533	RA832A1074	DPST 240V Enclosed 2-Wire for 2-Line Voltage Loads	
033261	R845A1030	DPST 120V for Hot Water Zone Control Systems, 2-Wire for 2-Line Voltage Loads	

HVAC - General Accessories

Smoke Bombs

Smoke Testers

Smoke Bomb

- *Emits dense oil-free non-toxic smoke*
- *Easily locates leaks in furnaces and ductwork*
- *Non-explosive, packaged in sealed capsules*

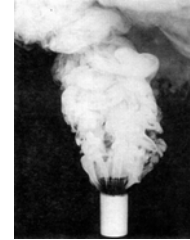

Part #	Mfg #	Description	Price
135426	0118	1,060 Cu/Ft, 2-1/2 Min Burn	
135427	0119	2,500 Cu/Ft, 4 Min Burn	

HVAC - General Accessories

Spades & Other Electrical Connectors

HVAC - General Accessories

Motor Accessories

Wiring Harness

- Use with Copeland Compressor with Molded Plug Connections



Part #	Mfg #	Description	Price
105788	45-100834-80	Bulk Pack (25/Case)	

Terminals & Connectors

Ring Flag Terminal

- 50/Pk



Part #	Mfg #	AWG	Connector Type	Size	Price
140452	455011	16-14	Ring Terminal	#10 Stud	

Quick Connect Flag Terminal

- 50/Pk



Part #	Mfg #	AWG	Connector Type	Size	Price
140454	455014	16-14	Quick Connect	1/4" FIP	

Quick Connect Compressor Terminal

- 50/Pk



Part #	Mfg #	AWG	Connector Type	Size	Price
140455	455015	12-8	Compressor Terminal	1/4" FIP	

Quick Connect to Stud Adapter

- 50/Pk
- Uninsulated



Part #	Mfg #	Tab Size	Terminal Size	Price
140458	455018	1/4"	#10 Stud	

Quick Connect Spade Adapter

- Female to double male (Flat Style)
- 50/Pk
- Uninsulated



Part #	Mfg #	Tab Size	Tab Type	Price
140459	455019	1/4"	Female	

Quick Connect Adapter

- .296 Chair Gold Double Male/Single Female Adapter
- 50/Pk

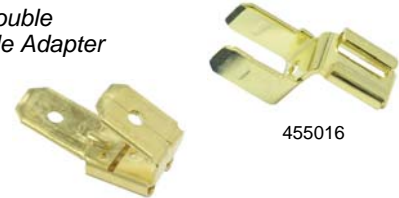

455017

455016

Part #	Mfg #	Description	Price
140456	455016	Chair Style	
140457	455017	Piggyback Style	

Insulated Quick Connect



455045

Part #	Mfg #	AWG	Color	Tab Size	Pk	Price
140482	455043	22-18	Red	1/4"	50	
140483	455045	16-14	Blue	1/4"	100	
140484	455046	16-14	Blue	1/4"	50	
140485	455047	16-14	Blue	1/4"	100	
140486	455048	16-14	Blue	1/4"	50	
140488	455049	12-10	Yellow	1/4"	100	
140489	455050	12-10	Yellow	1/4"	50	
140564	455091	16-14	Blue	3/16"	15	
140565	455092	16-14	Blue	1/4"	15	
140566	455093	12-10	Yellow	1/4"	15	
140611	455152	22-18	Red	1/4"	50	
140562	455089	12-10	N/A	1/4"	25	

With Piggyback



Part #	Mfg #	AWG	Color	Tab Size	Pk	Price
140492	455052	16-14	Blue	1/4"	50	

Spades & Other Electrical Connectors

Fully Insulated Quick Connect



455145

Part #	Mfg #	AWG	Color	Tab Size	Pk	Price
140493	455053	16-14	Blue	1/4"	100	
140603	455144	12-10	Yellow	1/4"	50	
140604	455145	16-14	Blue	1/4"	100	
140628	455170	16-14	Blue	1/4"	20	

Twist-On Plastic Wire Connector



455163

Part #	Mfg #	AWG	Color	Pk	Price
140622	455163	22-14	Blue	1000	
140517	PD455075	22-14	Blue	50	
140567	455094	22-14	Blue	15	
140631	455173	22-14	Orange	50	
140627	455169	18-12	Yellow	100	

Closed Connector



Part #	Mfg #	AWG	Color	Pk	Price
140460	455020	22-14	Clear	50	
140461	455021	12-10	Clear	25	

Uninsulated Butt Connectors



Part #	Mfg #	AWG	Color	Pk	Price
140608	455149	16-14	SS	50	

Insulated Butt Connectors



455039

Part #	Mfg #	AWG	Color	Pk	Price
140478	455038	22-18	Red	100	
140479	455039	16-14	Blue	100	
140480	455040	16-14	Blue	50	
140481	455042	12-10	Yellow	50	
140518	455076	22-18	Red	15	
140520	455078	16-14	Blue	15	
140563	455090	12-10	Yellow	15	
140630	455172	12-10	Yellow	100	

Ring Terminal



455080

Part #	Mfg #	AWG	Size	Pk	Price
140451	455010	8	1/4" Stud	25	
140521	455080	16-14	#10 Stud	50	

Insulated Ring Terminal



455024

Part #	Mfg #	AWG	Color	Size	Pk	Price
140463	455024	16-14	Blue	#6	100	
140464	455025	16-14	Blue	#6	50	
140465	455026	16-14	Blue	#10	100	
140466	455027	16-14	Blue	#10	50	
140469	455030	12-10	Yellow	#10	100	
140470	455031	12-10	Yellow	#10	50	
140471	455032	12-10	Yellow	5/16"	50	
140472	455033	8	Red	#10	50	
140605	455146	8	Red	1/4"	50	
140606	455147	8	Red	1/4"	25	
140607	455148	12-10	Yellow	1/4"	100	
140613	455154	16-14	Blue	#8	19	
140614	455155	16-14	Blue	1/4"	100	

HVAC - General Accessories

Spades & Other Electrical Connectors

HVAC - General Accessories

Insulated Spade Terminal



455074

Part #	Mfg #	AWG	Color	Size	Pk	Price
140516	455074	16-14	Blue	#8	50	
140474	455034	16-14	Blue	#8	15	
140475	455035	16-14	Blue	#10	100	
140476	455036	12-10	Yellow	#8	25	
140477	PD455037	12-10	Yellow	#10	25	

Compressor Lead Set



Part #	Mfg #	AWG	Ring Size	Butt Size	Price
140498	455059	10	#10	10"	

Strip-Tie



Part #	Mfg #	Length	Width	Max Dia	Pk	Price
140467	455028	12"	3/4"	3"	Black	
140468	455029	12"	3/4"	3"	Yellow	

Motor Hook-Up Wire



Part #	Mfg #	AWG	Length	Color	Price
140522	455081	10	8'	Black	
140600	455141	10	8'	Blue	
179378	PD455082	10	8'	Red	
140601	455142	10	8'	White	
140556	455083	12	12'	Black	
140597	455138	12	12'	Blue	
140557	455084	12	12'	Red	

Terminals & Connectors (Continued)

Motor Hook-Up Wire

Part #	Mfg #	AWG	Length	Color	Price
140598	455139	12	12'	White	
140558	455085	14	15'	Black	
140595	455136	14	15'	Blue	
140599	455140	14	15'	Green	
140559	455086	14	15'	Red	
140596	455137	14	15'	White	
140560	455087	16	16'	Black	
140561	455088	16	16'	Red	
140594	455135	16	16'	White	

Metal Box for Electrical Connectors

- 14"x9-1/4"x2"



Part #	Mfg #	Description	Price
140616	455157	21 Compartment	

Spades & Other Electrical Connectors

Terminal Kits

Serviceman's Terminal Kit

- Consists of 175 assorted insulated and non-insulated items that are often used to service air conditioning, refrigeration and cooling units



Part #	Mfg #	Description	Price
111395	MA02652-2	Heavy-Duty Molded Plastic Case	



Spades & Other Electrical Connectors

Terminals & Connectors Connector Kit

Part #	Mfg #	Description	Price
140444	86-6966F-1PK	665-Piece Professional HVAC Connector Kit	

Terminal

Part #	Mfg #	Description	Price
092116	86-QT2910	Qwiklug Terminal Repair Kit	

HVAC - General Accessories

Temporary Construction Thermostats

Thermostats

Temporary Construction Thermostat

- *Low cost*
- *Mercury-free and non-adjustable*
- *Rugged construction is not effected by heat, moisture, paint and drywall dust*



Part #	Mfg #	Description	Price
034003	20064	TS-60, 60°F, Heat Only	
034004	20065	TS-65, 65°F, Heat Only	
034005	20066	TS-70, 70°F, Heat Only	

HVAC - General Accessories

Temporary Construction Thermostats

T812 Low Voltage Control Thermostats

- Snap-acting, bi-metal switch less mercury and requires no leveling
- For low voltage control of single-stage heating, cooling or heating/cooling systems
- Includes dealer logo pocket
- Switch type: snap-acting
- Electrical ratings: 18 to 30VAC
- Setting temperature change: 50° to 90°F
- Dimensions: 3-1/8"H x 3-1/8"W x 7/8"D
- Mounting: square



HVAC - General Accessories

Part #	Mfg #	Application	Switching Action	Terminal Designations	Color	Price
101204	T812A1002	Heat Only	SPST	W,R	White	

Thermocouples

Power Generators

Q313 Replacement Thermopile Generator

- Provides power for a millivoltage, self-powered control system
- Includes spade terminals
- Use with Q314, Q324, Q327, Q377, Q379 and Q382 pilot burners



Part #	Mfg #	Description	Price
006746	Q313A1139	600-750mV Replacement Thermopile Generator, 35" Lead, Push-in Clip	
006747	Q313A1170	600-750mV Replacement Thermopile Generator, 35" Lead, PG9 Adapter	

Thermocouples

Q340 Universal 30 mV Thermocouple

- Includes push-in clip, split nut and adapter assembly for easy pilot burner installation
- Male nut connector for Pilotstat™ safety control power units



Part #	Mfg #	Description	Connection	Price
006750	Q340A1066	18" Lead	11/32"-32 Male Connector Nut	
006751	Q340A1074	24" Lead	11/32"-32 Male Connector Nut	
006752	Q340A1082	30" Lead	11/32"-32 Male Connector Nut	
006753	Q340A1090	36" Lead	11/32"-32 Male Connector Nut	
006754	Q340A1108	48" Lead	11/32"-32 Male Connector Nut	

HVAC - General Accessories

Thermocouples

Thermocouples & Pilots

1951 Thermopile

- *Designed for use on self-powered gas control systems*
- *Easy burner installation with attached threaded nut*
- *Stainless steel outer jacket for long life and resistance to heat blistering*
- *Combination of copper and nickel alloys for good electrical conductivity*
- *Mica washer to insulate from shorting conditions*
- *Various lengths available for multiple applications*

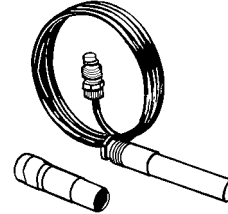

Part #	Mfg #	Length	Includes PG 9Pilot Adapter	Connection Type	Price
044312	1951-536	36"	Yes	Coaxial	

1980 Snap-Fit™ Thermocouple

- *Offers easy installation into the majority of pilot burners*

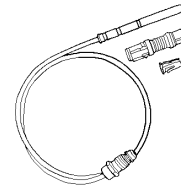

Part #	Mfg #	Length	Price
044326	1980-018	18"	
044329	1980-036	36"	

HVAC - General Accessories

Thermocouples

Thermocouples

K16 Series - "Husky™" High Performance Thermocouple

- Heavy-duty
- Millivolt range: 25 - 35 mV
- Replaces BASO 17D, 50, 58D, 87D, 88D, 97D, 107D, & K15DA thermocouples



Part #	Mfg #	Length	Carton Quantity	Price
074880	K16FA-36	36"	10	

HVAC - General Accessories



ecobee Thermostats

Thermostats

Wireless Smart Thermostat

- Internet enabled
- "Quick save" automatically sets your system to conserve energy and save you money
- Manage your home from anywhere



Part #	Mfg #	Description	Price
135356	EB-STAT-02	1 Heat/1 Cool	

Thermostats

T87K, T87N Non-Programmable Thermostats - The Round®

- Mercury free
- Provides electronic control of 24VAC heating and cooling systems
- Separate temperature setting and thermometer
- Classic twist dial
- Manual changeover
- Battery assisted power stealing
- Setting temperature range: 40° to 90°F
- Premier White®



T87K1007



T87N1000



T87N1026

Part #	Mfg #	Application	Terminal Designations	Dimensions	Price
099889	T87K1007	Heat Only	R,W,Y	3-11/16" Dia x 1-3/4"D	
096104	T87N1000	1 Heat/1 Cool Conv & Heat Pump	R,Rc,W,Y,G,O,B	3-11/16" Dia x 1-3/4"D	
099891	T87N1026	1 Heat/1 Cool Conv & Heat Pump*	R,Rc,W,Y,G,O,B	4" Dia x 1-3/4"D	

* EASY-TO-SEE Model with large raised markings & click at each 2° set point change, includes 6" cover ring & switch position labels

T822K, T827K Econostat Heat Only Non-Programmable Thermostats

- Mercury free
- 24VAC Control of single stage low voltage heating systems
- Vented cover for improved temperature sensing
- Coiled bi-metal element operates mercury switch
- Mounts vertically directly on the wall or on vertical outlet box
- Precision snap action switch
- Dimensions: 4-3/4"H x 2-7/8"W x 1-3/8"D
- Premier White®



Part #	Mfg #	Application	Switching Action	Setting Temp Range	Terminal Designations	Description	Price
124832	T822K1042	1 Heat	SPST	35° - 85°F	R,W	Heat-Off	

HVAC - General Accessories

Thermostats

HVAC - General Accessories

T8775 The Digital Round™ Electronic Non-Programmable Thermostats

- Attractive styling complements any decor
- Large easy-to-read display - the temperature reading is easily seen from a distance
- Backlit display
- No batteries required - the set point temperature is held permanently in memory in the event of a power failure.
- Powered through heating-cooling system controls
- 24VAC Gas or oil
- System and fan switches on the T8775C model
- Manual changeover from heat to cool on T8775C model
- Easy installation and set up
- Easily configurable by the use of DIP switches
- Fahrenheit or Celsius temperature
- Selectable heating cycle rates (1, 3, 6, 9 CPH) for a variety of applications
- Cooling cycle rate is fixed at 3 CPH (standard compressor setting)
- Minimum off-time for the compressor in the cooling mode. Protects and extends the life of the equipment
- Decorative cover plate is available to cover marks on the wall or to mount the T8775 Thermostat to an electrical box
- Premier White®



T8775A



T8775C

Part #	Mfg #	Application	Terminal Designations	Notes:	Price
099892	T8775A1009	1-Stage Heat Only, Gas or Oil; 2-Wire	R,Rc,W,Y,G,O,B		
074622	T8775C1005	1 Heat/1 Cool Heat Pump, No Aux Heat	R,Rc,W,Y,G,O,B	Manual Changeover	

Lyric Wi-Fi Thermostat

- Remote Access
- Lyric App allows you to control with your smart phone or tablet
- Geofence control for savings when you're away and comfort when you're home
- Fine Tune temperature control
- Smart Cues for system information and recommendations
- Programmable with Geofencing
- Hardwired, battery back-up, power transformation



Part #	Mfg #	Description	Price
223085	TH8732WFH5002	3 Heat/2 Cool Heat Pumps; Up to 2 Heat/2 Cool Conventional Systems	

Thermostats

VisionPRO® 8000 Universal Touchscreen 7-Day Programmable Thermostats

- Electronic control of 24VAC, heating and cooling systems or 750mV heating systems
- Universal system compatibility, heating only or heating and cooling; conventional or heat pump systems
- Large back light on-screen menu
- Ability to select multiple days
- Real-time clock
- Armchair programming - allows you to remove thermostat from wall to set the schedule
- Multiple HOLD, lockout options
- Adaptive Intelligent Recovery™
- Programmable fan
- Auto or manual changeover
- Dual-powered, battery or hardwired
- Change reminders - reminds you to service or replace the air filter, humidifier pad, ultraviolet lamp or thermostat batteries
- Temperature range:
 - Heat: 40° to 90°F
 - Cool: 50° to 99°F
- Horizontal mounting, dimensions: 4-9/16"H x 6"W x 1-1/4"D
- Premier White®
- 5-Year warranty



HVAC - General Accessories

Part #	Mfg #	Application	Terminal Designations	Notes:	Price
155766	TH8321R1001	3H/2C Heat Pump, 2H/2C Conv	R,RC,W,(O/B),W2(AUX),Y,Y2,L*,E,G,C,S1,S2	Dehumidity Control	
155765	TH8320R1003	3H/2C Heat Pump, 2H/2C Conv	R,RC,C,W-O/B,W2-AUX/E,Y,Y2,G,A-L/A,K,S1		
181757	TH8321WF1001	3H/2C Heat Pump, 2H/2C Conv	R,RC,W,(O/B),W2(AUX),Y,Y2,L*,E,G,C,S1,S2		

* The L terminal is an input or output

Thermostats

HVAC - General Accessories

VisionPRO® 8000 with RedLINK™ Technology

- Thermostat works standalone or with the THM5421R1021 Equipment Interface Module or with the TrueZONE Wireless Adapter
- Smart Schedule - programs in seconds for any lifestyle
- Patented interview based programming and installer setup
- RedLINK™ wireless communication
- Customizable service reminders allow dealers to remind their customers when its time to call for service, when their warranty is expiring and to provide customized alerts.
- MicroSD port for copying the installer setup, customizable reminders, custom events and holidays to multiple thermostats.
- 1 assignable output on the TH8321 model to control humidification, dehumidification, ventilation or a stage of heating/cooling.
- 3 assignable outputs on the Equipment Interface Module to control humidification, dehumidification, ventilation or a stage of heating/cooling
The TH8110 and TH8320 models require the use of a wireless indoor sensor to control humidification and dehumidification
- 1 assignable input can be used with a wired outdoor, indoor or discharge sensor
- 4 assignable inputs on the Equipment Interface Module can be used with wired outdoor, indoor or discharge sensors, occupancy sensor for remote setback and dry contact devices to trip pre-packaged or custom alerts such as a full drain pan or water leak
- Extend wireless range of the Equipment Interface Module by connecting a THM4000R1000 Wireless Adapter to the ABCD terminals
- Dual powered - battery or hardwired (C wire)
- Precise temperature control (+/- 1° F) for reliable and consistent temperature
- Multiple staging options to provide comfort or energy savings



Part #	Mfg #	Application	Terminal Designations	Notes:	Price
155764	TH8110R1008	1H/1C Conv and Heat Pump	R, RC, C, W-O/B, Y, G, K, S1 S1		

VisionPRO® 8000 with RedLINK™ Technology - Kit

- Includes:
 - RedLINK™ Internet Gateway
 - Portable Comfort Control
 - Wireless Outdoor Sensor
 - Wireless Indoor Sensor
 - Wireless Entry/Exit Remote
 - Wireless Vent
 - Filter Boost Remote



Part #	Mfg #	Description	Price
173007	YTH8321R1002/U	3H/2C Heat Pump, 2H/2C ConvR,RC,C,W-O/B,W2-AUX/E,Y.Y2,G,A-L/A,K,U1,S1	

Thermostats

FocusPRO® 6000 5+2 or 5+1+1 Day Programmable Digital Thermostats

- Selectable to 5-1-1 (weekdays, Saturday, Sunday) or 5-2 (weekdays, weekend) programmable thermostat
- Large, clear, back light display - easy to read in various lighting conditions
- Display size options - available in large screen or standard
- Precise comfort control (+/- 1°F) - maintains consistent comfort to the highest level of accuracy
- Simplified programming and operation
- Easy change battery door - flips out without disassembling thermostat
- Built in instructions - simple, pull out instruction manual
- Adaptive Intelligent Recovery™ - ensures programmed temperature is reached by programmed time
- Temperature range stops - prevents user from setting the temperature too high or too low
- Temperature range:
 - Heat: 40° to 90°F
 - Cool: 50° to 99°F
- Dimensions: 3-9/16"H x 5-13/16"W x 1-1/2"D
- Premier White®
- 5-Year warranty



Large Display

HVAC - General Accessories

Part #	Mfg #	Application	Terminal Designations	Screen	Price
084585	TH6110D1005	1 Heat/1 Cool	Rc,R,W(O/B),C,Y,G	Standard	
086938	TH6110D1021	1 Heat/1 Cool	Rc,R,W(O/B),C,Y,G	Large	
084586	TH6220D1002	2H/2C Conv, 2H/1C Heat Pump	Rc,R,W(O/B),W2(AUX),Y,Y2(E),G,L,C	Standard	
173731	TH6220D1028	2H/2C Conv, 2H/1C Heat Pump	R, RC, C, W(O/B), G, Y, W2(AUX), E, Y2-L	Standard	
135014	TH6320U1000	2H/2C Conv, 3H/2C Heat Pump	Rc,R,W(O/B),W2(AUX/E),Y,Y2,G,L,C	Large	

FocusPRO® 5000 Non-Programmable Digital Thermostats

- Electronic control of 24VAC, heating and cooling systems or 750mV heating systems
- Clear back light display available with large (2.98 sq in) or standard (1.95 sq in) screen
- Precise comfort control +/- 1°F of your set temperature
- Temperature control range stops
- Soft-key, simplified controls
- Easy change battery door - flips out without disassembling thermostat
- Automatic/manual selectable changeover
- Dual-powered, battery or hardwired
- Built-in compressor protection: minimum-off timer protects compressor from restarting too early after a shutdown
- Temperature range:
 - Heat: 40° to 90°F
 - Cool: 50° to 99°F
- Dimensions: 3-7/16"H x 4-1/2"W x 1-5/16"D
- Premier White®



Standard Display



Large Display

Part #	Mfg #	Application	Terminal Designations	Screen	Price
079592	TH5110D1006	1 Heat/1 Cool	R,Rc,C,W(O/B),Y,G	Standard	
084587	TH5220D1003	2H/2C Conv, 2H/1C Heat Pump	Rc,R,W(O/B),W2(AUX),Y,Y2,(E),G,L,C	Standard	
098663	TH5220D1029	2H/2C Conv, 2H/1C Heat Pump	R,Rc,W(O/B),W2(AUX),Y,Y2,(E),G,L,C	Large	
105599	TH5320U1001	2H/2C Conv, 3H/2C Heat Pump	R,Rc,W(O/B),W2(AUX/E),Y,Y2,G,L,C	Large	

Thermostats

HVAC - General Accessories

PRO® 4000 5+2 Day Programmable Digital Thermostats

- Electronic control of 24VAC, heating and cooling systems or 750mV heating systems
- Weekday/weekend programming to fit your lifestyle
- Clear, back light display
- Precise comfort control +/- 1°F of your set temperature
- Easy slide switches allow selection of heat or cool mode, and fan operation
- Dual-powered, battery or hardwired
- Manual changeover
- Built-in instructions - simple, pull out instruction manual
- Adaptive Intelligent Recovery™ - ensures programmed temperature is reached by programmed time
- Temperature range:
 - Heat: 40° to 90°F
 - Cool: 50° to 99°F
- Dimensions: 3-13/16"H x 5-3/8"W x 1-1/4"D
- Premier White®



Part #	Mfg #	Application	Terminal Designations	Price
096358	TH4110D1007	1 Heat/1 Cool Conv & Heat Pump	Rc,R,W,Y,G,O,B,C	

PRO® 3000 Basic Non-Programmable Digital Thermostats

- Electronic control of 24VAC, heating and cooling systems or 750mV heating systems
- Digital back light display - both current and set temperature are easy to read
- Precise comfort control (+/- 1°F)
- Easy slide switches allow selection of heat or cool mode and fan operation
- Manual changeover
- Dual-powered, battery or hardwired
- Temperature range:
 - Heat: 40° to 90°F
 - Cool: 50° to 99°F
- Dimensions: 3-13/16"H x 5-3/8"W x 1-1/4"D
- Premier White®



Part #	Mfg #	Application	Terminal Designations	Price
104606	TH3110D1008	1 Heat/ 1 Cool Conventional & Heat Pump	R,Rc,W,Y,G,O,B,C	

Thermostats

PRO® 1000 Builder Series Non-Programmable Digital Thermostats

- Electronic control of 24VAC, heating and cooling systems or 750mV heating systems
- Perfect for multi-family housing developments or apartment complexes
- Clear, back light digital display
- Manual changeover
- Simple-set programming
- Dual-powered, battery or hardwired
- Temperature range:
 - Heat: 40° to 90°F
 - Cool: 50° to 99°F
- Dimensions: 4-11/16"H x 2-7/8"W x 1-1/8"D
- Premier White®



Part #	Mfg #	Application	Mount	Terminal Designations	Price
162924	TH1100DV1000	Heat Only	Vertical	R, C, W	

LineVoltPro™ 8000 Programmable Electric Heat Only Thermostats

- Use for electric baseboards, convectors and fan forced heaters (resistive rated loads)
- 7-Day preprogrammed schedule or modify programming to suit your lifestyle
- On-demand back light
- On/off switch and visible heat indicator
- Electrical rating: 15.0A
- 4-Wire/DPST Switching action



Part #	Mfg #	Description	Price
144533	TL8230A1003	7-Day Programmable Electric Heat, Premier White®	

LineVolt™ TH450/U Electric Manual Thermostat

- Electric heating, baseboard heater, convector or fan-forced heater
- Battery-free, min & max temperature locks
- Minimum Load: 1.25 A (resistive only) 300 W @240 Vac, 150 W @ 120 Vac, Maximum Load: 16.7 A (resistive only), 4000 W @ 240 Vac, 2000 W @ 120 Vac
- Temp range: 40 F to 85



Part #	Mfg #	Description	Price
181190	TH450/U	Line Voltage T-Stat, Non-Programmable	

HVAC - General Accessories

Thermostats

HVAC - General Accessories

**Thermostat Accessories
Universal Thermostat Guard**

- Tamper-resistant lock; key cannot be removed unless in locked position
- Vents in guard base allow airflow

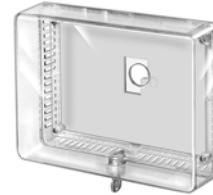

TG511A /TG512A

Part #	Mfg #	Description	Price
006787	TG511A1000	Fits Series TH3000, TH4000, TH5000, TH6000, TH8000 & Similar 6-1/2"H x 7-1/2"W x 2-15/16"D	
006788	TG512A1009	Fits Series TH5000, TH6000, TH8000 & Most Electronic Thermostats 7-1/4"H x 9-3/4"W x 3-3/8"D	

**Wireless Thermostat Systems
Prestige® IAQ Comfort System**

- 4 Heat/2 cool heat pump or up to 3 heat/2 cool conventional
- Powered by RedLINK™ reliability
- Wireless outdoor sensor
- Large back-lit color display shows current indoor temperature, humidity, temperature setting, date and time on the home screen (also displays outdoor temperature and humidity on home screen if wireless outdoor sensor is installed)
- Automatic daylight savings update
- Auto or manual changeover
- Change reminders for air filter, humidifier pad, ultraviolet bulb or batteries in connected devices
- 7-Day multiple day programming or non-programmable
- Humidity and dehumidity control
- 18 to 30VAC
- Arctic white



Part #	Mfg #	Description	Price
155759	YTHX9421R5101	Prestige HD IAQ Thermostat, Equipment Interface Module WW	
155758	YTHX9421R5085	Prestige HD IAQ Thermostat, 2-Wire Comfort System Kit WW	
155761	THX9421R5021W	Prestige HD IAQ Kit, w/ 2 Sensor 7-Day Programmable W	
223119	YTHX9421R5127	Prestige HD IAQ Kit, w/ RedLINK, 2-Wire Touchscreen, Interface Module, & Return Sensors WW	
171083	THP9045A1023/U	WireSaver for THX9000 Series Thermostats	

Thermostats

Honeywell IAQ Equipment Interface Module

- 4 Sensor inputs for wired sensors or dry contact devices
- 3 Sets of IAQ contacts to control humidification, dehumidification, and ventilation
- Used with all versions of Prestige IAQ thermostats and RedLINK™ VisionPRO thermostats
- 4 Heat/2 cool heat pump
- 3 Heat/2 cool traditional



HVAC - General Accessories

Part #	Mfg #	Description	Price
163861	YTHM5421R1010	Prestige 2-Wire IAQ Equipment Interface Module Kit w/ 2 Duct Sensors	
155767	THM5421R1021	3 Universal IAQ Contacts to control Humidification, Dehumidification, or Ventilation	

Wifi Heat and Cool Thermostat

FocusPRO® Thermostat Kit with RedLINK Internet Gateway

- Includes:
 - C7735A1000 Return Air Sensor
 - THM5320R1000 Equipment Interface Module
 - THM6000R1002 RedLINK Internet Gateway
 - (YTH6320R1114/U has TH5320R1002 Thermostat)
 - (YTH6320R1122/U has TH6320R1004 Thermostat)
- 3 Heat/2 cool heat pump or up to 2 heat/2 cool conventional



Part #	Mfg #	Description	Price
174483	YTH6320R1114/U	Includes TH5320R1002 Wireless Non-Programmable FocusPRO® Thermostat	
174484	YTH6320R1122/U	Includes TH6320R1004 Wireless 5+1+1 Programmable FocusPRO® Thermostat	

FocusPRO® Wireless Thermostat Kit

- Powered by RedLINK™ reliability
- Can display outdoor temperature and humidity
- 1-Year battery life, 2-month low battery warning



YTH5320R1000

YTH5320R1017

Part #	Mfg #	Description	Price
119159	YTH5320R1000	Includes TH5320R1002 Wireless Non-Programmable FocusPRO® Thermostat	
119158	YTH5320R1017	Includes TH5320R1002 Wireless Non-Programmable FocusPRO® Thermostat	
119161	YTH5320R1025	Includes TH5320R1002 Wireless Non-Programmable FocusPRO® Thermostat	
119090	YTH6320R1001	Includes TH6320R1004 Wireless FocusPRO® 5+1+1 Programmable Thermostat	
119089	YTH6320R1015	Includes TH6320R1004 Wireless FocusPRO® 5+1+1 Programmable Thermostat	

Thermostats

HVAC - General Accessories

Wi-Fi 9000 with Voice Control

- Change temperature with Voice Control (English only)
- Get Connected – Connect to homes existing Wi-Fi network
- Remote Control – Convenience, comfort and control from anywhere through web, tablet or smartphone access
- App available for tablet and smartphones
- Automatic software updates through Wi-Fi
- Selectable to 7 Day or Non-Programmable
- Program thermostat locally or over the web or app
- Customize the screen color to match any décor



Part #	Mfg #	Description	Price
167150	TH9320WFV	7-Day Program or Non-Programmable, Up to 2H/2C Conv or 3H/2C Heat Pump	

Wireless FocusPRO® Thermostat

- Compatible with gas, oil, electric, heat pump, forced warm air, hot water, steam or gravity
- Easily add a zone to a TrueZONE™ system without running new wires
- Powered by RedLINK™ reliability
- No interference with other wireless devices in the home
- Works with compatible RedLINK™ enabled devices
- Same great features of the FocusPRO® thermostat now wireless
- Installs in minutes
- Can display outdoor temperature and humidity (if wireless outdoor sensor is installed)
- Battery powered only
- 1-Year battery life, 2-month low battery warning
- Premier White®



TH5320R1002



TH6320R1004

Part #	Mfg #	Description	Price
119160	TH5320R1002	Non-Programmable, Up to 3 Heat/2 Cool Heat Pump or Up to 2 Heat/2 Cool Conventional	
119091	TH6320R1004	5+1+1 or 5+2 Day Programmable, Up to 3 Heat/2 Cool Heat Pump or Up to 2 Heat/2 Cool Conventional	
154516	TH6320WF1005	7-Day Program, Up to 3Heat/2 Cool Heat Pump or Up to 2 Heat/2 Cool Conventional	

Wireless Outdoor Temperature Sensor

- Powered by RedLINK™ reliability
- No interference with other wireless devices in the home
- Reliable performance in all climates
- Installs in minutes
- Up to 5-years battery life, 2-month low battery warning
- Battery warning displayed on RedLINK™ enabled thermostats
- Includes (2) AA Lithium batteries and mounting hardware



Part #	Mfg #	Description	Price
120395	C7089R1013	Wireless Outdoor Sensor, Senses Outdoor Temperature and Humidity, RedLINK™	

Thermostats

Personal Comfort Station™

- Works in both zoned and non-zoned applications
- Powered by RedLINK™ reliability
- Built in pager with an audible noise helps locate the device in the home
- Battery powered
- Touchscreen interface with back light display
- Can display outdoor temperature and humidity



Part #	Mfg #	Description	Price
120396	REM5000R1001	Portable Comfort Station Control, RedLINK™ Enabled	

RedLINK™ Equipment Remote Module

- Wireless RedLink™ communication between condensing unit/compressor or boiler and thermostat
- Eliminates the need to run additional wires to your equipment
- Suitable for outdoor use
- Temperature sensor terminals for outdoor temp sensors or indoor freeze protection
- LEDs for easy installation checkout
- May reduce damage to homes since wiring/drilling is eliminated
- Erm is NOT compatible with RedLink Zone Boards



Part #	Mfg #	Description	Price
189864	ERM5220R1018	Wireless RedLink™ communication between condensing unit/compressor or boiler and thermostat	

RedLINK™ Internet Gateway

- Provides remote access to any RedLINK® enabled thermostat through the internet, smart phone or tablet
- Includes 3' Ethernet cable and plug-in power adapter
- Operating temperature: 32° to 120°F



Part #	Mfg #	Description	Price
143270	THM6000R1002	Up to 4 Heat/2 Cool Heat Pumps	

RedLINK™ Wireless Indoor Air Sensor

- Used to change the sensing location of the thermostat
- Works with RedLINK™ 2.0 thermostats
- Sense temperature and humidity remotely
- Control temperature and humidity in separate locations
- Humidify and dehumidify in separate locations
- Up to (6) wireless sensors per thermostat
- Dimensions: 2-7/8"H x 1-7/8"W x 15/16"D
- Operating temperature: 0° to 120°F
- Includes:
 - (2) AAA Batteries
 - Mounting hardware



Part #	Mfg #	Description	Price
143274	C7189R1004	RedLINK™ Wireless Indoor Sensor	

HVAC - General Accessories

Thermostats

HVAC - General Accessories

TrueIAQ™ Total Home Comfort System

- Manages humidification, dehumidification, ventilation and bathroom fans from a central point in your home
- Setting changes can be made easily with the touch of a button
- Simultaneously displays both indoor and outdoor temperature and humidity levels on-screen
- Automatically adjusts inside settings based on outdoor conditions
- Include individual air quality enhancements to your system with TrueIAQ™, or integrate them all as part of a total air quality system
- Intuitive digital back light display.



Part #	Mfg #	Description	Price
111238	DG115EZIAQ	Steam Type, 120VAC, Duct or Remote Mount with Outdoor Temperature/Humidity Sensor, White	

Temperature Sensors

C7089 Remote Outdoor Temperature Sensor

- Senses outdoor temperature for display; can manage dual-fuel and lock-out auxiliary heat in heat pump applications
- Maximum wire run of 200'
- Includes 60" lead wire, mounting clips and screws
- Dimensions: 2-1/4" x 3/8" with 60" lead wire
- Factory calibrated

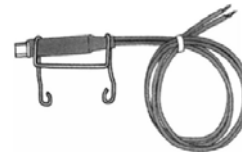

Part #	Mfg #	Description	Price
078072	C7089U1006	For VisionPRO® & VisionPRO® IAQ Thermostats	

PT1000 Duct TempSensor

- Electronic temperature sensors used with DDC systems
- PT1000 Tempsensor, 6" insertion
- Use w/ T775, operating range -40-250F



Part #	Mfg #	Description	Price
190400	C7031B2005/U	For Duct, Use with Excel 10, 50, 80, 100, 500, T775 Series 2000	

C7041 Immersion Sensor

- 20K ohm NTC temp sensor, 5 in. insertion
- Immersion sensor for hot or chilled water, purchase well 50001774-001 separately



Part #	Mfg #	Description	Price
190399	C7041D2001/U	For Excel 10, 50, 80, 100, 500	

Thermostats

Outdoor Air Temperature Sensor

- Electronic temperature sensors used with DDC systems
- 1715 ohm, for use with W7100 (outdoor reset)
- Outside air temperature



Part #	Mfg #	Description	Price
190401	C7031G2006/U	1715 ohm Outdoor Air Temperature Sensor, for use with W7100	

Discharge Temperature Sensor

- Primary and/or secondary sensors in electronic control systems
- No settings or calibration required.
- Solid state components not affected by dust or dirt.
- Fast reacting.
- Rugged aluminum insertion probe.
- Mounts on duct or plenum surface with integral mounting flange, or in a 2 x 4 in. junction box.



Part #	Mfg #	Description	Price
190397	C7046D1008/U	1097 ohm @ 77 F PTC, Excel 600, Excel 500, Excel 100, Excel 80, and T775 Series 2000	

C7189 Remote Indoor Sensor

- Mounts in living space up to 200' away from W8900 remote module



Part #	Mfg #	Description	Price
078076	C7189U1005	For VisionPRO and VisionPRO IAQ Thermostats	

HVAC - General Accessories

Commercial Thermostats

HVAC - General Accessories

Programmable Commercial Thermostats

TL8100 Hydronic 7-Day Programmable Electronic Thermostat

- Controls 2- or 3-way zone valves or circulator pumps in both line and low volt
- Special protection modes to prevent system seizures and reduce call backs
- Easy to install
- Millivolt compatible
- Electrical ratings: maximum load: 5A (resistive), 2A (inductive) @ 24VDC, 120VAC and 240VAC



Part #	Mfg #	Description	Price
128315	TL8100A1008	Programmable Electronic Thermostat, White	

Line Voltage Commercial Thermostats

T451 Medium-Duty Line Voltage Commercial Thermostat with Thermometer

- SPST Switching action, makes on temperature fall, breaks on temperature rise
- Heating application
- Control line voltage on valves, motors, contactors, electric heat elements, duct furnaces and fan coil units
- Mounts on standard vertical or horizontal outlet box
- Includes vertical scale plate with thermometer and high accuracy dual diaphragm sensor
- Dimensions: 4-1/2"H x 2-15/16"W x 1-1/2"D (switches and wiring terminals protrude into outlet box 3/4")
- Champagne gold faceplate with beige cover



Part #	Mfg #	Temp Setting	Description	Price
065237	T451A3005	44° - 86°F	Range Stops, Locking Cover Screws & Wall Plate	

T651A Light-Duty Line Voltage Commercial Thermostat

- Control line voltage on valves, motors, contactors, electric heat elements, duct furnaces and fan coil units
- SPDT Switching action, breaks heating and makes cooling on temperature rise
- Heating and cooling application
- Mount on standard vertical or horizontal outlet box
- Automatic cooling and heating anticipation
- Includes vertical scale plate with thermometer, horizontal scale plate without thermometer, and high accuracy dual diaphragm sensor
- Dimensions: 4-1/2"H x 2-15/16"W x 1-1/2"D (switches and wiring terminals protrude into outlet box 3/4")
- Champagne gold faceplate with beige cover



Part #	Mfg #	Temp Setting	Description	Price
065613	T651A3018	44° - 86°F	Range Stops, Locking Cover Screws & Wall Plate	

Commercial Thermostats

T631A-C Farm Controller

- Provides line voltage control of heating, cooling and ventilating systems in farm buildings or storage areas
- Light-duty line volt thermostat, 2°F fixed differential
- Treated to resist corrosion



Part #	Mfg #	Description	Price
006794	T631A1006	Farm-O-Stat, 35° - 100°F, SPDT Snap Switch, Red	

Winter Watchman

- Used as freeze warning device
- Completes circuit to household lamp on temperature fall, indicating inoperative heating equipment



Part #	Mfg #	Description	Price
006784	S483B1002	Winter Watchman Freeze Warning Device, 30° - 60°F, Adjustable	

Thermostat Cover Plates

Thermostat Cover Plate for FocusPRO® & PRO® Series

- Small cover plate: 4-5/16"H x 5-1/2"W
- Medium cover plate: 5"H x 6-7/8"W
- Large cover plate: 6"H x 8-5/16"W
- Premier White®

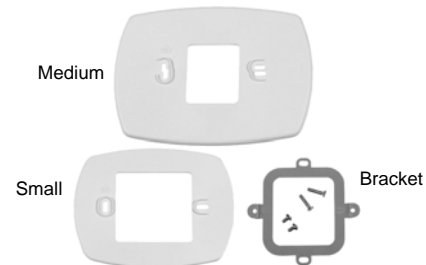

Part #	Mfg #	Description	Price
079594	50001137-001	For TH5110 Thermostat	
079595	50002883-001	For FocusPRO® 6000/5000, PRO® 4000/3000	

HVAC - General Accessories

Pro1 Thermostats

Pro1 Thermostats

- Separate heating and cooling swing adjustments
- Battery or 24V power
- 5-Year warranty

T700 Thermostat

- Blue backlight with glow-in-the-dark light button
- Easy access battery compartment
- Electric or gas configurable
- Simple private label badge system
- Separate B & O terminals
- Easy wire color-coded terminal blocks
- Room temperature calibration adjustment
- 5-Minute compressor delay protection
- Universal sub-base
- Mounts on wall or junction box



T701/T771/T721



T705/T715



T755/ T755H

Part #	Mfg #	Stages	Programs	Description	Price
138686	T701	1 Heat/1 Cool	Non-Programmable	Single-Stage	
138687	T705	1 Heat/1 Cool	5+1+1	Single-Stage	
138688	T715	2 Heat/2 Cool	5+1+1	Multi-Stage	
182210	T721	2 Heat/1 Cool	Non-Prgrammable	Single-Stage	
138690	T755	3 Heat/2 Cool	5+1+1 or Non-Programmable	Heat Pump	
140228	T755H	3 Heat/2 Cool	5+1+1 or Non-Programmable	Universal	
138691	T771	1 Heat/1 Cool	Non-Programmable	Single-Stage	

T800 Thermostat

- Blue backlight with glow-in-the-dark light button
- Easy access battery compartment
- Extra large, easy-to-read temperature display
- Electric or gas configurable
- Simple private label badge system
- Separate B & O terminals
- Easy wire color-coded terminal blocks
- Room temperature calibration adjustment
- 5-Minute compressor delay protection
- Universal sub-base
- Mounts on wall or junction box



Part #	Mfg #	Stages	Programs	Description	Price
138693	T805	1 Heat/1 Cool	5+1+1	Single-Stage	
138694	T855	2 Heat/2 Cool	7-Day or 5+1+1	Universal	

HVAC - General Accessories

Pro1 Thermostats

T900 Thermostat

- Touchscreen with blue backlight and glow-in-the-dark light button
- Auto changeover
- Easy access battery compartment
- Electric or gas configurable
- Filter change indicator
- Simple private label badge system
- Keypad lockout
- Separate B & O terminals
- Easy wire color-coded-terminal blocks
- Room temperature calibration adjustment
- 5-Minute compressor delay protection
- Universal sub-base
- Mounts on wall or junction box



HVAC - General Accessories

Part #	Mfg #	Stages	Programs	Description	Price
138905	T925	3 Heat/2 Cool	7-Day or 5+1+1	Heat Pump	

T955W Wireless Thermostat

- 13" Touchscreen display with blue backlight and glow in the dark light button
- Set dual fuel balance points
- Connects up to 4 indoor remotes (R251W)
- Connects to outdoor remotes (R250W)
- Auto changeover
- Programmable fan
- Electric or gas configurable
- Heating and cooling setpoint limit
- Room temperature calibration adjustment
- 5 Minute compressor delay protection
- Mounts on junction box



Part #	Mfg #	Stages	Programs	Description	Price
159881	PD411093	3 Heat/2 cool	7-Day, 5+1+1 or Non-Programmable	Universal with Humidity Control	

Thermostat Accessories

Wireless Wire® Base Module

- Replaces 25V wire
- Input module: 7 terminal inputs and 2 terminal outputs
- Output module: 7 terminal outputs and 2 terminal inputs



Part #	Mfg #	Description	Price
138696	WW160W	Includes Both Input Base Module and Output Base Module	

Pro1 Thermostats

Remote Temperature Sensor



Indoor



Outdoor

Part #	Mfg #	Description	Price
138685	PD411070	Remote Indoor Sensor	
138683	PD411071	Remote Outdoor Sensor	

HVAC - General Accessories

Protech Thermostats

Thermostats

200 Series Universal Programmable Thermostat

- Universal choice of 7-day, 5+1+1 or 5+2 programmable or non-programmable
- 4 Time and 4 temperature settings per program (heat & cool)
- 4" Lighted blue display
- Permanent program retention
- Battery/hardwired



Part #	Mfg #	Description	System	Type	Price
131301	UHC-TST213UNMS	2 Heat/2 Cool	Universal (AC/HP/GE)	Multi-Stage	

400 Series Special Deluxe Programmable Thermostat

- Hardwired power source
- Lighted display



Part #	Mfg #	Description	System	Type	Price
124272	UHC-TST412MDMS	1 Heat/2 Cool	Dual Fuel	Multi-Stage	

500 Series High Definition Communicating Thermostat

- Universal choice of 7-day, 5/2 day programmable or non-programmable
- Dehumidification and humidification control
- Outdoor temperature display
- Intelligent scheduling ramp-up/program anticipation
- USB connection for uploading of programming and configuration
- Maintenance reminders
- Compressor short cycle protection
- 5-Year limited warranty



RHC-TST550CMMS

Part #	Mfg #	Description	System	Type	Price
126929	UHC-TST550CMMS	2 Heat/2 Cool	Dual Fuel	Dehumidification & Humidification	

500 Series Touchscreen Communicating Thermostat

- Scrolling system status
- Dehumidification control
- Armchair programming allows users to remove thermostat from wall to set the schedule
- Outdoor temperature display
- Intelligent scheduling ramp-up/program anticipation
- Maintenance reminders
- Compressor short cycle protection
- 5-Year limited warranty



Part #	Mfg #	Description	System	Type	Price
131449	UHC-TST501CMMS	4 Heat/2 Cool	Dual Fuel	Dehumidification	

HVAC - General Accessories

Protech Thermostats

HVAC - General Accessories

**EcoNET™ Control Center
Home Control with Intuitive LCD Touchscreen Navigation**

- Added support for new EEV Air Handlers, Air Conditioners and Heat Pumps
- Rapid installation with standard 4-wire configuration
- Automatically configures communicating equipment with optimal settings
- Adapts to home decor through interchangeable faceplates and adjustable background coloring
- Full-color: 4.7" LCD touchscreen display with easy-to-read icons and text
- Convenient date, time and indoor/outdoor temp indications
- 5 operating modes with short-cycle protection (Heat, Cool, Auto, Emergency, Heat, Fan Only)
- 7-Day programmable schedule
- Detailed operating status, alarm history, and audible alerts
- Supports humidifier accessories or over-cool based dehumidification
- Easily manage from anywhere with the compatible WiFi Module & EcoNet app
- 5-Year Warranty



Part #	Mfg #	Description	Price
176844	UETST601SYS	Compatible w/ select HVAC and Water Heating Products, and the new R96V Furnaces	

EcoNet WiFi Kit

- Enables remote operation
- WiFi Kit Components:
 - EcoNet WiFi Module
 - Installation Instructions
 - V Power Adapter
 - Junction Box
 - 24" Port to Port Connection Cable
 - 1" x 2" Double Adhesive Mounting Tape
 - RJ12 Y Splitter (for use with communicating electric water heaters)



Part #	Mfg #	Description	Price
174498	REWRA630SYS	Works with any HVAC system which includes an EcoNet Enabled Furnace or Air Handler	



Ruud Thermostats

Thermostats

300 Series Deluxe Programmable Thermostat

- Universal programming, choice of 7-day, 5+2 or non-programmable
- 12 Sq inch touchscreen display
- Larger, easy-to-read character size
- Keypad lockout option
- Dual power - hardwired or battery
- Easy, menu-drive programming
- Audio prompting to ensure program change confirmation
- Intuitive red/blue temperature keys
- 5-Year warranty from date of purchase



HVAC - General Accessories

Part #	Mfg #	Description	Price
123952	UHC-TST305UNMS	4 Heat / 2 Cool Gas, Oil, Electric, Heat Pump, Dual Fuel	

White-Rodgers Thermostats

80 Series® Blue 2" Thermostats

- 2" Wide LCD lighted screen
- Fossil fuel or electric heat compatible
- Dual powered, choice of battery or hardwired for all applications
- Easy push-connect color coded terminals
- Cool Savings™
- Dimensions: 3.8"H x 4.8"W x 1.5"D
- Classic white color
- 5-Year warranty



Part #	Mfg #	System	Program Options	Additional Applications	Power Source	Terminal Designations	Price
127608	1F86-0244	1 Heat/1 Cool	Non-Prog	mV	Battery/Hardwire	R,C,W,Y,G,O/B	

Thermostat Wire

**Genesis Cable
Mini Split Cable**

- For mini-split systems
- Sunlight resistant
- RoHS Compliant PVC jacket
- 600V Direct burial
- Operating temperature: -4° to 194°F
- UL Listed



Part #	Mfg #	Description	Price
120933	1070-01-08	14 AWG 4/C Solid, 250' Spool	

Jacketed Cables Shielded (Overall Shield) - CL2 Rated

- For wiring of thermostat controls, heating & air conditioning equipment, doorbells, and other low voltage applications
- Sunlight resistant
- Copper conductors, polypropylene insulation & polyvinyl-chloride jacket



Part #	Mfg #	Description	Price
131441	1216-03-09	18 AWG 6/C Stranded OAS, 250'	

Jacketed Cables Overall Shield - CL2P Rated

- For wiring of burglar alarms, public address systems, intercoms, telephone stations, speakers, instrumentation, control and other low voltage circuits that are power-limited
- Sequential footage markings
- Twisted copper conductors, low smoke PVC insulation, aluminum/mylar shield, low smoke PVC jacket



Part #	Mfg #	Description	Price
010365	4710-48-07	18 AWG 2/C Solid, 500' Spool	
010366	4711-48-07	18 AWG 3/C Solid, 500' Spool	
010367	THERMWIRE4	18 AWG 4/C Solid, 250' Spool	
010368	4713-03-07	18 AWG 5/C Solid, 250' Spool	
029999	4714-03-07	18 AWG 6/C Solid, 250' Spool	
030000	4716-03-07	18 AWG 8/C Solid, 250' Spool	
117899	4718-03-07	18 AWG 10/C Solid, 250' Spool	

Jacketed Stranded Shielded (OAS) CM/CL2 (PVC) Cable

- 1000ft - 22/1pr
- Grey Jacket
- HVAC applications
- AWG: 22



Part #	Mfg #	Description	Price
155918	10631109	22 AWG CM/CL2, 1000'	

HVAC - General Accessories

Thermostat Wire

Tracer Wire

- For water pipes, fiber optics, gas pipes, and dog containment systems
- Polyethylene insulation
- 600V Direct burial
- UL Listed

Part #	Mfg #	Description	Price
104923	13045006	12 AWG 1/C Solid, 500' Blue	
159042	13045002	500' Yellow	

HVAC - General Accessories

Transformers

Transformers

AT72 NEMA Standard Transformer

- 24V Control circuit step-down transformer designed to power any 24V control system, including thermostats, gas valves and relays
- NEMA Type D, meets NEC Class 2 Not Wet, Class 3 Wet and UL 1585 requirements
- Color-coded lead wire for primary connections
- 9" Lead wire (primary)
- Combination mount can be foot-mounted, plate-mounted on 4 x 4", 4" octagon or 2" x 4" electrical boxes (transformer all above or 3/4 above plate) or clamp-mounted via a junction box knockout



Part #	Mfg #	Output (100 % Factor)	Primary Voltage @ 50/60 Hz	Secondary Voltage (Open Circuit)	Mounting	Electrical Connections Secondary	Price
006714	AT72D1683	40VA	120V	26.5	Combination	(2) Screw Terminals	
006715	AT72D1691	40VA	208/240V	26.5	Combination	(2) Screw Terminals	

AT87 NEMA Standard Transformer

- Used primarily for powering 24V air conditioning circuits
- NEMA Type E, meets NEC Class 2 Not Wet, Class 3 Wet and UL 1585 requirements
- Overload protection provided
- Color-coded lead wire for primary connections
- 13" Lead wire, built-in protection, primary winding burnout

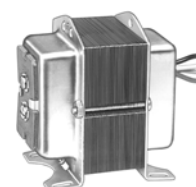

Part #	Mfg #	Output (100 % Factor)	Primary Voltage @ 50/60 Hz	Secondary Voltage (Open Circuit)	Mounting	Electrical Connections Secondary	Price
006717	AT87A1106	50VA	120/208/240V	26.5	Foot or 4" x 4" Plate	(2) Screw Terminals	

AT175A Class 2 General Purpose Transformer

- Color-coded lead wire for primary connections
- 9" Leads (primary)
- Screw terminal secondary
- UL Listed, CSA certified



AT140A



AT175A

Part #	Mfg #	Output (100 % Factor)	Primary Voltage @ 60 Hz	Mounting	Price
006713	AT140A1000	40VA	120V	Universal-Mount (Plate, Foot & K/O)	
098836	AT140A1018	40VA	120/208/240V	Universal-Mount (Plate, Foot & K/O)	
098838	AT175A1008	75VA	120/208/240V	Universal-Mount (Plate, Foot & K/O)	

HVAC - General Accessories

Transformers

AT150F/AT175F Circuit Breaker Transformer

- 9" Leads on primary and secondary
- Includes circuit breaker button
- UL Listed, CSA certified

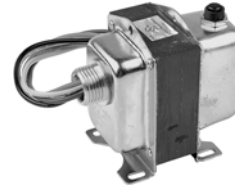

HVAC - General Accessories

Part #	Mfg #	Output (100 % Factor)	Primary Voltage @ 60 Hz	Mounting	Price
120399	AT150F1022	50VA	120/208/240V	Conduit & Foot-Mount	

Transformers

Transformers
620 Transformer
Foot Mounted Model

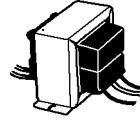

HVAC - General Accessories

Part #	Mfg #	VA Rating	-----Blower----- Voltage (50/60Hz)	Lead Length	Price
044319	620-405	40	120V	8"	



Transformers

Parts & Accessories Transformer

Part #	Mfg #	Description	Price
107986	46-101496-01	120V-24V 40VA Fused Control Transformer (OEM Mount), Leads with 1/4" Insulated Female Quick Connects	
094838	46-101905-01	208/230V Primary 24V Secondary 40VA Transformer	
094839	46-101944-02	120V Transformer	
145468	46-102856-01	Transformer	
037653	46-22863-04	Transformer	
055227	46-23115-02	208/230V-24V 40VA Transformer (OEM Mount), Leads with Stripped Ends	
020764	46-25107-02	Transformer	
030177	46-25107-03	Transformer	
141189	46-25107-04	120/208/240V-24V 40VA Transformer (Channel Mount - 2-Hole), Leads with Stripped Ends	
141509	46-25107-12	120/208/230/460V-24V 75VA Transformer (Channel Mount - 2-Hole), Leads with Stripped Ends	
172658	46-102856-02	120V Primary 24V Secondar 50VA Transformer	

HVAC - General Accessories

Universal Ignition Modules

Ignition Pilot Modules

Y8610U Universal Retrofit Intermittent Pilot Gas Burner Ignition System

- Complete kit for converting conventional standing pilot systems to intermittent pilot systems
- For use with 24VAC gas-fired atmospheric furnaces, boiler and heating appliances
- Includes:
 - S8610U Intermittent pilot module
 - VR8304M Dual valve combination gas control or VR8204A dual valve combination gas control
 - 392431 Igniter sensor
 - 394800-30 Ignition cable
 - 393691 Natural to LP gas conversion kit
 - Wiring harness
 - 393690-14 3/4" Straight flange kit
 - Reducer adapters for gas control with VR8304M
 - Installation hardware

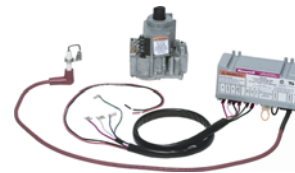

HVAC - General Accessories

Part #	Mfg #	Description	Price
021614	Y8610U6006	Y-Pack Containing S8610U3009 & VR8304M w/1/2" x 3/4" Inlet/Outlet, Flange Kit, LP Conversion Kit	

S8610U Universal Intermittent Pilot Module

- Field service replacement for most Honeywell, Robert Shaw, Johnson and UTEC (HSC) intermittent pilot ignition modules
- Provides electronic control of most intermittent pilot ignition systems used on gas-fired furnaces, boilers and other heating appliances
- For use in systems with combination igniter-sensor (single rod or dual rod sense)
- 100% Pilot gas shut-off and lockout on loss of pilot flame
- Includes relay contacts for use with any intermittent pilot gas control string with max 1.0A pilot or 2.0A main valve rating
- Honeywell VR8204, VR8304 or VR8345M combination gas control recommended
- Functional equivalent of S86, S8600, S8610 and S90 modules
- Includes spark cable adapters to allow field replacement of both Honeywell and competitive controls without replacing existing spark cable
- Includes damper connection and automatic vent damper plug



Part #	Mfg #	Description	Price
102849	S8610U3009	NG or LP Gas, 90 Second Trial for Ignition, 6-Minute Wait, Continuous Retry (Replaces S8610U1003)	

Universal Ignition Modules

HVAC - General Accessories

S8910U Universal Hot Surface Ignition Module

- Provides operating control of a direct ignition system using 120VAC hot surface igniter
- Replaces most hot surface ignition modules manufactured by Honeywell, Robert Shaw and White-Rodgers
- For local (single rod) or remote (dual rod) rectification type flame sensing
- For use only in 60Hz systems
- Provides (1) or (3) ignition trials (4-second or 7-second trials) per call for heat; pre purge of 32-seconds or less; up to 96-seconds between purge trial times
- Number of trials for ignition and trial time is determined by the selection tab. If a selection tab is not installed, the module will operate at 4-seconds trial time and (1) ignition trial
- Temperature range: -40° to 175°F

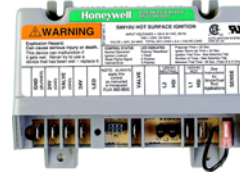

Part #	Mfg #	Description	Price
016077	S8910U1000	1.5 Second Flame Failure Response Time	

S9200U Hot Surface Ignition Control

- Universal hot surface ignition integrated furnace control
- Controls a standard induction-type circulating fan motor
- Can be used with conventional thermostats as well as the EnviraCOM™ enable VisionPRO IAQ and FocusPRO
- Main burner ignition using a 120V hot surface igniter
- Flame rectification circuit to monitor flame presence
- Monitors system pressure switch, high temperature limit, and Rollout functions



Part #	Mfg #	Description	Price
110086	S9200U1000	Universal Integrated Furnace Control	

Universal Ignition Modules

**Pilot Ignition
Automatic Pilot Relight Kit**



Part #	Mfg #	Description	Price
044310	785-001	24/120V Includes Igniter Assembly & Mounting Bracket	

780-910 Universal Hot Surface Ignition Module Uni-Kit®

- Local or remote flame sensors
- 1 or 3 Ignition attempts
- 17 or 34 Second igniter warm-up time
- 34 seconds or less prepurge
- Natural or LP gas controls
- 120VAC



Part #	Mfg #	Description	Price
044309	780-910	100% Lockout/Complete Gas Shutoff if Main Burner Does Not Light After the Selected Trial f/Ignition Sequence Has Been Completed	

HVAC - General Accessories

Wire Nuts & Leads

Wire Connectors

Screw-On Wire Connector

- Color-coded connector shells
- Heat resistant up to 221°F
- Resists practically all chemical action
- Unaffected by gasoline, oils, diluted acids and alkaline solutions



HVAC - General Accessories

Part #	Mfg #	Description	Price
139015	8651	Blue, #22 - #14 AWG, Min 3 #22, Max 2 #16, 300V	
139016	8652	Orange, #22 - #14 AWG, Min 3 #22, Max 3 #16 & 1 #18, 600V	
139017	8653	Yellow, #18 - #12 AWG, Min 1 #14 & 1 #18, Max 2 #14 & 3 #16, 600V	

Wire Ties & Connectors

Wire Ties
Stainless Steel Wire Tie

Part #	Mfg #	Description	Price
140499	455060	7.5", 250 lb Tensile Strength, 50/Pk	
140500	455061	14.5", 250 lb Tensile Strength, 50/Pk	

Nylon Wire Tie

Part #	Mfg #	Description	Price
140502	455063	4" Natural, 100/Pk	
140503	455064	4" UV Black, 100/Pk	
140504	455065	5.5" Natural, 100/Pk	
140506	455066	5.5" UV Black, 100/Pk	
140507	455067	7.5" Natural, 100/Pk	
140508	455068	7.5" UV Black, 100/Pk	
140509	455069	11.5" Natural, 100/Pk	
140510	455070	11.5" UV Black, 100/Pk	
140513	455071	14.5" Natural, 100/Pk	
140514	455072	14.5" UV Black, 100/Pk	
140515	455073	7.5" UV Black, Screw Mount-Heat, 100/Pk	

HVAC - General Accessories

Vibration Pads

HVAC - General Accessories

Anti-Vibration Pads

- Reduces vibration and noise from air-conditioning and refrigeration equipment
- Compounded for excellent resistance to aging, compression set and oil

Cork/Rubber Anti-Vibration Pad

- Solid cross-ribbed design (3/8" thick)
- Ribbed design with cork center (7/8" thick)

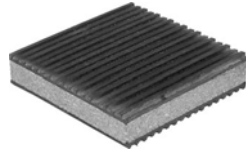

Part #	Mfg #	Size	Price
095859	6132	2" x 2" x 7/8"	
120264	6133	3" x 3" x 7/8"	
027603	6134	4" x 4" x 7/8"	

All Rubber Anti-Vibration Pad

- Has a solid cross-ribbed design (3/8" thick)

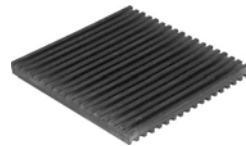

Part #	Mfg #	Size	Price
002304	6438	18" x 18" x 3/8"	

Zone Dampers & Accessories

Wifi Heat and Cool Accessories

TrueZONE™ Wireless Zoning Kit

- Includes TrueZONE panel, AT140 40VA transformer and C7735A discharge air temperature sensor



Part #	Mfg #	Description	Price
111211	HZ311K	For Conventional, Single-Stage Applications up to (3) Zones	
111209	HZ322K	For Conventional & Heat Pump Applications up to (3) Zones (2 Heat/2 Cool)	
111207	HZ432K	For Conventional, Heat Pump or Dual Fuel Applications up to (32) Zones (3 Heat/2 Cool)	

Wireless RedLINK™ Adapter

- Allows you to easily add RedLINK™ enabled thermostats to a TrueZONE™ system without running new wires



Part #	Mfg.#	Description	Price
129308	THM4000R1000	Add RedLINK™ Enabled Thermostats to a TrueZONE™ System	

TrueZONE™ Panel

- Universal application
- Robust push terminals
- Common-sense LED's
- Clean, professional installation
- Smaller footprint
- Auto changeover
- Variable-speed fan control
- Discharge air temperature compatible
- Resettable fuse
- Individual zone fan control



Part #	Mfg #	Description	Price
111206	HZ432	3 Heat/2 Cool Conv, Heat Pump or Dual Fuel, 4-Zone Expandable, Standard Checkout Procedure	

HVAC - General Accessories

Zone Dampers & Accessories

HVAC - General Accessories

Communicating Programmable Thermostats

VisionPRO® IAQ Communicating Touchscreen Digital 7-Day Programmable Thermostat

- Electronic control of 24VAC heating and cooling systems in addition to humidification, dehumidification and ventilation control with just 3 wires to the thermostat in conventional and heat pump systems
- 7-Day multiple day programming or non-programmable
- For use with W8835A Envirazone Panel and THM5421C1008 equipment interface module
- Eliminate the need for fossil fuel kit
- Clear back light display available in large or standard screen
- Precise Comfort control +/- 1°F of your set temperature
- Temperature range:
 - Heat: 40° to 90°F
 - Cool: 60° to 99°F
- Automatic/manual selectable changeover
- Premier White®
- 5-Year warranty



Part #	Mfg #	Description	Price
103348	TH9421C1004	Up to 3 Heat/2 Cool Conventional, up to 4 Heat/2 Cool in Heat Pump Mode	

EnviraZone System Saver Kit

- Networked zoning kit includes:
 - Panel (W8835)
 - Transformer (AT140A)
 - Discharge air temperature sensor (C7835)
 - Outdoor temperature sensor (C7089U)
 - Outdoor temperature interface module (50022037-001)
- Heat pump compatible
- 3 Heat/2 cool stages



Part #	Mfg #	Description	Price
102165	Y8835A1044	2-Zone Kit with (2) TH9421C1004 VisionPRO IAQ Thermostats	

Wifi Temperature Sensors

C7735A1000 Discharge Air Temperature Sensor

- Use with THM5320R1000 Equipment Interface Module; TH6320R1004 or TH5320R1002 Wireless FocusPRO® Thermostat
- Mount on return duct for backup control of non-zoned systems RedLINK™ enabled wireless systems
- Works with EIM to maintain safe indoor temperatures if power is lost at the wireless thermostat
- Operating temperature range: 0° to 200°F
- Dimensions: 3-7/8"H x 4-1/8"W x 1-1/4"D
- Gray



Part #	Mfg #	Description	Price
068726	C7735A1000	Discharge Air Temperature Sensor, Includes Mounting Hardware	

Zone Dampers & Accessories

Zone Control Dampers
Automatic Round Damper

- Galvanized steel, single-blade damper
- Side or top motor mount
- Used with Honeywell zoning systems
- 24V, 60Hz, 2-Position motor type, (2) wires to motor



Part #	Mfg #	Size	Price
179708	ARD6TZ/U	6"	
179709	ARD8TZ/U	8"	
179704	ARD10TZ/U	10"	
179705	ARD12TZ/U	12"	
179707	ARD14TZ/U	14"	

Retrofit Round Damper

- Inserts into rigid round ducts for retrofit zoning in forced air heating and cooling
- Power open, power closed actuator draws 2.5 VA allowing multiple dampers per zone



Part #	Mfg #	Size	Price
104578	RRD6	6"	

TrueZONE® Bypass Pressure Regulating Damper

- Quick installation and setup
- No weight to adjust
- Can be installed in any orientation
- Engineered to provide constant system pressure regardless of changes in zones ceiling or blower speed



Part #	Mfg #	Size	Shape	Price
155823	CPRD8U	8"	Round	
155822	CPRD10U	10"	Round	
155824	CPRD12U	12"	Round	
155885	CPRD14U	14"	Round	

HVAC - General Accessories

Zone Dampers & Accessories

ZD Series Damper

- Power close, spring open
- 24V Spring-return motor used to control circulating air in HVAC systems
- Used when a normally open damper is required, typically used with the TrueZONE™ systems and other electronic zoning damper systems
- Kevlar gearing reduces wear, more than doubling damper life
- Adjustable range stops
- Mechanical visual position indicator for damper status
- Solid construction using extruded aluminum frame and blades
- Parallel blade design for low leakage performance
- Quieter operation with fewer blades
- Simple, easy-to-wire, 2-wire installation
- Compatible with conventional and networked zoning
- Ordering Instructions: Order ZD + dimension 1 x dimension 2; note: motor is always mounted on dimension 2 side
- Damper can be installed in any orientation (mounting side can be on either the bottom or the side of the duct)



HVAC - General Accessories

Part #	Mfg #	Size	Shape	Motor Mount	Price
179655	ZD8X8TZU	8" x 8"	Square	Side	
179656	ZD8X10TZU	8" x 10"	Rectangular	Bottom	
179657	ZD8X12TZU	8" x 12"	Rectangular	Bottom	
179658	ZD8X14TZU	8" x 14"	Rectangular	Bottom	
179659	ZD8X16TZU	8" x 16"	Rectangular	Bottom	
179660	ZD8X18TZU	8" x 18"	Rectangular	Bottom	
179661	ZD8X20TZU	8" x 20"	Rectangular	Bottom	
179662	ZD8X22TZU	8" x 22"	Rectangular	Bottom	
179663	ZD8X24TZU	8" x 24"	Rectangular	Bottom	
179703	ZD8X24TZU	8" x 28"	Rectangular	Bottom	
179664	ZD10X8TZU	10" x 8"	Rectangular	Side	
179697	ZD10X10TZU	10" x 10"	Square	Side	
179698	ZD10X12RZU	10" x 12"	Rectangular	Bottom	
179694	ZD10X14TZU	10" x 14"	Rectangular	Bottom	
179695	ZD10X16TZU	10" x 16"	Rectangular	Bottom	
179699	ZD10X20TZU	10" x 20"	Rectangular	Bottom	
179700	ZD10X24TZU	10" x 24"	Rectangular	Bottom	
179665	ZD12X8TZU	12" x 8"	Rectangular	Side	
179666	ZD14X8TZU	14" x 8"	Rectangular	Side	
179667	ZD16X8TZU	16" x 8"	Rectangular	Side	
179668	ZD18X8TZU	18" x 8"	Rectangular	Side	
179669	ZD20X8TZU	20" x 8"	Rectangular	Side	
179701	ZD20X10TZU	20" x 10"	Rectangular	Side	
179670	ZD22X8TZU	22" x 8"	Rectangular	Side	
179671	ZD24X8TZU	24" x 8"	Rectangular	Side	

Zone Dampers & Accessories

Damper Actuators

M847D 24VAC Spring Return Damper Actuator

- 2-Position, 24 VAC spring return actuator for ARD, EARD, and ZD dampers
- Low voltage, spring-return damper actuator.
- Equipped with anti-rotation and drive shaft extensions for direct mounting to 7/16 inch diameter coupling style dampers.
- Adjustable range stops.
- Direct replacement for M847D1004



Part #	Mfg #	Description	Price
185746	M847D-ZONE	Replacement Motor for ARD and ZD Dampers	

MSTN Damper Actuator

- Power open/power close damper motor
- Use with MVRV; MVRH; SRTD; IOBD; AOBD-BM; AOBD; ASCD; ARCD



Part #	Mfg #	Description	Price
023257	MSTN	3-Wire 24V Actuator Motor	

Zone Control Accessories

Freeze Protection Control

- Breaks Y circuit to compress below 36°F and remakes it at 46°F
- For use with minizone panels



Part #	Mfg #	Description	Price
023258	FPC	Protects A/C Coil From Freezing Due to Low Air Flow or Excessive Bypass Air	

Fresh Air Ventilators

Y8150 Fresh Air Ventilation System

- "Set it and forget it" program calculates needs based on square feet and number of rooms, etc.
- Operates a fresh air intake damper and when necessary activates the main HVAC blower to efficiently meet ASHRAE ventilation rates
- Includes W8150A fresh air ventilation control, EARD6 normally closed 6" damper, AT120B 120VAC/24VAC 20VA transformer, mounting hardware, homeowner information label
- 5-Year warranty



Part #	Mfg #	Description	Price
179801	Y8150A1017	50 to 160 CFM Fresh Air Ventilation System	

HVAC - General Accessories

Duct Insulation & Adhesives

Duct Liner Insulation Adhesives

Insta-Tack™ Insulation Adhesive

- Instant-tacking, solvent-based spray booth application
- UL Classified



Part #	Mfg #	Size	Color	Price
124942	308591	1 gal	Red	

Insulation



Duct Liner

Duct Liner

Part #	Mfg #	Size	Price
058537		1/2" x 59" x 100'	

Black Duct Liner

Part #	Mfg #	Size	Price
005629	3010031	1/2" x 47" x 100'	
141887	3010033	1/2" x 59" x 100'	
005631	3010005	1" x 47" x 100'	

Insulation

Duct Liner

Mastic Duct Sealants

Duct-Seal™ 321

- Indoor/outdoor use
- Water-based
- All pressure classes
- UL Classified



Part #	Mfg #	Size	Color	Price
094151	DS-321	1 gal	Gray	

Insulation

Duct Wrap

Foil Duct Wrap
Foil Duct Wrap - R4.2

Part #	Size	Price
005622	1-1/2" x 48" x 100'	

Foil Duct Wrap - R6

Part #	Size	Price
131777	2" x 48" x 75'	

Foil Duct Wrap - R8

Part #	Size	Price
094791	3" x 48" x 50'	



Fiberglass Pipe Insulation

Fiberglass Pipe Covering

Part #	Mfg #	Size	Price
005607	3001000	1/2" x 1/2"	
005613	3001001	5/8" x 1/2"	
005611	3001002	3/4" x 1/2"	
005604	3001003	1" x 1/2"	
005606	3001004	1-1/4" x 1/2"	
005605	3001005	1-1/2" x 1/2"	
005608	3001006	2" x 1/2"	
005640	3001110	3" x 1"	

Insulation

Insulation Tape

Insulation Tape

Cork Insulation Tape

- Adheres firmly to all metals
- Can be used on hot and cold pipes
- Won't dry or crack
- Stops condensation and drips



Part #	Mfg #	Description	Price
002287	1006	1/8" x 2" x 30' Roll	

Foam Insulation Tape

- Self-adhesive tape
- Easily cut and molded
- Works on both hot and cold pipes, valves and fittings



Part #	Mfg #	Description	Price
002288	1007	1/8" x 2" x 30' Roll	

Insulation



Insulation Tape

Part #	Mfg #	Description	Price
--------	-------	-------------	-------

Insulation

Insulation Tape

Insulation Accessories
ASJ White Tape for Fiberglass

Part #	Mfg #	Size	Price
087593	3043052	3" x 50 yds	

FSK Tape for Foil Wrap

Part #	Mfg #	Size	Price
010342	3043040	3" x 50 yds	

Insulation

Insulation Tape

Polyken Pipeline Accessory Products

Polyken 826 Joint and Pipe Wrap Tape

- 12 mil Thickness
- Tensile strength: 25 lb/in
- Polyethylene joint and pipe wrap
- Use Polyken primer for surface prep
- Corrosion protection for use interior, exterior and in-ground of small diameter pipe



Part #	Mfg #	Size	Color	Price
010352	826	2" x 100'	Black	

Insulation

Duct Fasteners

Insulation Fasteners

**DynaStick Self-Adhesive Hanger
with Steel Washer**



Part #	Mfg #	Size	Pack	Price
005633	26071	2"	100	

Standard Bangers™



Part #	Mfg #	Size	Pack	Price
005637	BGT-12	1/2" - 2 lbs	1,000	

Insulation

Mechanical Fasteners

Insulation Fasteners

Weld-Ons™



Part #	Mfg #	Size	Qty	Price
132418	308119	1/2" Flat Head	5,000/Box	
132419	308120	3/4" Flat Head	5,000/Box	

R-Foil Insulation

Reflective Insulation

Reflective Duct Insulation

- Double layer of polyethylene bubbles sandwiched between two highly reflective surfaces
- Three methods of installation that will yield thermal resistances of R-4.3, R-5.5 and R-6.0
- Class 1/Class A in accordance with ASTM E84 fire test standard
- Vapor barrier
- Inhibits condensation, mold and fungi growth
- Non-toxic and non-carcinogenic
- Reflects 94% of radiant heat

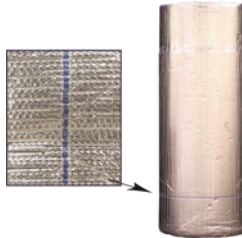

Part #	Mfg #	Description	Price
098392	2290-48-100	48" x 100' Insulation	

Insulation

R-Foil Insulation

Under Concrete Products

Ultra CBF Concrete Barrier

- Patented under-concrete insulation product comprised of a highly reflective sheet sandwiched between two layers of industrial strength polyethylene bubbles
- Protects the reflective surface from corrosive chemicals and ensures that an airspace is maintained for optimum thermal performance
- Can easily be installed over rough grade
- Methane, radiant and vapor barrier all-in-one
- Helps direct radiant heat into the living space
- Duct wrap for below-grade HVAC



Part #	Mfg #	Description	Price
067234	1620-48-125	48" x 125' Concrete Barrier	

Rubber Pipe Insulation

Pipe Insulation

Seamless Rubber Pipe Insulation

- Environmentally friendly
- Tough skin withstands tearing, rough handling and severe environmental conditions
- CFC-Free
- Color: black with blue ink
- Flexible

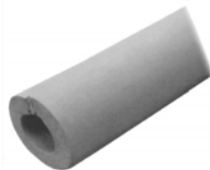

Part #	Mfg #	Copper (IPS/PVC)	Wall	Price
015045	I60-038	3/8" OD	3/8"	
013153	I60-050	1/2" OD (1/4")	3/8"	
015580	I60-058	5/8" OD (3/8")	3/8"	
014724	I60-075	3/4" OD	3/8"	
015774	I60-078	7/8" OD (1/2")	3/8"	
013018	I60-118	1-1/8" OD	3/8"	
013450	I60-138	1-3/8" OD	3/8"	
013631	I60-158	1-5/8" OD (1-1/4")	3/8"	
012476	I60-200	2" OD (1-1/2")	3/8"	
014204	I60-218	2-1/8" OD	3/8"	
013841	I60-250	2-1/2" OD (2")	3/8"	
014278	I60-258	2-5/8" OD	3/8"	
014511	I60-318	3-1/8" OD	3/8"	
014366	I60-350	3-1/2" OD (3")	3/8"	
092086	I61-058	5/8" OD (3/8")	1/2"	
092578	I61-078	7/8" OD	1/2"	
092579	I61-118	1-1/8" OD	1/2"	
126912	I61-158	1-5/8" OD (1-1/4")	1/2"	
143431	I61-218	2-1/8" OD	1/2"	
126909	I61-250	2-1/2" OD (2")	1/2"	
074497	I61-358	3-5/8" OD	1/2"	
122310	I61-450	4-1/2" OD (4")	1/2"	
173788	I62-058	5/8" IPS	3/4"	
173789	I62-075	3/4" IPS	3/4"	
173790	I62-078	7/8" IPS	3/4"	
173791	I62-118	1-1/8" IPS	3/4"	
173792	I62-138	1-3/8" IPS	3/4"	
173793	I62-158	1-5/8" IPS	3/4"	
173795	I62-200	1-1/2" IPS	3/4"	
173796	I62-218	2-1/8" IPS	3/4"	
173797	I62-250	2" IPS	3/4"	
173798	I62-258	2-5/8" IPS	3/4"	
173911	I62-350	3" IPS	3/4"	
227362	I63-058	3/8" IPS	1"	

Double Stick Pipe Insulation

- Complete seal assured on hot or cold water pipes
- (2) Strips of self-adhesive mylar seal easily at any length
- 100% Closed cell polyethylene
- Temperature range: -160° to 200°F



Part #	Mfg #	Size	Wall	Price
015579	I52-058	5/8" Nom ID	3/8"	
015773	I52-078	7/8" Nom ID	3/8"	
013017	I52-118	1-1/8" Nom ID	3/8"	
013449	I52-138	1-3/8" Nom ID	3/8"	
055569	I52-158	1-5/8" Nom ID	3/8"	
101687	I52-178	2" Nom ID	3/8"	
045207	I52-218	2-1/8" Nom ID	3/8"	
142337	I52-238	2-3/8" Nom ID	3/8"	
086331	I52-258	2-5/8" Nom ID	3/8"	
072530	I52-318	3-1/8" Nom ID	3/8"	
191224	I53-078	7/8" Nom ID	1/2"	
063925	I53-312	3-1/2" Nom ID	1/2"	
140583	I53-418	4-1/8" Nom ID	1/2"	
032093	I53-412	4-1/2" Nom ID	1/2"	

Insulation Contact Adhesives

- Fast tack
- Brush top cans
- For use with rubber insulation only



Part #	Mfg #	Size	Price
005643	IA1100	1 Pt	

Insulation

Cleaners

Hand Cleaners

Klein Kleaners® Hand Cleaning Towels

- Pre-moistened towels
- Powerful, gentle, pumice like cleansing action
- No rinsing, no drying, no residue
- 10-1/2" x 12-1/4"



Part #	Mfg #	Description	Price
125643	51425	(72) Count Tub	



Cleaners

(Hand Cleaners)



38156

Part #	Mfg #	Description	Price
041715	38050	Towels-In-A-Tub, Resealable	
017668	38156	Plumb Label Power Scrub	

Cit-Grit Hand Cleaner

- Natural citrus formula, biodegradable
- Contains aloe, lanolin and jojoba oil
- Flip-top spout plastic bottle



Part #	Mfg #	Description	Price
005539	038125	15 fl oz	

Cleaners

Ice Machine Maintenance

Nickel-Safe Ice Machine Cleaner

- For removing scale deposits on nickel-plated or tin-plated evaporators
- USDA Approved



Part #	Mfg #	Description	Price
133631	4287-34	16 fl oz	



Cleaners

Cleaners

Gel-Gloss® Cleaner

- *Contains non-harmful abrasive cleaning agents that remove surface oxidation and light scratches while leaving behind a protective carnauba wax coating*
- *Cleans, protects and restores luster while providing a long lasting protective finish*

Part #	Mfg #	Description	Price
120346	GA-12	12 oz, Aerosol	

Gel-Gloss® No-Streak Glass & Silver Polish Cleaner

- *Contains silicone and protects like a wax*
- *Wipe it on, allow it to dry to a haze and polish it off*
- *Cleaner works aggressively on hard water spots and tough residue*
- *Beads water and leaves behind a protective coating*

Part #	Mfg #	Description	Price
141442	NS-8	1/2 pt	



Lubricants

Pipe Joint Lubricant

Plumber's Faucet & Valve Grease

- *Waterproof*
- *Resists high temperature*
- *Frees sticky faucets, prevents rust*
- *Use on hot water or steam up to 350°F*



Part #	Mfg #	Description	Price
029140	05005012	1 oz Tube	

Lubricants

ProTool Lube®

- *Extends tool life*
- *Synthetic blend for cutting, milling, reaming, tapping and drilling metal, wood and plastics*
- *Water-soluble*
- *Biodegradable and non-toxic*
- *Flip-top bottle*



Part #	Mfg #	Description	Price
024971	68040	6 oz Bottle Countertop Merchandiser, 12-Pack	

Lubricants

Lubricants

Pull-A-Spout Oiler

- All purpose oiler
- 14" Telescoping spout



Part #	Mfg #	Size	Price
002300	CO-1	4 oz	

Rust Breaker

- Loosens rusted bolts, screws, shafts, piping etc
- Telescoping spout applicator



Part #	Mfg #	Size	Price
002299	CR-1	4 oz	



Lubricants

Lubricants

Dow 111 Silicone Lubricant

- For o-rings and valve stems



Part #	Mfg #	Tub Size	Price
060945	963-01	1/4 Ounce	

Lubricants

WD-40® Lubricants

- Cleans, lubricates, displaces moisture
- Penetrates stuck metal parts
- Protects against rust and corrosion



Part #	Mfg #	Size	Price
045103	S95-700	8 oz	

Sumps - Pits & Septic Tanks

Fans for Radon Applications

- 4-1/2" Pipe diameter, 115V
- Improved UV-resistant housings approved for commercial applications
- Sealed housings and wiring boxes to prevent Radon leakage or water penetration
- Energy efficient permanent split capacitor motors
- External wiring box
- UL Approved for wet locations (outdoors)
- Full 5-year factory warranty



HP Series Radon Fans

Part #	Mfg #	Wattage Range	Max Amps	CFM @ 0.75"	Price
113123	HP2133	14 - 20W	0.17A	19	
113124	HP2190	60 - 85W	0.78A	104	

Radon Equipment & Supplies

Radon Pits and Lids

Radon Equipment & Supplies

Radon Sewage Basins

Economy Basin - 18" x 22"

- Constructed of durable, corrosion-resistant polyethylene resin
- Rotationally molded
- Designed for new construction or retrofit applications
- 22 Gallon capacity



Part #	Mfg #	Description	Price
180279	E222001UD	Basin with 4" Inlet Grommet	

Radon Economy Basin - 18" x 22"

- Constructed of durable, corrosion-resistant polyethylene resin
- Includes: gas-tight Ringer grommets
- 22 Gallon capacity



Part #	Mfg #	Description	Price
013695	B22SSR	Basin with Radon Gas-Tight Simplex Steel Cover	

Radon Pits and Lids

Radon Sump Pump Basins

Corrugated Pit and Radon Lid

- Includes:
 - (1) 18" x 24" Pit
 - (1) 18" Radon pit lid (SLR1)

Part #	Mfg #	Description	Price
133074	COMBO RADON	Radon Pit & Lid	

Accessories

GOLDLINE® Radon Safety Locking Lid

- For radon abatement systems
- Child-proof, rugged self-locking lid is drilled for gasketed piping and venting
- Includes gaskets

Part #	Mfg #	Description	Price
133071	SLR1	Radon Safety Locking Lid	

American Standard Repair Parts

Faucet Repair/Replacement Parts

Diaphragm Kit

Part #	Mfg #	Description	Price
001906	72940-0700	Aquaseal Diaphragm f/Heritage (Pr)	

Toilet Repair/Replacement Parts

Flapper

Part #	Mfg #	Description	Price
026083	47146-0070A	Am Std, Rubber Flapper	

Flush Valve

Part #	Mfg #	Description	Price
001827	66287-0070A	Am Std, Cadet Flush Valve Rebuild Kit	

Tank-to-Bowl Kit

Part #	Mfg #	Description	Price
001760	47060-07	Am Std, Tank-to-Bowl Kit	

Toilet Flush Actuator

Part #	Mfg #	Description	Price
001662	33642-0700	Am Std, Toilet Actuating Valve for #5 w/Disc, Chain, Clip & Grommet	

Toilet Installation

Part #	Mfg #	Description	Price
001663	33643-0700	Am Std, Snap-on Seat Disc for 2031.016 Heritage Toilet	

Trip Lever

Part #	Mfg #	Description	Price
001778	47242-0020A	Am Std, Chrome f/Cadet II	
001779	47242-0200A	Am Std, White f/Cadet II	



Basco Repair Parts

Tub & Shower Accessories Self-Adhesive Tape

Part #	Mfg #	Description	Price
048292	SC4248	Self Adhesive Tape	

Vinyl

Part #	Mfg #	Description	Price
048294	SCV284	Tapered Drip Vinyl, 37"	

Repair Parts



Bell & Gossett Repair Parts

Check-Trol™ Isolation Flow Control Flange Sets

- Packaged with an isolation flange of the same size as a pair
- For circulator installations, gives you features of flow control valve, isolation valve and companion flange
- Cap screws and nuts included
- Maximum working pressure: 150 psi
- Maximum operating temperature: 200°F



Flange for NRF/NBF/SSF Wet Rotors (Except NRF-45 & NBF-45),
Series PL-30, PL-36, PL-55, Series 100, PR & LR

Part #	Mfg #	Model	Size	Price
079000	101232	CTF-1	1" NPT x Flange	

Pump Motors and Accessories

Power Pack Motor

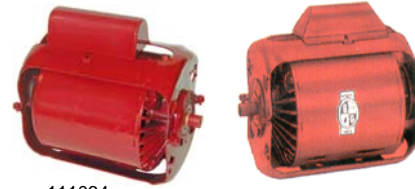

111034

111031

Part #	Mfg #	Phase	Voltage	HP	Price
002433	111034	Single	115V	1/12	
002432	111031	Single	115V	1/6	

Motor Coupler



Part #	Mfg #	Description	Price
002446	118473	For PD-35, PD-37, 60 "AA", 1522 (1/2" Shaft Frame)	
002452	118705	Pump Coupler for Series 100, HV, 2", PR	

Seal Kit

Part #	Mfg #	Description	Price
002457	186862	Seal Kit #1 1-1/4" ID Bronze Fit	

Bearing Assembly



118844

186863

Part #	Mfg #	Description	Price
002455	118844	For 100 Series NFI & BI	
048806	185332	For PD-35, PD-37, 60 "AA"; IB, BF or AB	
002462	189105	For Series PR, 2-1/2", LD-3, HD-3	
002465	189134	Series 100	



Bell & Gossett Repair Parts

Pump Motors and Accessories (Continued) Bearing Assembly

Part #	Mfg #	Description	Price
044637	189163	Obsolete 1-1/2", Obsolete 2", Obsolete HV	
044778	189165	For HV, 2", 1-1/2" Obsolete IB or BI	

Flange Gasket Set



118368

Part #	Mfg #	Description	Price
002442	118373	For 1-1/2", HV and All 1-1/2AA or 1-1/2A Models	
002441	118368	For LR, PL-30, PL-36, Series 100, PR, 60 1AA, 60 11/4AA, PL-55 and All 1AA or 1-1/4AA Models	

Parts & Accessories



Part #	Mfg #	Description	Price
002407	L23401	1.5 oz Oil Tube	

Repair Parts

Bradley Washfountain Repair Parts

Classic Washfountain Parts

Foot Valve Repair Kit

• Includes:

- S21-027 Needle assembly
- S64-006 Valve plunger assembly
- 125-001BW Gasket
- 117-016 Valve seat
- 125-001Y Diaphragm
- 124-001V Fibre washer
- 110-095 Body-needle valve
- 135-001P Spring
- 130-033 Key-valve seat

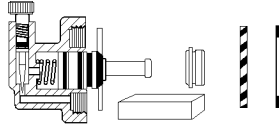

Part #	Mfg #	Description	Price
002730	S65-001A	Foot Valve Repair Kit	

Repair Parts

Chicago Faucet Repair Parts

Handles & Handle Parts



Part #	Mfg #	Description	Finish	Price
002876	369-PRJKCP	(2) 2-3/8" ADA Levers with Hot/Cold Index Buttons	CP	

Faucet Stem & Cartridge



1-099XTJKNF/1-100XTJKNF 377-XTRHJKNF/377-XTLHJK

Part #	Mfg #	Description	Finish	Price
016112	1-099XTJKNF	New Style RH Quatum™ Short Stem Unit for Exposed Valve (12/Box Only)	NF	
056563	1-099XKJKNF	RH Ceramic Short Stem Unit for Exposed Valve (12/Box Only)	NF	
016111	1-100XTJKNF	New Style LH Quatum™ Short Stem Unit for Exposed Valve (12/Box Only)	NF	
056562	1-100XKJKNF	LH Ceramic 1/4-Turn Short Stem Unit for Exposed Valve	NF	
099706	377-XKLHJKNF	LH Ceramic 1/4-Turn Long Stem Unit for Concealed Valve (Sold by box 12/Lot)	NF	
099700	377-XKRHJKNF	RH Ceramic 1/4-Turn Long Stem Unit for Concealed Valve (Sold by box 12/Lot)	NF	
002877	377-XTLHJKNF	LH Quatum™ Long Stem Cartridge for Concealed Valve (Sold by box 12/Lot)	NF	
002878	377-XTRHJKNF	RH Quatum™ Long Stem Cartridge for Concealed Valve	NF	
020910	386-XSLOJKNF	Urinal Push-Button Cartridge	NF	

Pre-Rinse Faucet Components Stainless Steel Hose/Handle Assembly

- Insulated handle
- 3/4"-14 UNS Female outlet, 3/8" MNPT inlet
- T&S & Fisher adapters supplied



Part #	Mfg #	Description	Finish	Price
068698	83-44NF	44" Stainless Steel Hose/Handle Assembly	NF	

Single Water Inlet Fittings Deck-Mount Fitting

- Solid brass body construction
- 5-1/4" Rigid/swing gooseneck spout
- 1/2" NPSM Coupling nut for 3/8" or 1/2" flexible riser
- Mounting hardware included



Part #	Mfg #	Description	Finish	Price
002897	626-E3CP	1-Hole, E3 Softflo Pressure Compensating Aerator	CP	

Repair Parts

Chicago Faucet Repair Parts

Spouts

- Fits 1-1/16"-18 UNEF male body outlet



DJ13JKCP



L8JKCP

Part #	Mfg #	Description	Finish	Price
002797	DJ13JKCP	Double Jointed Swing Spout, 3-7/8"H, 13" Reach, E3 Softflo® Aerator	CP	
002798	DJ18JKCP	Double Jointed Swing Spout, 3-7/8"H, 17-3/4" Reach, E3 Softflo® Aerator	CP	
002811	L8JKCP	L-Type Swing Spout, 4-3/8"H, 8" Reach, E3 Softflo® Aerator	CP	
020853	L9JKCP	L-Type Swing Spout, 6-1/2"H, 9-1/2" Reach, E3 Softflo® Aerator	CP	
002810	L12JKCP	L-Type Swing Spout, 4-5/8"H, 12" Reach, E3 Softflo® Aerator	CP	
002812	S6JKCP	Swing Spout, 1-3/4"H, 6" Reach, E3 Softflo® Aerator	CP	

Gooseneck Spouts

- Available in numerous standard dimensions
- Heavy 1 1/16" OD chrome-plated brass tubing
- Inlet union nut for quick change out
- Allows for field conversion of gooseneck spouts from rigid to swing AND vice-versa

Type A Gooseneck Spout

- Designed to accept Group A spout ends
- Fits 1-1/16"-18 UNEF male body outlet



Part #	Mfg #	Description	Finish	Price
002804	GN1AE3JK	Rigid/Swing GN Spout w/13/16"-24 Male Outlet 8-3/8"H, 3-1/2" Reach	CP	
002805	GN2AE3JKCP	Rigid/Swing GN Spout, 9-3/4"H, 5-1/4" Reach, E3 Softflo® Aerator	CP	
002806	GN8AE3JKCP	Rigid/Swing Spout w/E3 Pressure Compensating Softflo® Aerator 2.2 gpm, 11-1/4"H, 8" Reach	CP	

Outlets & Adapters

- All flow rates up to 80 psi

E3 Pressure Compensating Softflo® Aerator

- Maximum flow rate: 2.2 gpm @ 60 psi
- 13/16"-24 Female inlet



Part #	Mfg #	Description	Finish	Price
002802	E3JKCP	Fits Spouts w/Group A Outlets	CP	

E12 Pressure Compensating Softflo® Aerator

- Maximum flow rate: 2.2 gpm @ 60 psi
- 13/16"-27 Male inlet



Part #	Mfg #	Description	Finish	Price
002799	E12JKCP	For Widespread & Centerset Lavatory Faucet	CP	

Repair Parts

Chicago Faucet Repair Parts

Supply & Shank Connections/Inlets Shanks

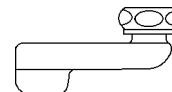

Part #	Mfg #	Description	Finish	Price
020958	HJKCP	2-1/2" Offset Inlet Supply Arm	CP	

Renewing Kits

Quaturn™ & Slow Compression Unit Kit - New Style



Part #	Mfg #	Description	Price
002833	1277D	Jiffy Kit - Box of 12	

Replacement Parts



Part #	Mfg #	Description	Finish	Price
002818	1-006JKNF	Packing (50/Box Only)	NF	
002819	1-011JKNF	Rubber Washer (50/Box Only)		
002822	1-021JKNF	Rubber Seat Washer for X or XT	NF	
002823	1-022JKNF	Retainer for X or XT (100/Box Only)		
002825	1-027JKNF	Seat for X Style (100/Box Only)		
002826	1-031JKNF	Stem Washer for X Style (100/Box Only)		
002827	1-043JKNF	Cap Gasket for X Style (100/Box Only)		
134195	1-104JKNF	Spout Gland		
100595	1104-007JKNF	O-Ring		
144383	122-NF	Thermostatic Mixing Valve	NF	
139530	131-NF	Thermostatic Mixing Valve	NF	
026523	217-XTLHJKNF	LH Slo-Comp (12/Box)	NF	
002847	217-XTRHJK	RH Slo-Comp (12/Box)		
002848	244-006JKNF	Rubber Seat Washer for NAIAD Cartridges	NF	
133595	305-SVBJKCP	Rigid Atmospheric Vacuum Breaker Spout w/3/4" Hose Thread	CP	
028864	333-XSLOPSHJKNF	Pushbutton Unit with Slow-Closing Push Button Cartridge, Push Index & Adj Cycle Time Closure		
138699	420-XJKNF	Ceramic Volume & Temperature Control Cartridge	NF	
033135	671-XJKNF	Metering Valve Unit		
135738	734-CP	Vacuum Breaker Kit		
029908	734-005JKNF	Body Gasket		
134779	892-254KJKCP	Vacuum Breaker Cover & Screw Kit	CP	

Repair Parts

Dearborn Brass Repair Parts

Waste Repair Parts

Repair Part for Bath Waste

- -1 Polished chrome

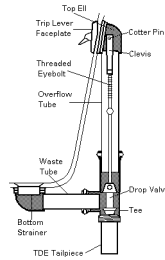

Part #	Mfg #	Description	Price
003327	4503-1	Faceplate, Trip Lever	

Cast Brass Fittings

90° Slip Joint Elbow

- Cast Brass



Part #	Mfg #	Size	Gauge	Price
175072	1675-2	1-1/2"		

Repair Parts

Delta Faucet Repair Parts

Single-Handle Repair Parts Kit

Part #	Mfg #	Description	Price
157966	RP47270SS	Single Lever Handle Kit	
157967	RP47271	Button and Set Screw	
152794	RP52833	Single Metal Lever Handle Kit	
153001	RP60965	Single Lever Handle Kit w/ Button and Set Screw	
131775	RP63138	Single-Handle Repair Parts Kit	

Installation Aids

Quick-Connect Vegetable Spray Nipple Cap

- Converts "with spray" to "less spray"

Part #	Mfg #	Description	Price
074978	RP40301	Quick Connect Coupling, Vegetable Spray Cap	
181058	RP70613	Set Screw & Wrench	

Quick-Connect Hose

- For installing handle and spout farther apart

Part #	Mfg #	Description	Price
144185	RP50390	Hose Assembly & Clip	

Lavatory Drains

Metal Lavatory Drain Assembly

- Metal pop-up drain
- Metal lift-rod



Part #	Mfg #	Description	Price
003641	RP5651	Chrome	
003643	RP5651PB	Polished Brass*	
093335	RP5651RB	Venetian Bronze®	
103471	RP5651SS	Stainless*	

Lavatory Drain Stopper



Part #	Mfg #	Description	Price
003637	RP5648	Chrome	
168193	RP5648CZ	Champagne Bronze™	
168478	RP5648NK	Luxe Nickel*	
159075	RP5648RB	Venetian Bronze®	
158887	RP5648SS	Stainless*	

RP51732 Lift Rod Assembly



Part #	Mfg #	Description	Price
167091	RP51732SS	Stainless*	

RP41588 Lift Rod



Part #	Mfg #	Description	Price
164015	RP41588	Chrome	

RP40267 Lift Rod

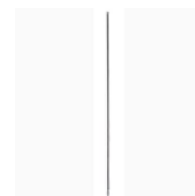

Part #	Mfg #	Description	Price
171467	RP40267	Chrome	

RP54095 Lift Rod and Finial

Part #	Mfg #	Description	Price
168032	RP26151	Chrome	
187287	RP51291	Chrome	
157901	RP54095RB	Venetian Bronze®	
153597	RP61992	Chrome	

Final - Lavatory Lift Rod Top



Part #	Mfg #	Description	Price
171468	RP41574	Chrome	
173135	RP41574SS	Stainless*	

* Brilliance® Anti-Tarnish Lifetime Finishes

www.plumbsupply.com • Serving our Customers Since 1946 • www.waterconcepts.net

Delta Faucet Repair Parts

Lavatory Drain Flange



Part #	Mfg #	Description	Price
168192	RP23060CZ	Champagne Bronze™	
149920	RP23060SS	Stainless*	

Conversion Ball

- Converts knob to lever handle
- Makes faucet ADA compliant



Part #	Mfg #	Description	Price
003587	RP20111	Conversion Ball	

Bath Installation Aids

Delta® Extension Kits

- Adds 1" to shanks



Part #	Mfg #	Description	Price
051857	RP10612	For 3530/3540/3543/3544/ 3555/3665/3567/3569/ 3577/3578/3583	

TempAssure® 17T Series Extension Kit

- Additional 1-3/4" installation



Part #	Mfg #	Description	Price
183263	RP75136	Extension Kit - 17T Series	

3 And 6-Setting Diverter Extension Kit



Part #	Mfg #	Description	Price
157035	RP75137	Extension Kit - Diverter	

Delta® Horizontal Rod



Part #	Mfg #	Description	Price
003436	RP12517	Chrome	

6-Setting Diverter Cartridge



Part #	Mfg #	Description	Price
135236	RP51919	Diverter Cartridge	

3-Setting Non-Shared Diverter Cartridge



Part #	Mfg #	Description	Price
163268	RP71718	Diverter Cartridge	

2-Hdi DIAMOND™ Valve Assembly



Part #	Mfg #	Description	Price
148058	RP60400	Valve Assy	

Euro-Motion™ Valve Assembly



Part #	Mfg #	Description	Price
153040	RP60114	Valve Assy	

* Brilliance® Anti-Tarnish Lifetime Finishes

www.waterconcepts.net • Serving our Customers Since 1946 • www.plumbsupply.com

Delta Faucet Repair Parts

Euro-Motion™ Ceramic Valve



Part #	Mfg #	Description	Price
187321	RP75402	Ceramic Valve	

Multi-Choice® Universal Cartridge Assembly -13/14 Series

- Monitor® single-function pressure-balance cartridge
- Rotational limit stop easily adjusts via lift and turn
- For MultiChoice® universal 13/14 series tub and showers



Part #	Mfg #	Description	Price
095758	RP46074	Cartridge Assy	

Multi-Choice® Universal Cartridge Assembly -17 Series

- Monitor® dual-function pressure- balance control
- For MultiChoice® 17 series tub and showers
- Allows for separate volume and temperature control



Part #	Mfg #	Description	Price
102530	RP46463	Cartridge Assy	

Multi-Choice® Universal Cartridge Assembly -17T Series

- TempAssure® dual-function thermostatic cartridge
- For Multi-Choice® 17T series trim
- Allows for separate volume and temperature control



Part #	Mfg #	Description	Price
115704	RP47201	Cartridge Assy	

Diverter Assembly



Part #	Mfg #	Description	Price
003529	RP17730	Diverter Assembly	
035054	RP19653	Diverter Assembly	

* Brilliance® Anti-Tarnish Lifetime Finishes

www.plumbsupply.com • Serving our Customers Since 1946 • www.waterconcepts.net

Stem Cartridge Kit - (2)



Part #	Mfg #	Description	Price
170775	RP41701	Stem Cartridge Kit	

Two Handle Ceramic Stem Cartridge - (Pair)



Part #	Mfg #	Description	Price
167855	RP47422	Stem Cartridge - Pair	

Stem Unit Assembly

- Includes:
 - Seat
 - Spring
 - Bonnet Nut
 - Washer



Part #	Mfg #	Description	Price
171576	RP54801	Stem Unit Assy	

Metering Valve



Part #	Mfg #	Description	Price
166640	RP72773	Metering Valve	

Valve Cartridge



Part #	Mfg #	Description	Price
164727	RP50265	Valve Cartridge	

Repair Parts

Delta Faucet Repair Parts

Non-Shared Diverter Cartridge



Part #	Mfg #	Description	Price
166480	RP71717	2-Function Non-Shared Diverter Cartridge	

Cartridge Fluehs



Part #	Mfg #	Description	Price
155280	RP61824	Cartridge Fluehs - Cold	
154243	RP61825	Cartridge Fluehs - Hot	

Cer-Tek Cartridge

- RH

Part #	Mfg #	Description	Price
130298	063000A	RH Cer-Tek Cartridge	
130299	063001A	LH Cer-Tek Cartridge	

Thin Wall Installation Aid

- For MultiChoice® universal thin mount installation aid



Part #	Mfg #	Description	Price
094435	RP47202	Thin Mount Aid	

Shower Renovation Cover Plate

- Covers up 8" center holes



Part #	Mfg #	Finish	Price
040814	RP29827	Chrome	
130864	RP29827RB	Venetian Bronze®	
134118	RP29827SS	Stainless*	

Deep Escutcheon



Part #	Mfg #	Description	Price
222353	RP21633SS	Stainless*	

600 Series Escutcheon - Shallow



Part #	Mfg #	Description	Price
040905	RP6083	Chrome	

600 Series Tub and Shower Renovation Kit

- Includes:

- RP17443RB - Lever handle
- RP5883RB - Escutcheon
- RP1050RB - Cap
- RP5893RB - Sleeve
- RP196RB - Escutcheon screws
- RP20111 - Conversion ball
- RP4993 - Seats and springs
- RP188 = Cam and packing

- Order RP2865 plug for push button diverter
- Diverter tub spout may be required



Part #	Mfg #	Finish	Price
132394	RP54870	Chrome	
132395	RP54870RB	Venetian Bronze®	
129199	RP54870SS	Stainless*	

1900 Conversion Trim Kit



Part #	Mfg #	Description	Price
164080	RP54316	Chrome	
171340	RP54318	Chrome	
167369	RP54318RB	Venetian Bronze*	

* Brilliance® Anti-Tarnish Lifetime Finishes

www.waterconcepts.net • Serving our Customers Since 1946 • www.plumbsupply.com

Delta Faucet Repair Parts

6-Setting Diverter Escutcheon

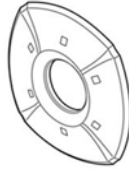

Part #	Mfg #	Description	Price
154615	RP61658SS	Stainless*	

Dryden™ 6-Setting Diverter Escutcheon

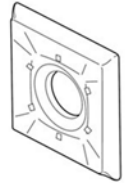

Part #	Mfg #	Description	Price
154795	RP52594RB	Venetian Bronze®	

Deep Escutcheon with Push Button Diverter



Part #	Mfg #	Description	Price
162814	RP21634	Escutcheon, Chrome	

6-Setting Diverter Escutcheon



Part #	Mfg #	Description	Price
179525	RP42413RB	Venetian Bronze®	

Escutcheon

- Diagonal escape screw holes



Part #	Mfg #	Description	Price
032826	RP19809	Chrome	
157469	RP19809SS	Stainless*	

Escutcheon - 14 Series



Part #	Mfg #	Description	Price
154524	RP48716	Chrome	

Escutcheon - Shallow



Part #	Mfg #	Description	Price
043944	RP7577	Chrome	

Escutcheon/Seal - 14 Series

Part #	Mfg #	Description	Price
167604	RP75436	Chrome	

Escutcheon Trim Screws

- Set of 2



Part #	Mfg #	Description	Price
087663	RP196SS	Stainless*	

Tub & Shower Escutcheon

- Square



Part #	Mfg #	Description	Price
154796	RP52583RB	Venetian Bronze®	

Jetted Shower XO® Stem Extender

Part #	Mfg #	Description	Price
135242	RP37902	Stem Extender	
100606	RP37903	Stem Extender	

* Brilliance® Anti-Tarnish Lifetime Finishes

www.plumbsupply.com • Serving our Customers Since 1946 • www.waterconcepts.net

Repair Parts

Delta Faucet Repair Parts

Handshower Assembly



Part #	Mfg #	Description	Price
159519	RP52589SS	Stainless*	

Kitchen Spray Assemblies

Victorian® Spray and Hose Assembly

- To be used for DIAMOND™ seal technology models



Part #	Mfg #	Description	Price
164086	RP37489SS	Stainless*	

Classic Spray & Hose Assembly

- To be used for non-DIAMOND™ seal technology models



Part #	Mfg #	Description	Price
074675	RP39360	White	

Signature® Waterfall® Spray & Hose Assembly

- To be used for non-DIAMOND™ seal technology models
- Includes nest



Part #	Mfg #	Finish	Price
098546	RP39345	Chrome	
091323	RP39345SS	Stainless*	

Pilar® Linden™ Spray, Hose and Diverter Assembly

- To be used for DIAMOND™ seal technology models
- Touch-Clean® spray holes
- Front trigger control
- Finished spray face



Part #	Mfg #	Description	Price
185590	RP53880	Chrome	
165648	RP53880AR	Arctic Stainless	

Kitchen Spray Assemblies (Continued)

Pilar® Linden™ Spray, Hose and Diverter Assembly

Part #	Mfg #	Description	Price
156781	RP53880RB	Venetian Bronze®	

Victorian® Spray, Hose, and Diverter Assembly

- To be used for DIAMOND™ seal technology models



Part #	Mfg #	Description	Price
170824	RP53881RB	Venetian Bronze®	

Collins™ Spray, Hose and Diverter Assembly

- To be used for DIAMOND™ seal technology models
- Touch-Clean® spray holes
- Finished spray face



Part #	Mfg #	Description	Price
130164	RP54235	Chrome	
144787	RP54235SS	Stainless*	

Cassidy™ Spray and Hose Assembly

- Touch-Clean® spray holes
- Front trigger control
- Finished spray face



Part #	Mfg #	Description	Price
167693	RP72751	Chrome	

Spray and Hose Assembly



Part #	Mfg #	Description	Price
179527	RP61013RB	Venetian Bronze*	

* Brilliance® Anti-Tarnish Lifetime Finishes

www.waterconcepts.net • Serving our Customers Since 1946 • www.plumbsupply.com

Delta Faucet Repair Parts

Classic and Signature® Spray & Hose Assembly

- To be used for single handle non-DIAMOND™ seal technology models
- Finished sprayer



Part #	Mfg #	Finish	Price
044116	RP31612	Chrome	

Spray & Hose Assembly



Part #	Mfg #	Finish	Price
058833	RP28900	Chrome	
059165	RP28900SS	Stainless*	
168533	RP32250BN	Brushed Nickel*	

Kitchen Spray Assembly



Part #	Mfg #	Description	Price
224779	RP43524SS	Stainless*	

Classic Spray, Hose and Diverter Assembly

- To be used for DIAMOND™ seal technology models



Part #	Mfg #	Finish	Price
134487	RP60097	Chrome	
180881	RP60097SS	Stainless*	

Foundations® Spray, Hose Assembly and Spray Support

- Lead free
- For single handle kitchen models



Part #	Mfg #	Description	Price
145981	RP54807	Chrome	
187325	RP54807SS	Stainless*	

Spray Support Assembly



Part #	Mfg #	Description	Price
003664	RP6015	Chrome	

Quick-Connect Vegetable Spray Hose



Part #	Mfg #	Description	Price
103219	RP37034GR	White	

Pull-Out Wand Assembly



Part #	Mfg #	Description	Price
154289	RP53102AR	Arctic Stainless™	
147391	RP53102SS	Stainless*	

Pull-Down Wand Assembly



Part #	Mfg #	Description	Price
160975	RP72680AR	Pull-Down Wand Assembly	

Wand Assembly



Part #	Mfg #	Description	Price
182191	RP51480	Chrome	
156754	RP51480RB	Venetian Bronze®	
152052	RP51480SS	Stainless*	

* Brilliance® Anti-Tarnish Lifetime Finishes

www.plumbsupply.com • Serving our Customers Since 1946 • www.waterconcepts.net

Repair Parts

Delta Faucet Repair Parts

Spray Assembly



Part #	Mfg #	Description	Price
181927	RP46751SS	Stainless*	

Palo Wand Assembly



Part #	Mfg #	Description	Price
117444	RP44643	Chrome	
168840	RP44643SS	Stainless*	

Pull-Down Spray Assembly

- Includes aerator



Part #	Mfg #	Description	Price
159024	RP47269SS	Stainless*	

RP44477 Pull-Out Wand Assembly



Part #	Mfg #	Description	Price
168481	RP44477SS	Stainless*	

Fuse Pull-Down Wand Assembly

Part #	Mfg #	Description	Price
175890	RP70703SB	Stainless*/Cracked Pepper	

Soap/Lotion Dispenser Accessories

Soap/Lotion Dispenser Nut

Part #	Mfg #	Description	Price
037864	RP21945	Dispenser Nut	

Sprayer Wand Assembly

- Pull-out faucets



Soap/Lotion Dispenser Body Assembly



Part #	Mfg #	Description	Price
152076	RP53438SS	Stainless*	

Part #	Mfg #	Description	Price
187739	RP21906SS	Stainless*	

Wand Assembly with Hose

- Pull-out faucets



Soap/Lotion Dispenser Pump Head



Part #	Mfg #	Description	Price
063196	RP32542	Chrome	
161322	RP32542AR	Arctic Stainless™	
162140	RP32542BL	Matte Black	

Part #	Mfg #	Description	Price
160946	RP21905SS	Stainless*	

* Brilliance® Anti-Tarnish Lifetime Finishes

www.waterconcepts.net • Serving our Customers Since 1946 • www.plumbsupply.com

Delta Faucet Repair Parts

Kitchen Accessories

Sliding Weight

- For use with Pull-Down/Out kitchen faucets



Part #	Mfg #	Description	Price
188349	RP49149	N/A	

Kitchen Diverter Assembly

- Diverter assembly kit 1-handle Delta® replacement

Part #	Mfg #	Description	Price
133121	RP63135	Kitchen Faucet Diverter Assembly	
136138	RP63135MBS	Diverter Assembly	
132777	RP63136	1-Handle Diverter Assembly	
133157	RP63136MBS	Kitchen Diverter Assembly	

8" Escutcheon



Part #	Mfg #	Description	Price
149596	RP64070	Chrome	
146679	RP64070AR	Arctic Stainless™	
162388	RP64070CZ	Champagne Bronze™	

Escutcheon, Base, and Gasket



Part #	Mfg #	Description	Price
148562	RP64472AR	Arctic Stainless™	
168129	RP64472SS	Stainless*	

Square Escutcheon



Part #	Mfg #	Description	Price
153685	RP63970RB	Venetian Bronze®	
143753	RP63970SS	Stainless*	

Escutcheon - 3 Hole



Part #	Mfg #	Description	Price
170028	RP44645SS	Stainless*	

10" Escutcheon



Part #	Mfg #	Description	Price
158527	RP47274AR	Arctic Stainless™	
158533	RP47274RB	Venetian Bronze®	

Escutcheon, Gasket (3-Hole)



Part #	Mfg #	Description	Price
225247	RP72991SS	Stainless*	

Decorative Escutcheon

- 10" Long



Part #	Mfg #	Description	Price
158526	RP71545	Chrome	
154412	RP71545AR	Arctic Stainless™	
158563	RP71545CZ	Champagne Bronze™	

* Brilliance® Anti-Tarnish Lifetime Finishes

www.plumbsupply.com • Serving our Customers Since 1946 • www.waterconcepts.net

Delta Faucet Repair Parts

Kitchen Accessories (Continued)

Decorative Escutcheon

Part #	Mfg #	Description	Price
153577	RP71545RB	Venetian Bronze®	

Shallow Escutcheon

- Pressure balance diverter off indicator

Part #	Mfg #	Description	Price
076614	RP6107	Chrome	

Handle Base

- Square handle bases
- Sold in pairs
- Includes flange support, gasket and set screw



Part #	Mfg #	Description	Price
157758	RP52659SS	Stainless*	

Flow Control for Gooseneck Spout

Part #	Mfg #	Description	Price
170888	060873A	Flow Control	

Mounting Hardware



Part #	Mfg #	Description	Price
186978	RP52609	Mounting Hardware	

Pilar® Check Valves



Part #	Mfg #	Description	Price
138069	RP53468	Pilar® Check Valves	

Shower Parts

Single Lever Handle Kit - 17T Series



Part #	Mfg #	Description	Price
153179	RP51309SS	Stainless*	

17 Series Handle Assembly - Temp



Part #	Mfg #	Description	Price
184230	RP70641	Chrome	

13/14 Series Handle Assembly



Part #	Mfg #	Description	Price
132336	RP48717	Chrome	

Handle Assembly



Part #	Mfg #	Description	Price
164895	RP73643	Chrome	
186959	RP72685RB	Venetian Bronze®	

Temperature Dial



Part #	Mfg #	Description	Price
163903	RP73642	Chrome	

* Brilliance® Anti-Tarnish Lifetime Finishes

www.waterconcepts.net • Serving our Customers Since 1946 • www.plumbsupply.com

Delta Faucet Repair Parts

Trim Sleeve - Tub & Shower



- Clip only
- Quick-connect

Part #	Mfg #	Description	Price
157460	RP50879RB	Venetian Bronze®	
166988	RP50879SS	Stainless*	

Hose Clip



Part #	Mfg #	Description	Price
144186	RP60911	Hose Clip	

Trim Sleeve - 17 and 18 Series



Part #	Mfg #	Description	Price
151398	RP50880RB	Venetian Bronze®	
151435	RP50880SS	Stainless*	

Valve Sleeve Assembly



Part #	Mfg #	Description	Price
172344	RP51481RB	Venetian Bronze®	

Trim Sleeve - Tub & Shower



Part #	Mfg #	Description	Price
031006	RP5893	Chrome	

Bar Slide Knob



Part #	Mfg #	Description	Price
175920	4116BX	For Models 55024 & 55030, Clear	

Trim Sleeve - 13 and 14 Series



Part #	Mfg #	Description	Price
172685	RP22735SS	Stainless*	
096706	RP39407	14 Series Only, Chrome	

Bath Waste Parts

Bath Waste Assembly

- Toe-operated
- 13-1/2" Max vertical adjustment
- 7-3/4" max horizontal adjustment
- Brass construction



Part #	Mfg #	Description	Price
177578	RP293	Chrome	

Copper Plug - Shower Only



Part #	Mfg #	Description	Price
021656	RP20032	Copper	

* Brilliance® Anti-Tarnish Lifetime Finishes

www.plumbsupply.com • Serving our Customers Since 1946 • www.waterconcepts.net

Delta Faucet Repair Parts

Tub Drain

- Toe-operated
- Stopper and waste plug
- Stopper screw threads are 5/16"-18



Part #	Mfg #	Description	Price
159165	RP31558CZ	Champagne Bronze™	

Overflow Plate Assembly

- Trip lever



Part #	Mfg #	Description	Price
078455	RP6403RB	Venetian Bronze®	

Waste Plug

- Toe operated
- 1-1/2"-11-1/2" NPSM



Part #	Mfg #	Description	Price
166059	RP16687	Chrome	

Bonnet Cap

- With adjusting ring



Part #	Mfg #	Finish	Price
003631	RP50	Chrome	

Stopper Assembly

- Toe operated
- 5/16" - 18" thread size



Part #	Mfg #	Description	Price
177577	RP16686PN	Polished Nickel	

Mini-Bulk Parts

Aerator

- 15/16" - 27 Male thread
- For most kitchen and lavatory faucets
- 2.2 gpm @ 60 psi



Part #	Mfg #	Description	Price
022154	RP330MBS	Chrome, 60 Per Case	

Cam and Packing-Knob

- For single knob handle faucets



Part #	Mfg #	Description	Price
003552	RP188	For Single Knob Handle	
017861	RP188MBS	64 Per Case	

Cam & Packing - Lever

- For single lever handle faucets



Part #	Mfg #	Description	Price
017522	RP61MBS	64 Per Case	

Seat

- For all 1-handle and 2-handle faucets



Part #	Mfg #	Description	Price
022156	RP1806MBS	240 Per Case	

Spring

- For all 1-handle and 2-handle faucets



Part #	Mfg #	Description	Price
022158	RP3427MBS	240 Per Case	

Seats, Springs, Quad Rings

- Qty. 2



Part #	Mfg #	Description	Price
063896	RP28603	Seats, Springs, Quad Rings	

* Brilliance® Anti-Tarnish Lifetime Finishes

www.waterconcepts.net • Serving our Customers Since 1946 • www.plumbsupply.com

Delta Faucet Repair Parts

Seats & Springs Boxed Assortment Kit



Part #	Mfg #	Description	Price
003740	RP4039	Seats & Springs 24-RP4993	

Ceramic Seats and Seals

- Qty. 2



Part #	Mfg #	Description	Price
020357	RP10700	Ceramic Seats and Seals	

Stainless Steel Ball - Knob

- For single knob handle faucets except 1300, 1400 & 1600 tub/shower series and pull-out spray models



Part #	Mfg #	Description	Price
022152	RP212MBS	60 Per Case	

Stainless Steel Ball - Lever

- For single lever handle faucets except 1300, 1400, 1500, 1600, 1700 & 1800 T/S series and pull-out spray models



Part #	Mfg #	Description	Price
022151	RP70MBS	60 Per Case	

Stem Unit & Seat

- For 1600 tub/shower series

Part #	Mfg #	Description	Price
003582	RP1991	Stem Unit & Seat	
022157	RP1991MBS	Stem Unit & Seat, 12 Per Case	

Stem Unit with Stainless Steel Plate

- For 2-handle and basin faucets



Part #	Mfg #	Description	Price
003515	RP1740	Stem Unit Assy	
022155	RP1740MBS	Stem Unit Assy, 60 Per Case	

Delta® Plumber's Box of Parts



Part #	Mfg #	Description	Price
134141	RP63139	Plumber's Box of Parts	

Delta® Repair Kits/Parts

Ball Assemblies

Part #	Mfg #	Description	Price
003724	RP70	For 1-H Lever	
003592	RP212	For 1-H Knob	

O-Rings

Part #	Mfg #	Description	Price
114466	RP13938	O-Ring	
154097	RP18362	O-Ring	
003605	RP25	1-Hdl Kit Spout	
003589	RP2055	For 2-H Kitchen Spout	
019817	RP21535	For 462/466	
040285	RP22934	For 2-H Waterfall® Kitchen Deck	
061918	RP32520	Spout O-Rings for 470 & 472	
178227	RP50388	O-Ring	
170777	RP73984	Clip and O-Ring	
071330	RP14414	13/14 Series Qty. 2	
003585	RP20049	O-Ring	

Repair Parts

* Brilliance® Anti-Tarnish Lifetime Finishes

www.plumbsupply.com • Serving our Customers Since 1946 • www.waterconcepts.net

Delta Faucet Repair Parts

O-Ring

- For 100/200/300/400 single-handle kitchen deck faucets manufactured since 1969 models



Part #	Mfg #	Description	Price
022150	RP25MBS	120 Per Case	

Screws

Part #	Mfg #	Description	Price
003437	RP12630	Escutcheon Trim Screws, Extra Long	
155211	RP12630RB	Escutcheon Trim Screws, Extra Long - Ven Bronze®	
003496	RP152	For Single Lever Handle	
003564	RP196	Chrome	
033496	RP25620	Set Screws for Small Handle Bases	
032801	RP26865	Set Screws for Large Handle Bases	
168960	RP40650	Set Screw	
157647	RP54170B	Escutcheon Screws (2)	
158261	RP61819	On Wall Screws 4 Lengths	

Delta® Repair Parts

Part #	Mfg #	Description	Price
111465	060683A	Hard Wire Converter	
188507	063093A	R3 Spout for 54T2402	
144039	060602A	Sngl Blade Hdl w/ Screw	
217207	4124CBG	Cap - GL Rail BG	
028507	4959BG	Rubber Gaskets - Bag of 5	
177587	EP73954	AP Power Supply	
178564	EP74852	Solenoid Assembly	
183919	EP74854	Solenoid Assembly	
109632	RP1050	Bonnet Nut	
188994	RP11768HDF	Commercial Lever Handles, Brass w/ Screws	
026356	RP12629	Screw Set	
099577	RP16213	Screwdriver Stop Assembly	
003512	RP16423	Reverse Ball	
019240	RP18090	Escutcheon	
025093	RP18276	Chrome Escutcheon	
025092	RP18136	Sleeve, Chrome	
003591	RP2090	Check Stop Stem Assembly	
029096	RP21463	Retainer - Spout	
033619	RP21469	1Hdl Lever Kit with Screw	

Delta® Repair Parts (Continued)

Part #	Mfg #	Description	Price
154634	RP21469SS	1Hdl Lever Kit with Screw	
086213	RP23094SS	Handle Base w/ Gasket	
003597	RP2389	Clear 1-Handle Lavatory w/Button & Screw	
003601	RP2393	1 Kitchen Lever Handle w/Set Screw	
003603	RP2411	Button, Clear	
003608	RP250	Adjusting Ring	
031329	RP250MBS	Adjusting Ring	
165820	RP26758	Screw On Sleeve	
044850	RP28595	Temp Knob and Cover	
054794	RP29569	Spacer	
059633	RP33805	10-1/8" Horizontal Rod	
003623	RP3614	Lever Repair Kit	
155976	RP37022SS	Bonnet, Washer and Clip	
161873	RP42168SS	Body Spray Escutcheon	
171342	RP42208	Wrench	
168961	RP46748SS	1-Hdl with Button and Screw	
164132	RP47030	Lavatory Wrench	
003630	RP4993	Deluxe Seats & Springs (2)	
122686	RP50366	Stem Assembly w/ O-Rings and Nuts	
144187	RP51503	Bonnet Nut	
132784	RP52834	Single Metal Lever Handle Kit	
131263	RP53997	Diverter Clip	
003639	RP5649	Diverter Assembly, Chrome	
003649	RP574	Balance Spool Assembly	
003657	RP5861	Coupling Nuts	
003662	RP6011	Hose & Spray, Black/CP	
003678	RP6060	Nut	
037831	RP6079	Bonnet, Chrome	
040904	RP6081	Sleeve, Chrome	
003687	RP6092	Nuts & Washers	
003695	RP6130	Pivot Seat & Gasket	
153121	RP61820	Stem Assembly	
003705	RP6183	Locknuts	
151297	RP64696	Spout Assembly - Locked	
003734	RP8230	Ceramic Stem, Seat, O-Ring, Spring	
003434	RP12491	(2) HDF Wrist Blade Handles w/Set Screw	
024497	RP12490	Screws - Red and Blue	
003520	RP17449	Clear Handle w/Button & Screw, for Single Handle Faucet	

* Brilliance® Anti-Tarnish Lifetime Finishes

www.waterconcepts.net • Serving our Customers Since 1946 • www.plumbsupply.com



Delta Faucet Repair Parts

Delta® Repair Parts (Continued)

Part #	Mfg #	Description	Price
023197	RP17451	Clear Handle w/Button & Screw, for Tub & Shower	
024762	RP18627	Extender less Screws	
003568	RP19659	Button	
003572	RP19804	Cartridge Assembly	
022311	RP19807	Limit Stop	
049620	RP22734	Plated Bonnet	
187688	RP23094CZ	Handle Base & Gasket	
030260	RP23498	Clear Knob Handle w/Screws	
185875	RP23611RB	Base with Gasket	
024314	RP24096	Brass Stem Assy	
003604	RP2412	Two Handle Blade (2)	
050183	RP25513	Stem Unit w/Brass Stem	
137175	RP2865	Plug Push Button Diverter	
179884	RP30532	Battery Holder	
045840	RP32104	1700 Cartridge	
067930	RP32105	1700 Handle Screw	
048950	RP32522	Quick-Connect Clip	
151759	RP36203	Ext Nut and Washer for Electronic Fct	
187883	RP38367	End Valve Assembly	
184164	RP41702	2Hdl Kitchen Diverter	
181968	RP38644RB	Escutcheon and Gasket	
140695	RP40668	R4700 Diverter Valve Assembly	
101730	RP41478	Nut and Adapter	
174179	RP44118BN	Handle Kit, Brushed Nickel	
161938	RP44118OB	Handle Kit, Oil-Rubbed Brz	
172682	RP44123	Repair Kit	
184827	RP44493	Hose Assembly	
107694	RP44647	Pull-Out Hose Assembly	
144594	RP46079	Pressure Test Hot/Cold Plug	
186204	RP47029	Lavatory Mounting Bracket	
157015	RP48592	Single Lever Handle Kit	
169900	RP49835	Mounting Nut	
169899	RP50391	Gasket and Baseplate	
107655	RP51099	7' Leader Hose for Roman Tub	
160483	RP51290SS	Roman Tub Hand Shower Base Escutcheon	
223508	RP51306RB	17 Series Handle Kit	
187868	RP51306SS	17 Series Handle Kit	
151859	RP51307	1-Hdl Lever Handle Kit	
223509	RP51307RB	17 Series Handle Kit	
187869	RP51307SS	17 Series Handle Kit	

Delta® Repair Parts (Continued)

Part #	Mfg #	Description	Price
161418	RP51345	Aerator - 1.5 GPM	
187690	RP51424	Temperature Knob and Cover	
160738	RP51479RB	Valve Sleeve Assembly	
222638	RP51502AR	Bonnet Cap	
173807	RP51514SS	Sleeve Assembly	
157876	RP51628RB	Escutcheon & Gasket	
154211	RP51685	Mounting Bracket and Nut	
179559	RP52147SS	Temp Knob and Cover	
164030	RP53879	Handle Button	
166762	RP53879SS	Handle Button, Stainless*	
131262	RP54269	Spray Cap	
157044	RP54974	Hot/Cold Indicator	
137154	RP60923	Kitchen Repair Part	
135054	RP43233	D-Spacer 14 Series	
155781	RP50389	Escutcheon and Gasket	
122117	RP50587	Single Handle Valve Cartridge	
161889	RP51490	Escutcheon - Single Handle Kitchen Faucet	
154210	RP52610	Trim Ring, Base & Gasket	
164131	RP53217	Mounting Hardware - Valve	
176568	RP53531	Mounting Nuts	
173987	RP54232	Handle Kit, Chrome	
181486	RP54232SS	Handle Kit, Stainless	
166331	RP54687	Single Lever Elbow Handle	
153810	RP60962	Escutcheon and Gasket	
177033	RP60979	Trim Ring, Base and Gasket	
003688	RP61	Cam Assembly - Lever	
158729	RP6148	Escutcheon	
177305	RP61839RB	Escutcheon - Single Hole	
151718	RP6185	Stop Stem Assembly	
155272	RP62094SS	Handle Base w/ Gasket	
177217	RP62150SS	Handle Kit	
171385	RP62961	Bidet Base, Chrome	
164948	RP62961SS	Bidet Base, Stainless	
154459	RP63131	Spout Assembly	
175400	RP63265	1/2" Slip Joint Adapter	
187192	RP64150SS	Mounting Post	
187191	RP64152SS	Slide Mechanism	
158670	RP64706	Handle Kit - 2-Hdl	
158671	RP64760	Stem Unit Assembly	
173247	RP64851	Diverter Bonnet Nut	
181639	RP70635RB	Roman Tub 2-Hdl Handle Kit	

* Brilliance® Anti-Tarnish Lifetime Finishes

www.plumbsupply.com • Serving our Customers Since 1946 • www.waterconcepts.net



Delta Faucet Repair Parts

Delta® Repair Parts (Continued)

Part #	Mfg #	Description	Price
181640	RP70637RB	Handle Flange, Ven Brz	
185771	RP70638RB	Diverter Lift Rod	
168736	RP70639RB	Shower Handle Assembly, Ven Bronze	
178178	RP72289	Lift Rod Plug	
185650	RP72721SS	Handshower Base	
180482	RP73054	Gaskets	
155687	RP73192	Red/Blue Button	
168272	RP73837	Low Flow Regulator	
177576	RP7424PN	Overflow Plate	
156883	RP7424RB	Overflow Plate	
181717	RP74608	54" PO Hose (Small OD)	
181034	RP74812	O-Rings	
173787	RP75408	Rectangular Aerator, Set Screw	
187322	RP75409	Flow Regulator	
170776	RP76691	Centerset Extension Kit	
185305	RP77162	Escutcheon	
186205	RP77263SS	Escutcheon - 3 Hole	
186203	RP77457SS	Button - Lift Rod Hole Cover	
166060	RP7900	Gasket	
225577	RP81914	Mateo® Escutcheon	
186097	RP83888	Valve Bracket	

Repair Parts

* Brilliance® Anti-Tarnish Lifetime Finishes

www.waterconcepts.net • Serving our Customers Since 1946 • www.plumbsupply.com

Elkay Repair Parts

Elkay Sink Parts & Accessories
Mounting Clip



Part #	Mfg #	Description	Price
006122	LK-363	Long Sink Clips	
104709	LK-463	Elkay Sink Clips for 1-5/8", 2", 2-1/2" Thick Tops	
162112	LKUCLIP8	Mounting Clip for Undermount Sinks	

Replacement Part

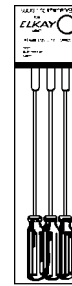

Part #	Mfg #	Description	Price
006120	LK-350	Socket Screwdriver	

Repair Parts

Elkay Repair Parts



35981-C



50986-C

Water Cooler Parts



55996-C



61313-C



61314-C

Part #	Mfg #	Description	Price
023576	31513C	Elkay Cold Control	
086622	35981C	Elkay 1/4 Solenoid Valve	
022839	50985C	Holder Regulator	
060511	50986C	Holder Regulator	
045589	55996C	Cooler Y-Strainer	
006168	61313C	Cartridge for Water Cooler	
024551	61314C	Green Cartridge	

**EZH20™ Parts
WaterSentry® Filters**

- CTO Filters
- Features:
 - Quick-disconnect
 - 1/4 Turn installation
 - Hand never touch the actual filter media
 - Outer protective wrap
- NSF/ANSI 42 and 53 certified

Part #	Mfg #	Flow Rate	Rated	Full Load	Ship Wt	Description	Price
162211	EWf3000					Complete Kit, 3000 Gallon Filtration System	
189544	WSF6000R2PK	6000 Gallon,				2-pack	
132220	51300C	3000 Gallon,				1-Pack	
164978	51300C12PK	3000 Gallon,				12-Pack	
132222	51300C3PK	3000 Gallon,				3-Pack	

Repair Parts



Empire Comfort Repair Parts

Replacement Parts

Blower

Part #	Mfg #	Description	Price
127041	FBB-4	Variable-Speed Blower	

Fenner Drives Repair Parts

Belts

PowerTwist Plus® V-Belt

- *No tools required, assembles in minutes*
- *High strength and low elongation under load*
- *High performance polyurethane elastomer reinforced with multiple plies of polyester fabric*



Part #	Mfg #	Type	Length	Pack	Price
143772	0418010SL	3L	5'	Slv	
143792	0418030SL	A/4L	5'	Slv	
143793	0405030	A/4L	25'	Box	
143795	0418050SL	B/5L	6'	Slv	
143796	0405050	B/5L	25'	Box	

Franklin Electric Repair Parts

Capacitor Kits

Part #	Mfg #	HP	Volts	Price
098889	305-207-905	1/2	230V	
098890	305-207-918	3/4	230V	
118594	305-207-913	1	230V	
097608	305-218-976	1/2	230V	
096114	305-218-978	3/4	230V	

Relays

Relay Kit

Part #	Mfg #	Volts	Price
096115	305-102-902	230V	

General Filter Repair Parts

Manual Control Humidistats

- Senses variation in relative humidity levels
- Humidity range: 10% - 85%
- Duct cut-out dimensions: 2-1/4" x 1-3/4"
- Duct plate dimensions: 4" x 5-1/2"
- Mounting screws included



Wall-Mount Housing

- Allows for both wall and duct mount

Part #	Mfg #	Description	Price
146561	WMH3	Wall-Mount Housing for MHX3, MHX3C, or DHX3	

GeneralAire Replacement Parts 1042 Series Humidifier Replacement Parts

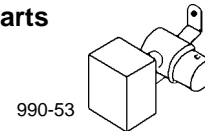

Part #	Mfg #	Description	Price
004874	990-53	Solenoid Valve Assembly - 24V for 1042/1137 (Includes Fittings)	

Replacement Evaporator Pad

- Aluminum evaporator material enclosed in heavy wire frame and channeling
- Pad has super absorbent coating



Part #	Mfg #	Description	Price
004870	990-13	11-3/4"H x 9-3/4"W Evaporator Pad for Model SL-16, 1042, 1040, 1137	
125681	1099-20	12"H x 14-1/4"W Evaporator Pad for Model 1099, 950	

Repair Parts



Gerber Repair Parts

Gerber Replacement Parts

Cartridge Assembly



92-298

Part #	Mfg #	Description	Price
028493	92-298	Hardwater® Ceramic Cartridge with Limit Stop, Chrome	
088009	95-154	Replacement Cartridge for GS103/GS105	
029460	97-022	Safetemp™ Control Cartridge, Chrome	

Faceplate

Part #	Mfg #	Description	Price
004816	97-130	Faceplate Assembly, Chrome	
026255	97-171-KT	Faceplate Assembly, Chrome	

Handle

Part #	Mfg #	Description	Price
031332	86-986	Ceramaflow™ Disc Cartridge, Handle, Cold, Chrome	
031331	86-987	Ceramaflow™ Disc Cartridge, Handle, Hot, Chrome	

Shower Arm



Part #	Mfg #	Description	Price
004716	49-205	Lock Shower Arm Ell, Thin Wall Install, Less Spray Plate, Rough Brass	

Stem and Bonnet Assembly

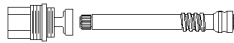

Part #	Mfg #	Description	Price
004827	98-673	Stem & Bonnet Assembly, Hot	

Unit Bag

Part #	Mfg #	Description	Price
004849	99-537	Unit Bag 298-290/590/790/794/795/796, White	
063774	99-538	UltraFlush Unit Bag, White	
105006	99-660	Gerber Unit Bag for Avalanche	

Parts

Part #	Mfg #	Description	Price
004776	90-161	Brass Seat 5/8"-20 NS-2 Thread	
026022	90-390	Fibre Follower	
004792	91-132	Middle Wire	
091418	92-294	Limit Stop for Safetemp	
023522	97-013	Complete Hardwater® Assembly, Less Control Cartridge	
023523	97-014	Complete Safetemp Assembly, Less Control Cartridge	
085928	97-305	Pop-Up Extension Assembly	
004843	99-161	Lav Hanger	
137907	99-788	Flapper	

Repair Parts

*Physical Vapor Deposition (PVD) Limited Lifetime Finish

www.plumbsupply.com • Serving our Customers Since 1946 • www.waterconcepts.net

Hi-Velocity (Energy Savings Products) Repair Parts

Electrical Components



EPC Control Board

Part #	Mfg #	Part Name	Description	Price
107815	20120100111	EPC Control Board	Control Board for All HE/LV-E Fan Coils with EPC Motors	
127481	20120100001	EPC Circuit Board	Circuit Board for all HE/LV-E Fan Coils with EPC Motors	
127483	20120100030	EPC Transformer	Transformer for all HE/LV-E Fan Coils with EPC Motors	

Hydron Module Repair Parts

Heat Pump Repair Parts

Part #	Mfg #	Description	Price
131157	11470002001	ECM Board	
099573	01CB28	Time Delay Board	
131158	11470003001	Combo Board	
146360	47P002-01NN	47p002-01nn Hydron Combo Board	
131156	11470001001	Control Board	
102660	01CB30	Control Board	
104349	32EB20	15/20kW Elec Board	
158573	40M100-01NN	ECM Motor Hydron	
177055	85A006-02VN	ECM Blower Motor	
136798	35P002-04NN	35p002-01nn Low Pres Switch	
136799	35P003-01NN	High Pres Switch	
136926	11350001002	Low Pres Switch Thrd	
136800	50FL001	Drain Pan Switch	
136823	05P001-01NN	Flow Switch	
141084	18R006	Valve	
141085	33P001-01NN	Valve Hydron	
167466	31P004-01CN	Hydron Air Coil	
167465	18V004	Hydron 3-Way Valve	
141083	18R00C	Coil f/Valve	
111761	26C008	3-Pole Contactor	
136803	11430001001	2-Pole Contactor	
131727	11410000001	Wiring Harness ECM	
136801	11450000001	75VA Transformer	
135343	34P060-11B	H062 410A 2-Stage Comp	
176400	50CB10	Compressor Blanket	
176401	50CB40	Compressor Blanket	
172648	51P010-01HN	Blower Wheel	

Capacitors

Part #	Mfg #	Description	Price
136806	26C101	Capacitor H018 Rev A&B	
136807	26C103	Capacitor All 024 Rev A&B	
136808	26C104	Cap H030&36/w036 Rev A	
136809	26C111	Capacitor	
136810	26C112	Capacitor	

Repair Parts

Honeywell Repair Parts

Fan Centers

R8239 Control Center

- Provides low voltage control of line voltage fan motors and auxiliary circuits in heating, cooling or heat-cooling circuits
- Includes NEMA D Transformer, relay enclosures
- Convenient connections for thermostat and heating-cooling equipment wiring
- Mounts on standard 4" x 4" junction box in any indoor location without additional enclosures
- Relay is easily replaced without disturbing wiring



Part #	Mfg #	Description	Price
112616	R8239B1076	120/208/240V, DPDT Switching, 50VA Transformer, Includes R8222D	

R8285 Control Center

- Transformer powers low voltage control systems and provides overload protection
- Low voltage terminal board provides convenient connections for thermostat and heating/cooling equipment wiring
- Mounts on standard 4" x 4" junction box
- Relay is easily replaced without disturbing wiring



Part #	Mfg #	Description	Price
006780	R8285A1048	120V, SPDT Switching, 40VA Transformer, 24V Secondary, Includes R8222B Plug-In Relay for 1 or 2 Speed Fans	

Repair Parts

Humidifier Parts & Accessories

Humidifier Parts & Accessories

Humidifier Parts

Part #	Mfg #	Description	Price
037355	32001615-001	Drain Fitting for HE220 and HE260 Humidifiers	
037357	32001639-002	Solenoid Valve Assembly for Honeywell Humidifiers, Includes Water Feed Tube & Nozzle	

Repair Parts

Honeywell Repair Parts

Honeywell Accessories
Motors

Part #	Mfg #	Description	Price
006844	802360JA	24V Sealed Replacement Motor for V8043/V8044	
163574	802360LA	120V, 60 Hz Replacement Motor for V4043, V4044	

Replacement Head for V Series Zone Valves

Part #	Mfg #	Description	Price
006841	40003916-026	24VAC, 50/60 Hz Replacement Head with End Switch for V8044E	
031407	40003916-048	24VAC, 50/60 Hz Replacement Head with End Switch for V8043F	

Checkout Kit for Economizer Logic Modules

- Includes resistor and jumpers
- Used with W7459, W7210, W7212, and W7215



Part #	Mfg #	Description	Price
223324	4074EJM	Economizer Checkout Kit for W7459, W7210, W7212, and W7215	

Honeywell Parts

Part #	Mfg #	Description	Price
074665	32001754-001	Current Sensing Relay for Whole-House Humidification Units	
006842	40003918-006	Adapter Kit for V4043, V8043, 2-Way Hydronic Valves	
127196	50027997-001	Solenoid Valve for TrueSTEAM	
143930	50027998-002	True Steam Water Level Sensor	
152377	Y8427U9045	Universal Service Kit, Carton Consists of: (1) S8610U3009/U. (1) ST9120U1011/U. (1) Q3200U2002/U. (1) S9200U1000/U. (1) Multi tool.	

Repair Parts

Jones Stephens Repair Parts

Nuts and Washers

Basin Nut



Part #	Mfg #	Description	Price
044429	B10-102	1/2"-14 x 1/2" Regular Zamak	

Basket Strainer Locknut

- Die cast zinc



Part #	Mfg #	Description	Price
093968	B10-094	Basket Strainer Rubber Washer	

Carrier Nut & Washer Set

- 5/8-11 Threads



Part #	Mfg #	Description	Price
125755	C56-100	4-Pk Nuts & Washers	

Hex Nut



Part #	Mfg #	Description	Price
191511	F33-082	3/8" - 16	

Zinc Plated Flat Washer

- 3/8" (1" OD)



Part #	Mfg #	Description	Price
191507	F33-094	3/8" (1" OD)	

O-Ring Kit

- Packed in re sealable plastic case with fitting chart on lid



Part #	Mfg #	Description	Price
093646	O25-200	200-Pc O-Ring Plumber's Pack	

Kohler Repair Parts

Kitchen Side Sprays

Standard Kitchen Side Spray & Hose



Part #	Mfg #	Description	Price
187506	1011130-VS	Sidespray Assy, *Stainless	
156774	1021724-VF	Sidespray w/Hose, Brass	
122911	GP1021724-7	Sidespray w/Hose, Black Black	

Spray & Hose



Part #	Mfg #	Description	Price
171513	1013838-BV	Spray Assy, *Br Brz	
153883	1014048-CP	Hose Secondary, Chrome	
155335	1036940-0	White Spray Head Kit	
153433	1037518-CP	Hose Kit, Polished Chrome	
098050	1041319-CP	Pull-Out Spry Head Chrome	
173755	1041319-G	Pull-Out Spry Head Chrome	
152453	1041320-CP	Hose Kit, Polished Chrome	
101298	1056336-CP	Hose Kit, Chrome	
151852	1074398-VS	Spray Kit, *Stainless	
153955	1109445-BN	Spray w/ Screen *Br Nickel	
134128	1114379-BC	Hose Kit, Bright Chrome	
164835	1148629-BC	Hose Kit, Bright Chrome	
166252	1155250-CP	Bellera Spray Head Chrome	
168641	1114111-BC	Hose Kit, Bright Chrome	
182429	1141915	Hose Kit	
183339	1153208	Hose Guide	
156335	1155250-VS	Spray Head, *Stainless	
172261	1155250-2BZ	Spray head, Oil-Rbd Bronze	
165112	1155355-CP	Spray Head, Pol Chrome	
155345	1155355-VS	Spray Head, *Stainless	
162203	1179931	Sprayhead Adapter	
159726	1186344	Hose Assembly	
222878	1218822-CP	Spray Assy, Chrome	
181715	1218823-CP	Spray Assy, Chrome	
170388	1218824-CP	Spray Assy, Chrome	
173920	1218824-VS	Spray Assy, *Stainless	
167009	1219935-BC	Hose Kit, Bright Chrome	

Kitchen Side Sprays (Continued)

Spray & Hose

Part #	Mfg #	Description	Price
167797	75167-D	Replacement Spray, White	
157802	GP1092201	Hose Kit	
055348	GP78825-CP	Hose Kit Chrome	

Side Spray Assembly



Part #	Mfg #	Description	Price
175894	1005010-CP	Hose Service Kit, Chrome	
153716	1005010-VF	Hose Service Kit, * Brass	
135248	1011130-G	Side Spray Assy Br Chrome	
152182	1011130-BN	Side spray Assy *Br Nickel	
155090	1085211-CP	Side Spray Assy, Chrome	
166253	1088395-VS	Side Spray Kit, *Stainless	

Shower Installation

Cartridge for Highflow 3/4" Pressure Balance Valve



Part #	Mfg #	Description	Price
134263	1144925	PBU for K-306-KS & K-2971-KS	

Urinal Installation

Part #	Mfg #	Description	Price
056119	21403	Urinal Cleanout Plug	

Urinal Spud Assembly



Part #	Mfg #	Size	Price
145344	18759	1-1/4"	

* Vibrant Limited Lifetime Warranty

www.waterconcepts.net • Serving our Customers Since 1946 • www.plumbsupply.com

Kohler Repair Parts

Toilet/Urinal Installation & Accessories

Urinal Strainer



Part #	Mfg #	Description	Price
183714	53147-S	Urinal Strainer, Pol Stainless	
169956	GP1211759	Urinal Strainer	
173481	GP1217811	Urinal Strainer	

Tank Gasket



Part #	Mfg #	Description	Price
123062	GP1018165-F	Drylock Tank Gasket	

Ballcock Retro Fit Valve

- For Rialto/
San Raphael3.5 toilets



Part #	Mfg #	Description	Price
055292	84499	Plastic	

Cap Assembly



Part #	Mfg #	Description	Price
072213	1013092-0	Bolt Cap Accy Pack, White	
153559	1013092-G9	Bolt Cap Accy Pack, Sndbr	
186397	1013092-NY	Bolt Cap Accy Pack, Dune	
108130	GP1013092-96	Bolt Cap Accy Pack, Biscuit	
223630	5420-0	Low-Profile, White	
223631	5420-96	Low-Profile, Biscuit	
226816	5420-K4	Low-Profile, Cashmere	

Flushometer Installation Extension Kit

- Solid brass construction
- Allows for 1/2" to 2-1/2" extension
- No need for flushometer disassembly
- Fits all standard flushometer inlets



Part #	Mfg #	Finish	Price
131937	10162-CP	Polished Chrome	

Faucet Valves

Complete Valve Assembly for Retrofitting Faucet

- 1/2" Valve

Part #	Mfg #	Description	Price
137033	1131481	Valve Body w/Hot Stem	
172151	1170273	Valve Replacement	

Valve Repair

Aerators

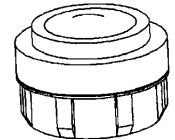

Part #	Mfg #	Description	Price
182884	41007-CP	2.2gpm 15/16 Male, Chrome	
182688	59619-0	Aerator Kit, White	
160583	59728-CP	Aerator, Polished Chrome	
182891	74405-BN	Aerator Assy, *Br Nickel	
151599	78868	Aerator	
091813	78250-CP	Aerator, Polished Chrome	
167560	79402-BN	Aerator Kit, *Br Nickekl	
153112	86125-BL	Aerator Assy, Black	
182746	1008772-CP	Aerator Assy, Chrome	
182873	1010751-CP	Aerator, Polished Chrome	
157663	1013354-CP	Aerator Kit, Chrome	
166360	1018320-VF	Aerator, *Polished Brass	
185614	1019975	Aerator Key	
152069	1021672-CP	Aerator Kit, Chrome	
156775	1031237-VF	Aerator Assy, *Pol Brass	
179683	1031237-VS	Aerator Assy, *Stainless	
164704	1049937	Aerator Insert	
183217	1054421	Aerator Kit	
154016	1061023	Aerator Kit	
183234	1089003	Aerator Kit	
159120	1097762-BN	Aerator Kit, *Brushed Nickel	
172609	1097762-CP	Aerator Kit, Pol Chrome	
151595	1098361-G	Aerator Kit, Br Chrome	
157799	1100416	Aerator Kit	
156817	1103116	1.5gpm Large Insert	
225412	1103470-VF	Aerator Kit, 1.5 GPM	
154664	1103459-BN	Aerator Kit, *Br Nickel	
168958	1103463-CP	Aerator Kit, Pol Chrome	
167835	1103464-BC	Aerator Kit, Bright Chrome	
183241	1103468-BV	Aerator Kit, *Br Bronze	
188297	1103468-SN	Aerator Kit, *Pol Nickel	
168114	1103470-CP	Aerator Kit, Pol Chrome	

Repair Parts

* Vibrant Limited Lifetime Warranty

www.plumbsupply.com • Serving our Customers Since 1946 • www.waterconcepts.net

Kohler Repair Parts

Valve Repair (Continued)

Aerators

Part #	Mfg #	Description	Price
152180	1103470-BN	Aerator Kit *Brushed Nickel	
149773	1104546	1.5 gpm Medium Insert	
172748	1105050-BN	Aerator Kit, *Brushed Nickel	
159677	1105050-VF	Aerator Kit,*Polished Brass	
183242	1105674	Aerator Assy	
160675	1106716-CP	Aerator Kit,Pol Chrome	
183244	1108235-BC	Aerator Kit, Bright Chrome	
179514	1138478	Aerator Assy	
153618	1139282	Aerator	
187955	1139285	Laminar	
173751	1139286	Aerator	
173752	1139287	Laminar	
164808	1139289	Laminar	
162923	1160595	Aerator	
164064	1171998-BC	Aerator Assy, Bright Chr	
187011	1203940-BC	Aerator Assy, Bright Chr	

Seat

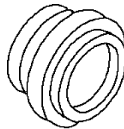

Part #	Mfg #	Description	Price
055320	20774-RP	Renewable Seat	

Vacuum Breaker

- For older one-piece 3.5+ gpf toilets
- Replaced black style



Part #	Mfg #	Description	Price
055422	GP49114	2" Ball Flapper	

Valve Repair Kit

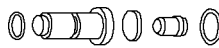

30166



1000187

Part #	Mfg #	Description	Price
182594	30147	Valve Service Kit	
182596	30372	Valve Service Kit	
182627	40409	End Valve Assy	
182681	58076	Valve Assy	

Valve Repair (Continued)

Valve Repair Kit

Part #	Mfg #	Description	Price
171801	76567	Valve Assy	
056161	1000187	Valve Repair Kit	
162934	1178733	Valve Assy	
165027	1021121	Valve, Volume Control	
160355	GP1093674	Valve, Kitchen	
222832	GP1152350	Valve, Centerset Faucet	
222831	GP1192521	Valve, 25 MM White	
055381	GP78579	Valve Repair Kit	
055308	GP30166	3.5+GPF Fill Valve Repair Kit	

Washers, Nuts & Gaskets

Part #	Mfg #	Description	Price
182530	20496-BC	Lock Nut, Bright Chrome	
182532	20564	Washer	
182533	20565	Washer	
182536	20644	Gasket	
182569	21766	Nut	
182572	21779	Gasket	
182574	21844	Nut	
153386	23094	Nut	
182584	24003-CP	Nut, Polished Chrome	
153819	32008	Nut	
182601	32060	Washer	
163448	32313	Nut	
182603	32841	Gasket	
182604	33331	Washer	
182606	33504	Washer	
182607	33772	Washer	
182608	34037	Gasket	
182610	34074-CP	Nut, Polished Chrome	
154416	34274	Washer	
182618	36262	Washer	
182626	40295	Washer	
170645	41376	Gasket	
154513	50751	Nut	
112456	50752	Washer	
182646	50843	Washer	
182647	51250	Gasket	
113702	51531	Gasket	
169200	52705-CP	Nut, Polished Chrome	
055325	53410	Washer	
159433	55164	Nut	
182656	55413	Washer	

* Vibrant Limited Lifetime Warranty

www.waterconcepts.net • Serving our Customers Since 1946 • www.plumbsupply.com

Kohler Repair Parts

Valve Repair (Continued)

Washers, Nuts & Gaskets

Part #	Mfg #	Description	Price
182687	59606	Gasket	
181864	65157	Nut	
165926	65885	Gasket	
178854	71108	Nut	
177272	71813	Gasket	
166860	78058	Washer	
166861	78057	Washer	
166859	78087	Gasket	
182733	78913	FacePlate Gasket	
182745	1007995	Washer	
182740	1000949	Washer, Plastic	
154945	1009882	Gasket, Molded	
165460	1015190	Washer	
183181	1018336-RP	Nut, Rough Plate	
181866	1020677	Gasket	
183184	1025642	Washer	
166877	1037307	Gasket	
152641	1050048-B	Nut	
183214	1051504-RP	Nut, Rough Plate	
178035	1070291	Gasket Kit	
155661	1106733	Washer	
154740	1113583	Locknut & Gasket Kit	
183328	1128531	Washer	
180292	1222738	Gasket	
187471	1181517-RP	Nut, Rough Plate	

Sink Service Parts

Rough-In Kit



GP1030932

Part #	Mfg #	Description	Price
166957	1066498	Rough-In Kit	
170792	1139260-CP	Rough-In Kit, Pol Chrome	
158598	1131486	Rough-In Kit	
168420	1187917	Rough-In Kit	
169472	1194630	Rough-In Kit	
127033	56373-CP	Rough-In Kit, Pol Chrome	
182707	73418-CP	Rough-In Kit, Pol Chrome	
098493	GP1007937-CP	Rough-In Kit Pol Chrome	
090369	GP1025388	Rough-In Kit Pol Chrome	
087416	GP1030932	Rough-In Kit Pol Chrome	

Parts

Part #	Mfg #	Description	Price
154944	1000193-BV	Escutcheon, *Br Bronze	
166994	1000282-CP	Handle Kit, Pol Chrome	
189946	1001384-47	Service Kit, Almond	
153127	1001384-96	Service Kit, Biscuit	
155078	1001384-89	Service Kit, Desert Bloom	
166039	1001726-G	Handle Service Kit	
185783	1001795-BN	Handle Kit, * Br Nickel	
190273	1001795-47	Handle Kit	
177854	1001978-CP	Escutcheon, Pol Chrome	
153385	1002856	Bracket-Hold Down	
182739	100315	Clicker-Drain Assy	
182018	1003594	Spout Seal	
166541	1004101-C-CP	Cold Plug Button, Chrome	
166540	1004101-H-CP	Hot Plug Button, Chrome	
151709	1005129	O-Ring	
166832	1006008	Lift Rod Kit	
182741	1006057-CP	Door Hinge, Pol Chrome	
182742	1006134-CP	Door Hinge, Pol Chrome	
177856	1006262	Stem Adapter Assy	
180497	1006269-CP	Escutcheon, Pol Chrome	
182744	1006396	Pin	
167396	1006784-CP	Escutcheon Assy, Chrome	
180037	1007376-CP	Handle Kit, Pol Chrome	
162642	1007718-CP	Handle, Pol Chrome	
156197	1007999	Stem Driver	
117857	1008205	Screw	
187098	1009781CP	Faceplate, Pol Chrome	
189790	1009814-CP	Escutcheon, Pol Chrome	
183175	1009872-AF	Bonnet, *French Gold	
154055	1009888-CP	Base Handle, Chrome	
165459	1010161-BN	Trim Ring, *Br Nickel	
188789	1010315-CP	Escutcheon, Pol Chrome	
181490	1010672	Air Pressure Switch	
182875	1011032-0	Whirlpool Trim Kit, White	
182874	1011031-96	Whirlpool Trim Kit, Biscuit	
165984	1012391-BN	Handle, *Br Nickel	
166803	1012916	Split Coupling	
170229	1012977	Adapter	
167478	1013452-0	Dial Trim Assy, White	
167477	1013453	Detent Spring	
181867	1013469-0	Trim Ring, White	
164795	1013489	Stem	
165835	1014065	Tank Plate	
182876	1014072-7	Toilet Seat, Black Black	
178298	1014086-08	31.875 Threshold Seal	

Repair Parts

* Vibrant Limited Lifetime Warranty

www.plumbsupply.com • Serving our Customers Since 1946 • www.waterconcepts.net

Kohler Repair Parts

Parts (Continued)

Part #	Mfg #	Description	Price
165458	1014087-BN	Bonnet, *Br Nickel	
183178	1014554-SN	Spout & Hardware, *Nickel	
160891	1014555-CP	Spout & Hardware, Chrome	
182877	1014556-CP	Spout & Hardware, Chrome	
167744	1014917-G	Lift Rod Assy, Br Chrome	
175018	1015084-BN	Button, *Brushed Nickel	
167746	1015084-G	Button, Brushed Chrome	
172143	1015467-2BZ	Handle Assy Oil-Rbd Bronze	
165456	1015782	Screw	
153165	1016455-CP	Escutcheon Assy, Chrome	
183180	1017273	Screw	
181863	1018662	Control Assy	
182879	1020006-G	Shower Arm, Br Chrome	
182880	1020007-VF	Shower Arm, *Pol Brass	
182881	1020609	Tube	
183182	1020678-F-47	Cover Assembly, Almond	
167479	1023381	Service Tool	
190293	1022562-VF	Trip Lever Kit, Pol Brass	
173541	1024303-0	Button, White	
162318	1024303-2BZ	Button, Oil-Rubbed Bronze	
162335	1024303-BN	Button, *Brushed Nickel	
183183	1024303-VF	Button, Polished Brass	
170404	1024424-BN	Spout Kit, *Brushed Nickel	
183167	1025637-AF	Trim Ring, *French Gold	
154765	1025637-BN	Trim Ring, *Brushed Nickel	
153164	1030689-CP	Escutcheon, Pol Chrome	
183185	1031444	Glass Soap Dish	
176758	1031869-CP	Escutcheon, Pol Chrome	
183186	1031962	Bearing	
183187	1032126-VF	Drain Handle Assy, Brass	
175899	1032250	Seal	
187628	1032253-BC	Body Assy, Bright Chrome	
183188	1032267	Replacement Screw	
186677	1032493-0	Bubble bath Interface, White	
177257	1032546	Valve Stops	
223376	1032872-BC	Valve Stem Adapter	
190205	1033209	Tube, 10.50	
171281	1033743-BN	Escutcheon, *Br Nickel	
153729	1034578	Retainer	
184322	1035359-BN	Escutcheon, *Br Nickel	
166029	1035359-CP	Escutcheon, Chrome	
183191	1035359-VS	Escutcheon, *Stainless	
183192	1035564	Drain Link	
168072	1035605	Screw Set	

Parts (Continued)

Part #	Mfg #	Description	Price
170434	1035796-CP	Handle, Pol Chrome	
163159	1036044	Clamp	
182830	1036210	Blower Kit	
183193	1036218	Check Valve Assy Kit	
183194	1036221	Cover/CB Assy	
172555	1036453-CP	Handle Assembly, Chrome	
171280	1036906	Putty Plate	
187935	1036932-BN	TrimRing, *Brushed Nickel	
183195	1036994-AF	Plunger Assy, *French Gold	
159708	1036994-VF	Plunger Assy, Pol Brass	
154785	1037021-CP	Plunger Assy, Pol Chrome	
175689	1037021-BN	Plunger Assy *Br Nickel	
183197	1037021-G	Plunger Assy Br Chrome	
172528	1037022-BKB	Plunger Assembly, Br Black	
161237	1037023-BN	Drain Assy, *Br Nickel	
183198	1037023-G	Drain Assy, Br Chrome	
175333	1037334	Plunger Arm Assy	
170632	1037431-BV	Spray Holder Assy, *Br Brz	
225585	1037431-G	Spray Holder Assy, Brushed Chrome	
173129	1038326	Bearing	
153316	1039475	Mounting Kit	
184794	1039714-BN	Lever Handle, *Br Nickel	
163161	1039745	Set Screw	
189802	1039896-58	Button, Thunder Grey	
166289	1040484-CP	Spout Kit, Pol Chrome	
183200	1041109-G	Escutcheon, Br Chrome	
174324	1041180-BN	Lift Rod, *Brushed Nickel	
185607	1041321-CP	Handle Kit, Br Chrome	
165318	1041573-G	Spray Face, Br Chrome	
177167	1041840	Drain Rod	
160745	1041995-96	Air Switch Kit, Biscuit	
183201	1042007	Check Valve Kit	
177074	1042634	Wall Sleeve Assy	
163145	1044060	O-Ring	
168711	1044616	Retainer	
163427	1045251	Cable Assembly	
163158	1045768	Relaxing Sprayhead Kit	
165316	1045769	Invigorating Sprayhead Kit	
177258	1046101	Seal Kit	
183203	1046153	Weight	
183204	1048208-B	Screw	
183205	1048208-C	Screw	
183206	1048656-P	Sealing Liquid	
183695	1049146	Floor Mounted Fixing Pack	

* Vibrant Limited Lifetime Warranty

www.waterconcepts.net • Serving our Customers Since 1946 • www.plumbsupply.com

Kohler Repair Parts

Parts (Continued)

Part #	Mfg #	Description	Price
163160	1051487	54 Nozzle Membrane	
183207	1051503-BN	Bonnet, *Brushed Nickel	
165317	1051682	22 Nozzle Membrane	
185403	1052086	Power Supply Kit	
183215	1052857	Reduce Bushing	
183216	1054165-SN	Lift Rod Assy, *Pol Nickel	
183218	1055628	Solenoid Assembly	
135539	1055666	Solenoid	
187554	1055800-BN	Handle Kit, *Br Nickel	
153186	105770401-CP	Towel Bar Assy, Chrome	
169720	1060438-CP	Escutcheon, Pol Chrome	
176650	1060800	Spacer Kit	
180607	1063058-BV	Hanshower, *Br Bronze	
179610	1063058-VF	Handshower, Pol Brass	
169793	1067372-96	Toilet Seat, Biscuit	
183220	1068202-BN	Stopper, *Brushed Nickel	
163642	1068202-BV	Stopper, *Brushed Bronze	
177685	1068525-BN	Assembly Cover, *Br Nickel	
163641	1068525-BV	Assembly Cover, *Br Brz	
187234	1068945	Retainer	
183221	1069315	Spring	
183222	1069723-0	Trip Lever, White	
183223	1070844	Hardware Bag	
183224	1071000	Storage Locker Parts Kit	
169116	1071652	Hex Bit	
171261	1074034	Tool Assy	
183225	1074721-BN	Handle Bonnet, *Br Nickel	
183226	1074724-BN	Handle Adapter, *Br Nickel	
183227	1075614	O-Ring	
183228	1075615	O-Ring	
178585	1077791-96	Plug Buttons, Biscuit	
171786	1077792-BN	Plug Buttons, *Br Nickel	
183229	1077813	Solenoid Valve Kit	
183230	1077815	Valve Cover Kit	
183231	1077816	Diaphragm Kit	
128818	1078578	Flush Valve Assembly Kit	
155319	10813650-0	Floor Mounting Kit Assy	
183232	1081873-BN	Handle, *Brushed Nickel	
222456	1081873-CP	Handle, Chrome	
114111	1083980	Canister Valve Assy Kit	
156362	1086408-CP	Handle, Pol Chrome	
156410	1086409-58	Ring, Thunder Grey	
222940	1085211-VS	Side Spray Assembly	
155113	1086972	Hinge Mount	
163815	1088996	Valve Kit	

Parts (Continued)

Part #	Mfg #	Description	Price
163124	1089635	Cable Kit	
181309	1090621-2BZ	Lift Rod Assy, ORB	
183235	1093029	Assembly Body	
161131	1093053-BV	Spout & Diverter *Br Bronze	
160252	1094550-CP	Straight Stop, Pol Chrome	
183236	1094562	Bonnet	
170190	1094612-CP	Valve, Polished Chrome	
166887	1094631-CP	Spout Assembly, Chrome	
154678	1094633	Seat & Sleeve Assembly	
166611	1094724	Side Body	
175893	1096037-CP	Handshower Kit, Chrome	
183240	1098124	O-Ring	
153739	1010210-BN	Adapter, * Brushed Nickel	
183176	1010343-CP	Handle, Polished Chrome	
182747	1010376	Flapper	
155669	1011059-58	Ring, Thunder Grey	
165461	1011530-BN	Handle, *Brushed Nickel	
157984	1013457-E-96	Flagship Assy, Biscuit	
159535	1013970	Screw	
152457	1013975	Adapter	
154533	1014049	Steam Adapter	
183179	1014923-CP	Showerhead Assy, Chrome	
157985	1015009	Plug Assy	
169377	1016310	Plate	
156133	1016953	Pump Assy	
167700	1017813-01-MX	Assy, Matte Nickel	
156195	1018651-CP	Handle Polished Chrome	
159106	1018651-BN	Handle *Brushed Nickel	
157818	1018651-BRZ	Handle, Oil-Rubbed Bronze	
165985	1019021-BN	Waste Plug, *Br Nickel	
151743	1020678-E-96	Cover/CB Assy, Biscuit	
156951	1020679-A	Cover/CB Assembly	
159540	1024303-47	Plug Button, Almond	
160135	1024303-96	Plug Button, Biscuit	
157926	1024303-CP	Plug Button, Pol Chrome	
111678	1024419	Mixer Trim Housing Hub	
159622	1025210-BN	Escutcheon Assy, *Br Nkl	
154531	1025639-BC	Drain, Bright Chrome	
159534	1032871-BC	Adapter, Bright Chrome	
151597	1033731	Plug Assembly	
151598	1033732	Mixer Valve	
158221	1034484	Retaining Clip	
154831	1035023-CP	Handle Assy, Pol Chrome	
152485	1035783	Front Plate Seal Assy	
152917	1036160	Push Rod Kit	

Repair Parts

* Vibrant Limited Lifetime Warranty

www.plumbsupply.com • Serving our Customers Since 1946 • www.waterconcepts.net

Kohler Repair Parts

Parts (Continued)

Part #	Mfg #	Description	Price
152344	1036212	Kit, Blower-International	
172556	1036452-CP	Handle Assy, Pol Chrome	
153655	1036994-CP	Plunger Assy, Pol Chrome	
183196	1036994-G	Plunger Assy, Br Chrome	
152915	1037044-CP	Handle Assembly, Chrome	
183199	1038690	Vent Assembly	
159505	1039095-CP	Assy, Polished Chrome	
173128	1041321-BN	Handle Kit, *Brushed Nickel	
155666	1041321-G	Handle Kit, Br Chrome	
190209	1042831	Flush Valve Kit	
153884	1043004	Screw Set	
152643	1044585	Exclusives Roller	
223269	1045770	Adapter Kit	
120496	1046987-CP	Handle Kit, Pol Chrome	
223375	1048476	Screw, M4 x 60MM Long	
164017	1049316-CP	Showerhead Assy, Chrome	
152637	1051142-A	Screw	
152456	1051609-BN	Lift Rod, *Br Nickel	
152435	1054623-BN	Diverter Assy, *Br Nickel	
152212	1055637	Diaphragm Assembly	
162256	1055650-CP	Push Button Assy, Chrome	
153605	1055715	1.5 gpm Pullout Service Kit	
152639	1059792	.330 O.D. X .210 Bushing	
186964	1062356-33	Drain Cover, Mexican Sand	
157607	1065219	1.6 Electronic Unit Assy	
155414	1068204	Cartridge Assy	
171397	1068380-0	Access Panel, White	
152838	1072961-CP	Button Assy, Pol Chrome	
152644	1077763-A	8-32 X .250 SEX Bolt	
165893	1077792-BV	Plug Buttons, *Br Bronze	
159625	1077792-47	Plug Buttons, Almond	
152717	1080774	Union Assy	
157870	1081349	Adapter Assy	
222933	1088956	Aerator Kit	
152040	1093052-VF	9" Kit, Polished Brass	
183173	1100507-0	Hinge Cover, White	
155987	1100590	Flexible Hose	
148638	1102542	Solenoid Assy	
157194	1104111-BV	Nozzle Assy, *Br Bronze	
185157	1104111-CP	Nozzle Assy, Pol Chrome	
164048	1104111-VF	Nozzle Assy, Pol Brass	
164773	1104235	Solenoid Kit	
168064	1104270	0.125 gpf Flow Assy	
170369	1104271	Electronic Unit Assy	
168063	1104272	Piston Cover Kit	

Parts (Continued)

Part #	Mfg #	Description	Price
154930	1104617	Crank Assy	
172129	1104957	Laminar Insert	
125323	1105656	1.549" x .103" #129 O-Ring	
189739	1105685-BN	Overflow Cover, *Br Nickel	
183243	1105706	Tool Kit	
188100	1105900	Spout Extension Assy	
165033	1106015	DC Sensor Assy w/Batteries	
155660	1106729-BN	Handle, *Brushed Nickel	
168062	1111139	Solenoid Kit	
183322	1114256	Rising Wall Controller	
183324	1115286	Threaded Ring	
160683	1119112	Slip-Fit Clamp Kit	
183325	1120992-BN	Antique Small Hndl, *Br Nkl	
183329	1131838-58	Bumper, Thunder Grey	
152557	1133024	Toilet Seat Hardware Pack	
177252	1133070	Bumper Service Kit	
155662	1138476-BN	Escutcheon Assy *Br Nickel	
158967	1139558	Collect-Push-In	
183696	1139526-CP	Elbow Assy, Pol Chrome	
168212	1139600	Plastic Trapway Service Kit	
155640	1140164-BN	Flange, *Brushed Nickel	
141416	1140858-CP	Slidebar Assy, Chrome	
183331	1140867-BN	WM Bracket Cover, *Br Nkl	
183697	1141213-B	Cartridge, Transfer Valve	
222069	1142457-BN	Spout Assembly	
165853	1142457-CP	Assy Spout, Pol Chrome	
153674	1142457-2BZ	Assembly, Spout ORB	
177423	1142538	Filter Block	
175509	1143165-CP	Showerhead Assy, Chrome	
169560	1143284	Assy, Drain Clicker	
153321	1144142	Seals, PBU Kit	
183336	1145563	Kit, SPR Valve Assembly	
172730	1145638-HW1	Toe Tap Assy	
169192	1146417	120V USA Pump	
183337	1146802-0	Air Jet Service Assy, White	
152316	1147742-0	Air Switch Kit, White	
157788	1147742-47	Air Switch Kit, Almond	
166779	114847-VS	Spray, *Stainless	
183338	1150464-0	EB Hinge Kit, White	
160674	1151429-CP	Retaining Collar, Chrome	
180822	1151441-CP	Shower Arm, Pol Chrome	
163200	1151968-BN	Service Kit, *Brushed Nickel	
163170	1151968-CP	Service Kit, Pol Chrome	
171450	1152299-BN	Spray/Screen Kit, *Br Nickel	

* Vibrant Limited Lifetime Warranty

www.waterconcepts.net • Serving our Customers Since 1946 • www.plumbsupply.com

Kohler Repair Parts

Parts (Continued)

Part #	Mfg #	Description	Price
166599	1153944-BN	Handle Kit, *Br Nickel	
164798	1153944-CP	Handle Kit, Pol Chrome	
187838	1153944-G	Handle Kit, Br Chrome	
167699	1154757-58	Screw Cover Service Kit	
188368	1154836	Hose Assy	
170194	1155520	Pipe System	
177056	1156410-BN	Plug Button, *Br Nickel	
183698	1156410-CP	Plug Button, Pol Chrome	
183555	1161770	Rotary Assy	
183702	1160753	Adapter	
190321	1166635	3/4" Volume Control Insert	
166308	1166879-BN	Tube, *Brushed Nickel	
223932	1166879-CP	Tube, Pol Chrome	
176945	1173678	Cartridge Assy	
183703	1175994-BN	Showerhead Assy, *Br Nckl	
180261	1175870-BN	Lift Rod Assy, *Br Nickel	
181980	1177160	12 Sink Clips	
183704	1177161	12 Installation Clip Kit	
173008	1178736	PCB Board & Cover Assy	
183706	1179957-BN	Drain Strainer, *Br. Nickel	
069038	1179-NA	Tiling-In Bead, 180" Length	
167166	1180445-VF	Escutcheon, Polished Brass	
056792	1181-NA	Tiling-In Bead, 132" Length	
161065	1185540-BN	Assy Slider, *Br Nickel	
188413	1187796-SH	Handle Kit, Bright Silver	
172092	1187796-SHP	Handle Kit, Bright Pol Silver	
158906	1190050-K-CP	Assy, Polished Chrome	
188463	1191575-CP	Shower Arm, Pol Chrome	
171043	1194302-CP	Large Escutcheon, Pol Chr	
182831	1194940	Cable	
170376	1197170	Vacuum Breaker	
183710	1200948	Chain Kit	
172093	1201773-BN	Loure Spout Assy, *Br Nkl	
188554	1202708	Mirrored Door Assy	
169231	1202077	Supply Hose SS	
224199	1202709	Mirrored Door Assembly	
186691	1204788-2BZ	Cold Handle Assy, ORB	
186251	1207169	Supply Hose	
183711	1207943	Diverter Spout Cap	
165035	1209172-VS	Sensate Escutcheon,* Stnls	
222939	1209172-CP	Escutcheon, Oil-Rbbed Brz	
179937	1217618-BL	Strainer Cup, Matte Black	
224985	1218071	Supply Adapter	
186669	1218822-VS	Spray Assy, *Stainless	
176606	1218922-CP	Button, Polished Chrome	

Parts (Continued)

Part #	Mfg #	Description	Price
181868	1219654	T-Style 240V 1.5KW Heater	
179983	1219693	1/4 NPT Pipe Plug	
180294	1222736	1" Heater Adapter	
188461	1224550-CP	Escutcheon, Pol Chrome	
187872	1229031	Supply Adapter	
171581	1229524	Basin Rack Wheels	
183712	1232221-BN	Handle Assy, *Br Nickel	
177253	1239016	Hardware Pack	
188369	1239557-BNK	Bracket Kit, Anod Br Nickel	
178416	1240529	Overflow Shell Service Kit	
185308	1256315	OEM Touchless Assy	
189976	1262603-CP	Steam Head Kit, Pol Chr	
158897	13602-NA	6" Cable Assy	
155785	14511-CP	Escutcheon Plate, Chrome	
054451	201-NA	High-Flow Refill Cartridge	
054452	202-NA	Premium Refill Filter Cartridge	
182526	20345-BN	Flange & Set Screw Assy,*Br Nickel	
156847	20345-CP	Flange & Set Screw Assy, Chrome	
165097	20345-VF	Flange & Set Screw Assy, Pol Brass	
162187	20363-VF	Flange Assy, Pol Brass	
162188	20364-VF	Knob Assy,Pol Brass	
182529	20413-CP	Left Hand Valve Stem, Chr	
182527	20401	Stopper Post	
222959	70442	Stem Extension Kit	
182531	20536-CP	Lift Rod, Pol Chrome	
182534	20615-BN	Screw, *Brushed Nickel	
182535	20617-CP	SA Overflow Hood, Chrome	
182537	20650-CP	Stopper Assy, Chrome	
182538	20652-CP	8-32 x 1.25 Screw, Chrome	
182539	20654-RP	LH Valvet, Rough Plate	
182540	20851-CP	Escutcheon, Pol Chrome	
182558	21072-BN	Stopper Assy, * Br Nickel	
182560	21098-CP	Escutcheon, Chrome	
223383	21694	Lift Toggle Assembly	
182570	21775	1/4-20 x .625 Screw	
182571	21777	3/8 Niedecken Detail	
182573	21843-BC	Screw, Bright Chrome	
182575	21845	Packing	
164410	21152	6-20 x .5 Screw	
164411	21153	Adjusting Block	
164409	21155	Lift Rod	
158316	21166-BKB	Strainer Body, Br Black	

Repair Parts

* Vibrant Limited Lifetime Warranty

www.plumbsupply.com • Serving our Customers Since 1946 • www.waterconcepts.net

Kohler Repair Parts

Parts (Continued)

Part #	Mfg #	Description	Price
173074	21166-CP	Strainer Body, Chrome	
182561	21166-VF	Strainer Body, Pol Brass	
182562	21281-CP	2"D Shroud Cover, Chrome	
182882	21318-AF	Tub Drain Stopper Assy, * French Gold	
158315	21318-BKB	Stopper Assy, Br Black	
182563	21318-VF	Stopper Assy, Pol Brass	
182564	21354	Lift Rod	
182565	21496	O-Ring Assy	
182567	21712-BC	Stem, Bright Chrome	
182568	21745-CP	Cover, Pol Chrome	
172647	22125	Cold Plunger	
172649	22126	Hot Plunger	
172650	22211	Cold Disc Holder	
172651	22212	Hot Disc Holder	
182576	22325	Spline Insert	
182577	22511	Short Adj. Sleeve Valve	
182578	22692	Diverter Seat for FTG	
182579	22859	8-32 x .5 Screw	
182580	22862-BC	Diverter Stem, Bright Chr	
162949	22910-CP	Dial Plate Sleeve, Chrome	
182581	22916-BN	Overflow Plate, * Br Nickel	
182582	22916-CP	Overflow Plate, Chrome	
182583	22942	Seat	
153611	23023-BC	Valve Stem, Bright Chrome	
153119	23058-BC	Valve Stem, Bright Chrome	
182585	24015	Union Joint	
174497	28518	3/32 DIA x 3/4 Pin	
182586	29037-BC	Drain Crank, Bright Chrome	
182587	29039-BC	Drain Crank w/ Adj. Link, Bright Chrome	
182588	29060-BN	Strainer Body Lever Lift, * Brushed Nickel	
182589	29077-BN	3/8-24 x 7/32 Screw, *Brushed Nickel	
182590	29643	Lift Toggle	
182591	30040	Valve Stem Ledge	
182592	30042	Valve Stem	
182593	30139	Sleeve & Diverter Kit	
175179	30152	Plunger Assy	
182595	30154	Lift Rod Assy	
151344	30253-RP	Rebuilding Kit, Rough Plate	
154165	30297-CP	Rebuilding Kit, Chrome	
166211	30299	Rebuilding Kit	
177747	30332-RP	Hardware Kit, Rough Plate	

Parts (Continued)

Part #	Mfg #	Description	Price
167058	30394-RP	CCW Close Valve, Rough Plate	
182597	30419	Tank Accessory Pack	
182598	30467	Diverter	
165924	30739	Dir. Ball Removal Tool	
160203	30775	W/P STD Switch Kit	
163455	31537	Ball & Frame Assy	
182600	31584-BC	Left Hand Valve Stem Assy, Bright Chrome	
157639	31689-CG-CP	Cold Push Handle, Chrome	
182599	31439-BC	Diverter Assy, Chrome	
153818	32005	7/16" ID X 3/4" OD Packing	
182602	32657	O-Ring	
182605	33357-BN	8-32NC-2A x .562 Screw, *Brushed Nickel	
189795	33625	10-24 x .438 Screw	
173081	33681-CP	Strainer Body, Chrome	
182609	34064-BN	Lever Handle, * Br Nickel	
182611	34117	O-Ring	
153817	34190	Valve Spacer	
154166	34230	Spring	
168123	34294	Packing	
182612	34532	Post For Soap Dish	
182613	34533-CP	1/8-27 NPSM Nut, Chrome	
160251	34777	Pressure Regulator Assy	
170189	34902-G	Condensate Plate Assy, Brushed Chrome	
182614	35103	3/8" IP Angle Stop Assy	
182615	35285	10-24 x .313 Screw	
161208	35296-CP	Bubbler Shank, Chrome	
159530	35311-CP	Lever Handle Assy, Chrome	
170191	35314-CP	1-1/4" SEM Fountain Trap, Polished Chrome	
175962	35594	3/8 Union Conn	
182616	36258	Push Button	
182617	36261	Valve Stem	
182619	36263	Spring	
182620	36415	Spout Bearing	
182621	36417-RP	Swing Spout Post, RP	
182622	39881	Valve Stem Packing	
182623	40004	End Valve Body Assy	
182624	40235	Ball Lvr Seat Seal Washer	
136388	40236	Ball-Rod Assembly	
182625	40282	Diverter Bushing	
170179	40343-CP	LG Handle Assy, Chrome	
182883	40479-BN	Bonnet, *Br Nickel	

* Vibrant Limited Lifetime Warranty

www.waterconcepts.net • Serving our Customers Since 1946 • www.plumbsupply.com

Kohler Repair Parts

Parts (Continued)

Part #	Mfg #	Description	Price
182628	40966	Packing	
169521	41240-VF	SA Insert, Pol Brass	
182629	41489	SA Stand Pipe	
182630	42036	Hot Plunger	
182631	42038	Cold Plunger	
182632	42052-CP	OBS Mixer Sleeve, Chrome	
182633	42160	O-Ring	
182634	42258	Sleeve	
182635	42271	Bonnet	
171282	42414	10-24 x .375 Screw	
182636	42451	O-Ring	
165399	42674-CP	Handle, Polished Chrome	
182637	42675	Plug, Handle, Shower	
182638	42676-CP	Plug Button, Chrome	
179506	43040	Trap	
153582	43070BV	Strainer Plate, *Br Bronze	
172119	48096-CP	Strainer SA, Chrome	
189793	48250-CP	Wall Saddle, Pol Chrome	
189796	48251-CP	Rod, Pol Chrome	
165964	48609-BGD	DA Bidet Spray, *Moderne Brushed Gold	
182639	48686	O-Ring	
182640	500180	Bumper Kit	
168997	500306-G3-B11	TouchUp Paint Kit DOE, Ice	
179745	500452	Rebuild Kit, Diverter	
182641	500455-CP	Stem Extension Kit, Pol Chr	
182642	50338	Detent	
177748	50340-VF	Escutcheon, Pol brass	
182643	50344-CP	Bonnet, Chrome	
154845	50355-VF	Bonnet, Pol Brass	
182644	50588-BN	Diverter Body Assy, *Brushed Nickel	
182648	51261	Clip	
182649	51419	Seat	
189794	51967-CP	8 x 1.25 Screw, Chrome	
170192	52054	Access Pack Wall Screw	
182650	52156	5.50 LG Tube	
154844	52478	O-Ring	
164797	52588	Screw	
182651	52703	Overflow Tube	
182888	52865-BN	8-32 x 1.87 Screw, * Br Nkl	
182652	52936-CP	Hndl & Btnn Assy, Pol Chr	
182653	53448-CP	Screw, Chrome	
159108	534-NA	UM 1848/1849 Install Kit	
173257	550-NA	UM 1821/1822 Install Kit	
182655	55108	O-Ring	

Parts (Continued)

Part #	Mfg #	Description	Price
182659	56318-RP	Seat Replacement Kit, RP	
165965	56702	Shank	
225354	57081-CP	Centerpiece Handle, Chrme	
182676	57386	O-Ring & Diaphragm	
222659	57411-BN	Lift Rod, Br Nickel	
183342	57411-G	Lift Rod, Br Chrome	
182677	57711	O-Ring	
161416	577-NA	UM 1164/1165 Install Kit	
182679	57745-CP	Trend Blade Handle, Chrme	
182680	57751	Spray Diverter	
173294	57930-VF	Threaded Escutcheon, Polished Brass	
162186	58015-VF	Sleeve, Pol Brass	
168631	58180-CP	Escutcheon, Chrome	
182682	58249	1/4" IPS Pipe Cap	
182683	58307-VF	OBS Shower Head Assy, Polished Brass	
182685	58895-CP	Pair Handle Kit, Chrome	
162749	591-NA	UM 1136/1173 Install Kit	
156756	592-NA	UM 1134/1174 Install Kit	
161743	593-NA	UM 1834/1835 Install Kit	
182689	59636-G	Mixer Sleeve, Br Chrome	
182690	59637-G	Handle Base, Br Chrome	
182691	59637-VF	Handle Base, Pol Brass	
182686	59418	Lower Bushing	
182692	60380	10-24 x 1.5 Screw	
182693	64503	Hanger	
182694	65054-S	10-24 x 3.25 Screw, Pol SS	
182889	65061-BV	Suction Cover, *Br Bronze	
182695	65156-0	Switch Flange, White	
182522	65156-47	Switch Flange, Almond	
182696	65226-96	Suction Cover Plug, Biscuit	
182697	65879	.395 Retaining Ring	
165925	67429	Flange	
165927	67889	PVC Jet Housing Assy	
182699	70504	SA Cold Plug Button	
182700	70505	Plug Button	
182701	70539	Threaded Sleeve	
180038	70593-CP	SA Brass Inserts, Chrome	
156915	71015	1.174 x 1.03 O-Ring	
182702	71016	O-Ring	
181966	7117-NA	Test Seal Kit	
055352	71906	Stem Adapter	
177273	71908	Acrylic Handle For Mixer	
182703	71911	Mixer Face Plate	
166030	71940	Bulk O-Ring	

Repair Parts

* Vibrant Limited Lifetime Warranty

www.plumbsupply.com • Serving our Customers Since 1946 • www.waterconcepts.net

Kohler Repair Parts

Parts (Continued)

Part #	Mfg #	Description	Price
172588	71947-CP	Lever Handle, Chrome	
190311	71973-CP	Handle Lever	
182890	722901	Silver 3600A Top Bracket	
182704	73065	Medium Stem Adapter	
182705	73066	Large Stem Adapter	
153331	73094	Adapter	
158723	73175	Flexible Shaft	
158724	73177	Drain Rod	
158720	73179	Sleeve	
164075	73203-G	Bezel IR Sensor, Chrome	
172152	73330	Spacer	
178094	73326-BN	Nozzle Assy, *Br Nickel	
158722	73404-CP	Tube Assy, Pol Chrome	
158718	73439-CP	Lift Rod, Chrome	
172755	73455-CP	Escutcheon, Chrome	
182198	73703	Side Valve	
182708	73719-BC	Stem Extension, Chrome	
165687	73744-BN	Spout Kit, *Br Nickel	
182709	73860	Tee Assy	
172068	74385-G	Escutcheon, Br Chrome	
158314	74675-2BZ	Overflow Hood Assy, ORB	
182716	75059	Diaphragm Assy	
182717	7511-58	Shank, Thunder Grey	
182718	75462	Graphic Cover	
162495	75564	Retaining Ring	
177491	75601-BN	Lav Short Bonnet, *Br Nckl	
153434	75610-CP	Bonnet, Pol Chrome	
182719	75740	Adjustment Collar Assy	
158239	75771-CP	Transfer Valve Cap, Chrome	
225355	42669-CP	Stem/Skirt Handle	
168741	76602-CP	Escutcheon Assy, Chrome	
182720	76704-0	Bonnet Cap, White	
073775	76704-CP	Bonnet Cap, Pol Chrome	
152934	76713	1/4-28 X .25 Screw	
182722	76755-VF	Handle Skirt, Pol Brass	
182724	77012-VF	Lav Handle Skirt, Pol Brass	
182727	77099	Bearing	
182729	77148	Stop Stem Kit	
182932	77172-BN	Lav Escutcheon, *Br Nickel	
164796	77642	O-Ring	
157465	77887-VF	Lever Handle Assy, Brass	
159624	77971-47	Graphic Cover, Almond	
160137	77971-96	Graphic Cover, Biscuit	
162319	78042-2BZ	Plug Button, ORB	
161850	78042-96	Plug Button, Biscuit	

Parts (Continued)

Part #	Mfg #	Description	Price
182933	78050-BN	Escutcheon, *Br Nickel	
181411	78139-BV	Lav Handle Assy, *Br Brnz	
159432	78139-2BZ	Handle Assy, ORB	
182934	78139-CP	Handle Assy, Chrome	
182730	78148-CP	Handle Assy, Chrome	
182731	78155	10-24 x .625 Screw	
182935	78172-BN	Stopper Assy, *Br Nickel	
160987	78205-47	Plug Button, Almond	
156226	78205-96	Plug Button, Biscuit	
163179	78205-BV	Plug Button, *Br Bronze	
156120	78205-2bz	Plug Button, ORB	
183343	78205-G	Plug Button, Br Chrome	
182732	78205-VF	Plug Button, Pol Brass	
158237	78562-58	Grip Ring, Thunder Grey	
131130	78797	Rubber Seal	
184161	78923-BN	Collar, *Brushed Nickel	
153015	78925	Hose Guide Assy	
152208	78969-58	Adapter, Thunder Grey	
165028	79150-58	Adapter Kit, Thunder Grey	
182734	800065-CP	Lever Handle, Chrome	
157839	83143	Seal Diaphragm	
183344	834404	M6 Screw	
185858	83451	Cap Assy	
183345	836664	Mounting Hardware	
152205	84100	O-Ring	
182737	84786	Hardware Pack Seat	
081376	85500	High Flow PBU Shower 3/4" Mixer Cap Kit	
167088	85516	Set Screw Spout Assy	
182940	85698-CP	ABS Escutcheon, Chrome	
167086	86036	O-Ring/Bearing Kit	
166292	86633	Bath Stem	
166482	86861-CP	Lift Rod, Polished Chrome	
182944	87117	Backing Plate	
164794	87118-CP	Collar, Chrome	
181643	87390	SP Filter Head	
187099	87448-CP	Sleeve, Pol Chrome	
166995	87536	8-32 x 1.87 Screw	
176620	88057-BN	Plug Button Assy, *Br Nckl	
182945	88093-G	10-24 x 2.63 Screw, Br. Chr	
182946	88227-AF	Shower Escutcheon, *French Gold	
175356	88532-96	Trim Ring Kit, Biscuit	
182948	89279	Hold Down Plate	
158886	91915	Hardware Kit	

* Vibrant Limited Lifetime Warranty

www.waterconcepts.net • Serving our Customers Since 1946 • www.plumbsupply.com

Kohler Repair Parts

Parts (Continued)

Part #	Mfg #	Description	Price
186467	93766-0	1-Button Switch Cover, White	
166427	93838	1" PVC Tube Repair Kit	
182950	94497	Flat Pillow Kit	
180291	94853	Flex 1-1/2" Service Kit	
182738	95045	8 x 8 .75 Screw	
186466	97740	Mode Switch Assy	
176680	99272-CP	Escutcheon, Chrome	
186260	99272-SN	Escutcheon, *Pol Nickel	
056035	B2100	Rod Parts	
170699	CB-DXCLC10F S	Mirrored Cabinet Door	
188928	CB-DXCLC20B AN	Mirrored Cabinet Door	
183171	CB-DXCLC20F S	Mirrored Cabinet Door	
183347	CB-SHLFCLC20	Inner Shelf Pack for CLC20	
183348	CB-SHLFCLC30	Inner Shelf Pack for CLC30	
167063	CB-XSS131-8	8 Repl Shelf Clips	
087887	GP1003736-0	Sprayhead, White	
105414	GP1016515	Kitchen Valve	
120573	GP1035350-CP	Premier Drain Chrome	
086238	GP1036940-CP	Spray Head Kit Pol Chrome	
122914	GP1037021-CP	Std. Plunger Assy, Chrome	
122915	GP1037022-CP	Plunger Brass Assy, Chr	
151936	GP1043211-VS	Simplice Sprayhead, *Stnls	
135542	GP1056873	Piston .5/1.0/1.28/1.6 GPF	
185451	GP1059515	Manual Flush Vacuum Breaker	
117018	GP1074231	Spline Adapters	
122905	GP1077791-0	4"cc Plug Buttons, White	
122906	GP1077792-0	8"cc Plug Buttons, White	
121407	GP1083167	Fill Valve Kit	
152038	GP1092203	Cold Valve Cartridge Assy	
152039	GP1092204	Hot Valve Cartridge Assy	
183237	GP1095915	Handle for Elec Faucets	
183172	GP1105825	Flapper w/ Float Kit	
055368	GP30000	Plug Button Kit	
005943	GP30002	Clockwise Close Valvet	
005944	GP30004	Counter Clockwise Valvet	
055128	GP30090	Niedecken Repair Kit	
055316	GP30100	Plunger Service Kit	
056078	GP30320	Pressure Balance Adapter Kit - Plastic	
055311	GP30413	Lav and Shower Valve	
055353	GP30416	Knob Handle Kit	
072769	GP30420	O-Ring Seal Kit	

Parts (Continued)

Part #	Mfg #	Description	Price
101598	GP41398-CP	Strainer Cup Assy, Chrome	
055340	GP43146	Flair Handle, Clear Acrylic	
055302	GP500520	Pressure Balancing Unit	
055305	GP51487	Tank Gasket w/Bolts	
055338	GP71969	Valve Mixer Kit	
056122	GP75878	Diverter Assembly	
055332	GP76671	Coralais Valve, CCW Close	
055339	GP76672	Coralais Valve, CW Close	
055319	GP76851	Rite-Temp Mixer & PBU SP Kit	
055293	GP77005-RP	1/2" Close CW Hot Ceramic Valve	
055294	GP77006-RP	1/2" Close CCW Cold Ceramic Valve	
055301	GP77548	Coralais & Fairfax Valve	
121052	GP77759	Shower Mixer Cap Kit	
055351	GP77886	SP Mixer Cap Kit	
056127	GP78205-0	Fairfax 1Hdl Plug Button White	
070270	GP78500	Plunger Kit	
180982	GP83996	Gasket for Select Flush Vlv	
055367	GP85061	Beehive Strainer	
055303	GP88921	Flush Ball Kit	
190060	RGP64512	Hanger (2)	

Repair Parts

* Vibrant Limited Lifetime Warranty

www.plumbsupply.com • Serving our Customers Since 1946 • www.waterconcepts.net

Malco Repair Parts

Hole Cutter Parts Hole Cutter Replacement Part

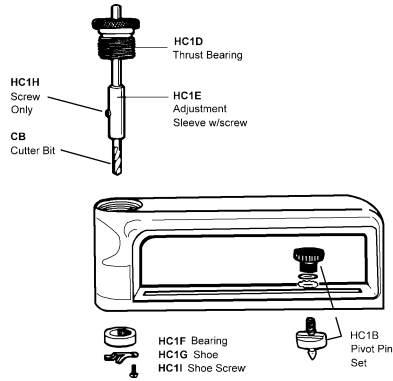

Part #	Mfg #	Description	Price
006379	CB	Malco Bit for HC1 and HC2	
006409	HC1B	Pivot Pinset for HC1	
034909	HC1D	Thrust Bearing w/Adapter	
006410	HC1E	Adjustable Sleeve for HC1	
006411	HC1F	Ball Bearing for HC1	
006412	HC1G	Guide for HC1	
054345	HC1I	Shoe Screw	

Repair Parts

McDonnell & Miller Repair Parts

Replacement Parts

Gasket



Part #	Mfg #	Model #	Used With:	Price
007100	302600	CO-12	42,61,63,64, 65,42S	

Strainer Basket Assembly

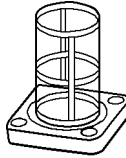

Part #	Mfg #	Model #	Used With:	Price
007104	347100	SA101-38	47, 51, 101	

Repair Parts

Moen Repair Parts

Handle Adapters



100429

Part #	Mfg #	Description	Price
058893	100429	Handle Adapter Kit	

Chateau Knob Handle Kit

- 1-Hdl Tub/Shower



Part #	Mfg #	Description	Price
007370	96797	Clear w/ White & Chrome Insert	

Traditional Handle Kit



Part #	Mfg #	Description	Price
016904	94514	Single-Handle	

Faucet Cartridges

1255 Duralast™ Cartridge



Part #	Mfg #	Description	Price
140023	1255	Duralast™	

1-Hdl Faucet Cartridge

- Brass
- Hot/cold operation
- Includes:
 - Cartridge
 - Retainer Clips
 - Installation tool
 - Installation instructions

1200



1225

Part #	Mfg #	Description	Price
007169	1200B	For 1200 Faucet, Bulk (12/Pk)	
007173	1225B	For All Moen 1-Hdl Faucets Bulk (12/Pk)	

Duralast™ 2-Hdl Faucet Cartridge



Part #	Mfg #	Description	Price
189508	1234	2-Hdl, Duralast™	

2-Hdl Faucet Cartridge

- Brass
- Hot/cold operation



Part #	Mfg #	Description	Price
007172	1224B	For 2-Hdl Moen® Faucets, Bulk (12/Pk)	

Posi-Temp 1-Hdl Faucet Cartridge

- Brass
- Hot/cold operation



Part #	Mfg #	Description	Price
007171	1222B	For 1-Hdl Posi-Temp Faucets, Bulk (12/Pk)	

*Lifeshine® Anti-Tarnish Lifetime Finish

www.waterconcepts.net • Serving our Customers Since 1946 • www.plumbsupply.com

Moen Repair Parts

Commercial Heavy-Duty Posi-Temp Cartridge



Part #	Mfg #	Description	Price
226819	1222HD	Brass Shell	

Commercial Cartridge



Part #	Mfg #	Description	Price
218673	52100	Metering Cartridge	

Commercial 2-Hdl Ceramic Disc Cartridge



Part #	Mfg #	Description	Price
147672	52001	Cold	
147671	52000	Hot	

Commercial 2-Hdl Cartridge

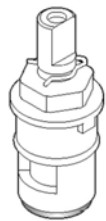

Part #	Mfg #	Description	Price
198776	121551	Cold	

Cartridge



Part #	Mfg #	Description	Price
209555	4000	Replacement	

Commercial 1-Hdl Cartridge

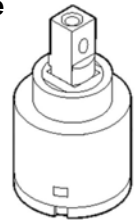

Part #	Mfg #	Description	Price
174468	121620	For Model 8701	

Replacement Cartridge

- For 4999 Roman Tub Valve



Part #	Mfg #	Description	Price
007174	1248	For 4999 Roman Tub Valve	
103661	116719	Replacement Cartridge	

Cartridge Removal Tool

- For 1200, 1225, or 1222 cartridges



Part #	Mfg #	Description	Price
046820	104421	Cartridge Removal Tool	

Cartridge Removal Tool



Part #	Mfg #	Description	Price
020117	14272	Cartridge Retainer Removal Tool	

Repair Parts

*Lifeshine® Anti-Tarnish Lifetime Finish

www.plumbsupply.com • Serving our Customers Since 1946 • www.waterconcepts.net



Moен Repair Parts

Service Parts

Part #	Mfg #	Description	Price
036804	93980	Handle Mechanism Kit f/7400/7600 Kitchen Faucet	
212816	179104	Handle Adapter Kit	
226712	116711	Flow Restrictor Kit	
018319	11985	50/50 Drain Assembly	
019922	12689	Pivot Rod & Clip	
020119	96365	Retainer Clips	
007353	883	Retainer Clip	
021710	96914	Posi-Temp Retainer Clip	
113430	140780	Metal Pop-Up Lav Drain, Chrome	
103739	140780BN	Metal Pop-Up Lav Drain, Brushed Nickel	
103122	140780ORB	Metal Pop-Up Lav Drain, Oil Rubbed Bronze	
226575	131553BN	Pop-Up Lav Drain, Brushed Nickel	
021437	96497	Waste Assembly, Chrome	
023012	12314	Plug & Cap	
007200	1920	Valve Cover Plate, Chrome	
078637	101663BN	Drain Cover, Brushed Nickel	
101250	101663ORB	Drain Cover, Oil Rubbed Bronze	
035758	1423	Balancing Spool	
201600	52012	Commercial Vacuum Breaker	
140881	588	Donner Commercial C-Clamp	
007391	97557	Monticello Handle Inserts, Chrome	
007382	97462	Monticello Handle Insert, Chrome	
007362	91751	Knob Insert Kit, Chateau	
044029	96782	Chateau Handle Kit	
007369	96791	Chateau Handle Kit	
007360	91192	Diverter Kit for 1Hdl Kit Fct	
007368	96790	Handle Kit, Chrome	
091499	116653	Handle Adapter Kit	
020189	98039	Handle Kit, Acrylic	
118478	136103C	Kitchen Spray and Hose	
144317	106378	Asceri Stem Extension Kit	
019330	97556	Monticello Handle Adapter Kit	
020032	95606	Monticello Handle Hub Kit	
032729	95602	Monticello Handle Hub Kit	
007389	97479	Monticello Stem Extension Kit	
007372	97344	Monticello Stem Extension Kit	
124051	145058	Adapter Kit	
026035	14732	Handle Kit, Chrome	
103271	100818	Extension Kit	
097867	114299	Hose Kit	
045742	12318	Check Stop	
196066	94770	Plug Button & Set Screw	
124741	100112	Monticello aerator, 2.2 gpm	

Service Parts (Continued)

Part #	Mfg #	Description	Price
007201	20200	Aerator	
179477	150259	Hose Kit	
114856	A750	Slide Bars	
162734	104524	Manual Override Button - Flush Valve	
031502	101099	Handle Connector, Spacer, Screw & Washer for Loop Hdl Kitchens	
043598	101310	Chateau Lever Handle Kit	
165290	104401	Multi-Unit AC Power Adapter	
109518	9601	Choiceflo Replacement Filter 9600/9602/9500/9502	
071412	100021	Chateau Handle Cap, Chrome	
071756	100710	Posi-Temp T&S Acrylic Handle	
017776	14699	Retainer Pivot Nut, 1Hdl Kit Fct	
022554	15528	Escutcheon Screws	
007163	10089	Legend & Chateau 1Hd T&S Knob Handle Stop Tube	
089374	100657	Handle Kit, Chrome	
186665	221672	Weymouth Hot & Cold Handle Caps, Chrome	
225625	221672BN	Weymouth Hot & Cold Handle Caps, Brushed Nickel	
017751	13463	Chateau Tub Fct Stem Extension	
007371	96884	Handle Insert Kit	
215829	155655	Screen Filter	
224150	155658	Hardware Kit	
146281	10116	Plug Button Kit, Chrome	
216901	104444	Commercial Supply Line	
007168	1198	Push Button Diverter	
032769	13462	Handle Adapter Kit	
224151	155651	Hardware Kit	
025797	13769	Chateau Escutcheon, Chrome	
017752	13774	Wall Tube, Chrome	
121811	163WR	Escutcheon Screws, Wrought Iron	
105725	128284	Twin Elbow	
216105	131109	Handle Kit, Chrome	
212814	179103	Handle Adapter Kit	
185665	AT2099ORB	T/S Accent Kit, Oil Rubbed Bronze	
201230	143530	Diverter Plug	
195900	A714	Vacuum Breaker, Chrome	
121669	96945	Handle Extension Kit	
211430	140710	Cartridge Nut	

*Lifeshine® Anti-Tarnish Lifetime Finish

www.waterconcepts.net • Serving our Customers Since 1946 • www.plumbsupply.com

Moen Repair Parts

Spout O-Ring Kit



Part #	Mfg #	Description	Price
007167	117	Bulk	
215830	155654	O-Ring Kit	
201190	146789	O-Ring Kit	
020120	96778	O-Ring Kit	

Aerator

- 2.2 gpm
- Male thread



Part #	Mfg #	Description	Price
007264	3919	2.2gpm Male Thread	

3924 Aerator



Part #	Mfg #	Description	Price
007265	3924	Chrome	

Repair Parts

*Lifeshine® Anti-Tarnish Lifetime Finish

www.plumbsupply.com • Serving our Customers Since 1946 • www.waterconcepts.net

EL Mustee Repair Parts

Shower Stall Parts



Part #	Mfg #	Description	Price
007562	80.438	Handle Screw	
007563	80.440	Stem & Bonnet Assembly	
007564	80.441	Renu Seat - Brass	
034313	80.449	Crystal Handle	
034311	80.450	Hot Index Plug	
034312	80.451	Cold Index Plug	
034544	80.454	Stem for 80-400 Shower Valve	
034545	80.455	Renu Seat - Brass	
007569	82.400	1-1/2" PVC Shower Drain	

Repair Parts

Navien Repair Parts

Parts & Accessories



O-Ring



Packing O-Ring



Pressure Flow Sensor

Part #	Mfg #	Description	Price
149791	2505401A	CPVC Vent Collar	
127478	30000663A	Air Pressure Sensor, NASS9EX00009	
135435	30000669A	Air Pressure Sensor, NASS9EXOS001	
126626	30004802C	Water Flow Sensor, AASS9EXFS003C	
136813	BH0914002B	Motorized 2-Way Valve	
126593	BH2507399A	3-Way Valve, A-Type Copper	
136814	BH1201041D	Ignition Transformer with Wire	
126589	BH1205008A	Transformer	
126623	BH1303013A	Inlet Filter	
126630	BH1403081A	Thermostat (Black Wire)	
134822	BH2101273B	Remote Wire	
126587	BH2124012A	Fuse, 125V, 5A	
126586	BH2203001A	Black Tube	
126628	BH2406032A	Packing O-Ring, 20"Dia x 2.5"T	
126599	BH2421008A	O-Ring, Gas Black, 19.8"Dia x 2.4"T	
126653	BH2421997A	Black O-Ring	
126602	BH2423052A	O-Ring, White or Blue, 15.8"Dia x 2.4"T	
126600	BH2423053A	O-Ring, Red, 17.8"Dia x 2.4"T	
126654	BH2423055A	O-Ring, Black, 17.5"Dia x 2.7"T	
126603	BH2423064A	O-Ring, Red Water, 15.8"Dia x 2.7"T	
126597	PH1062017A	Back-Up O-Ring	
126588	BH2501679A	NG Flame Rod	
136815	BH2507507A	Water Pipe Adapter, Black	
127841	BCRA1129	Ready-Link Connection Cable	
136820	NAPU9GLPCT01	NP Series Circulation Pump	
136821	NARC1GSR007	Remote Control	
126591	NASS9EXGPS01	Gas Pressure Flow Sensor	
126625	NCVM9EX00005	Flow Adjustment Valve	
126595	PAPCT1W0725	058 Pump	
126632	PH1799013A	Pipe Adapter	

Repair Parts

Reznor Repair Parts

Limit Controls

Part #	Mfg #	Description	Price
008477	45602	(180°F) White Auto Limit Control	
008480	50417	(125°F) White Auto Limit Control	
008481	50418	(145°F) Blue Auto Limit Control	
008497	82091	(160°F) Red Auto Limit Control	
008498	82414	(306°F) ECO Energy Cut-Out Limit Control	
008500	85449	(200°F) Yellow Auto Limit Control	
008524	96512	(220°F) High Temperature Limit Control	
008458	123974	(135°F) Fan Control	
008459	123976	(135°F) Fan Control	
027171	131449	(228°F) ECO Energy Cut-Out Limit Control	
030936	147676	(150°F) Fan Control w/Bracket for XL/CXL/EEXL/CEEXL 30 - 400	
066266	196950	Flame Rollout Manual Reset Limit Switch	
083879	209184	Fan Control Replacement Kit	

Gas Conversion Kits



Part #	Mfg #	Description	Price
008536	99244	LP Conversion Kit for F/FE-50	
153551	269835	LP Conversion Kit for Model UDAP/UDAS Size 30, 45	
153552	269836	LP Conversion Kit for Model UDAP/UDAS Size 60, 75	
153554	269838	LP Conversion Kit for Model UDAP/UDAS Size 150, 175	
153553	269839	LP Conversion Kit for Model UDAP/UDAS Size 200, 250	
066004	201732	LP Conversion Kit for Model UDAP/UDAS Size 300, 400	
073497	205515	LP Conversion Kit	
073498	205516	LP Conversion Kit	
127038	257472	Ignition Conversion Kit (Replaces 97782)	
127637	257473	LP Conversion Kit, Old #G77	

Gas Valves

Part #	Mfg #	Description	Price
008518	96300	1/2" Natural Gas Valve (W/R #36C03-211) Replacement	
008519	96307	1/2" Natural Gas Valve Replacement	
022074	121599	1/2" Single Stage Valve (VR8304M2816)	
027313	147830	1/2" Single Stage Natural Gas Valve (VR8205M1130)	
082010	204301	1/2" Single Stage Natural Gas Valve (VR8205M2955)	
091161	208920	1/2" Single Stage Natural Gas Valve w/Standing Pilot (VR8200M7005)	

Reznor Repair Parts

Motors

Part #	Mfg #	Description	Price
008476	45331	1/40 hp Motor	
027821	102380	1/8 hp Motor	
008485	61069	1/20 hp Motor	
008508	95547	1/20 hp Motor for Model F 130 & 200	
008509	95548	1/30 hp Motor	
008502	88781	1/6 hp Motor	
066238	196241	Fan Motor for UDAP 45 - 60	
066252	196242	Fan Motor for UDAP 75	
066267	196243	Fan Motor for UDAP 100	
066314	196247	115V Fan Motor for UDAP and UDAS 300 - 400	
008507	95546	Fan Motor	
008515	96287	Fan Motor	
008516	96288	1/15 hp Fan Motor	
102121	147571	Fan Motor	
008514	96018	Venter Motor Assembly	
027692	97727	Venter Motor and Wheel Assembly	
037534	97730	115V Venter Motor and Wheel Assembly	
100298	131410	115V Venter Motor with Capacitor	
170634	214067	115V Venter Motor less Capacitor	
033127	148055	115V Venter Blower Motor	
066281	196036	115V Venter Motor for UDAP and UDAS 150 - 175	
130576	196037	115V Venter Motor for UDAP and UDAS 200 - 250	
109924	214066	115V Venter Motor for VR 175/200 with Capacitor	
144784	217032	120V, 60Hz Venter Motor for UDAP (Replaces 175273)	
139008	260422	115V Venter Motor	

Pilots & Components

Part #	Mfg #	Description	Price
008486	61145	Natural Gas Pilot Assy w/ Orifice, High Tension Lead & Flame Probe; less Pilot Tubing & Flame Sensor	
008523	96360	Natural Gas Pilot Assembly with Orifice, Pilot Tubing, & Thermocouple; (for All F Models)	
020439	110853	Natural Gas Spark Pilot Assembly	
066224	175272	DSI Electrode Assembly	

Pressure Switches

Part #	Mfg #	Description	Price
066242	196388	High Altitude Pressure Switch for UDAP-CV, UDAS 100	
062419	196653	Pressure Switch	
091540	205442	0.20"wc Low Speed White Label Pressure Switch	
091216	205443	Low Speed Yellow Label Pressure Switch	
066288	201158	1.10"wc Pressure Switch	

Repair Parts

Reznor Repair Parts

Transformers

Part #	Mfg #	Description	Price
008461	131988	120/24V Transformer	
008462	132204	120/24V, 20VA Transformer	
091211	175265	115V, 30VA Control Transformer	
066225	194808	Transformer, 40VA	

Vent Caps



Part #	Mfg #	Description	Price
067827	111849	5" Vent Cap for UDAP 150 - 250	

Parts

Part #	Mfg #	Description	Price
022890	43425	Inducer Blower Wheel (AD326-215-101-2)	
008527	97534	Natural Gas Pilot Assembly	
020436	97535	LP Pilot Assembly with Flame Sensor	
020437	97572	Compression Nut	
020449	97724	Venter Wheel FE130-400	
021456	97725	Venter Wheel FE25-100	
021538	18549	RBM Relay All FE Models	
008534	98697	Flame Rod	
021502	116019	37-1/8" Tubular Section for TR & TR-H Models	
060039	116045	Burner On Light	
091538	120545	Venter Wheel	
020765	121275	Block Vent Switch	
026634	132007	Venter Wheel	
061819	135979	Venter Wheel	
027310	147165	Flame Sensor	
027317	148085	18" Ignition Cable	
066231	195036	Venter Wheel Assembly	
066222	195265	Control Board	
066223	195292	Flame Sensor	
066237	196949	Flame Rollout	
084139	197205	High Altitude Conversion Kit	
067749	201685	3 amp Fuse	
086607	204611	DSI Electrode Assembly for Model VR	
073531	204955	DSI Ignition Control	
123105	257531	UDAP Circuit Board	
133894	259521	Time Delay Relay Kit	
139262	262971	Time Delay Relay Kit	
036781	CC2	Vertical Vent Terminal/Combustion Air Inlet Assembly through Roof for UEAS Model	

Repair Parts

Rinnai Repair Parts

Tankless Water Heater Parts & Accessories
PC Board

Part #	Mfg #	Description	Price
074884	U245-500	PC Board for 2532FFU	
141779	U245-500F	PC Board for REU-2532-FFU	

Water Filter Assembly

- O-Ring, plug & filter

Part #	Mfg #	For Use with	Price
098970	H98-510-S	Continuum 2424	

Parts
Replacement Parts



Pipe Clamp



80400013, 80400014

Part #	Mfg #	Description	Price
114108	104000021	Gas Valve Kit for R75LS & R94LS	
136286	806000019	Gas Valve	
136284	808000020	Draft Inducer	
142945	104000181	Heat Exchanger	
135781	804000013	3-Way Diverter Valve for Q85S & Q130S	
135777	804000014	3-Way Diverter Valve for Q175S & Q205S	
113465	104000011	Electrode Rod Kit	
114110	104000023	Electrode Kit for R75LS & R94LS	
104584	EI-189	Igniter/Sparker	
108019	REU-EZC-1US	EZ Connect Cable (for the R94LS, R75LS, R50LSi, and R98/3237FFU/W Units Only)	
139993	REU-MSB-M	Multi Unit Tankless Water Heater Manifold Electronic Control Kit	
139994	REU-MSB-C1	Cable Connect Ultra/Condensing and Luxury Series	
139995	REU-MSB-C2	Cable for Connecting MSB-M Control Units	
135488	105000068	Igniter/Sparker	
136287	805000026	5 Amp Fuse, 3-Pk	
114112	104000022	Flame Rod Kit for R75LS & R94LS	
136285	805000036	Ignition Electrode and Gasket	
108197	AH66-398-2	Electrode Gasket	
145426	805000033	High Limit Switch	
120655	104000017	Water Flow Servo and Sensor	
145430	805000032	Return & DHW Sensor	
145429	805000034	Water Pressure Sensor	
145428	805000035	Supply Sensor	
145423	805000040	Flue Gas Sensor with Cable	
145427	805000047	Outdoor Reset Sensor	
115221	104000018	Water Flow Control Assembly Kit for V2532	
114107	104000028	Water Flow Control Assembly Kit for R94LSi & R94LSe	
114116	104000029	Water Flow Control Assembly Kit for R75LSi & R75LSe	

Repair Parts

Rinnai Repair Parts

Parts (Continued)
Replacement Parts

Part #	Mfg #	Description	Price
150390	104000163	Water Servo Valve	
115250	104000019	Fan Assembly Kit for V2532FFU, V2520	
142946	104000198	Bypass-Servo Assembly	
065656	169044	Pipe Clamp 2402	
136282	805000024	MCBA Control Unit	
143828	805000028	MCBA Display	
145424	807000040	120V Pump For Q85 & Q130	
145425	807000041	120V Pump For Q175 & Q205	
114472	AU183-562	Fan Connecting Packing	

Repair Parts

Ruud Water Heater Repair Parts

Water Heater Parts



RTG-20040

Part #	Mfg #	Description	Price
109636	RTG-20040	Ez-Link Cable Connects (2) Tankless Gas Water Heaters to Operate As One Unit	
074314	AP12938	42" Aluminum Anode Rod	
063009	SP11309C	44" Resistor Magnesium Anode Rod	
091619	SP8371B	52" Anode Rod w/Resistor Flex	
063007	SP11248R	Dip Tube	
113598	SP6830	Adapt-O-Flange	

Blower Assembly

Part #	Mfg #	Description	Price
100247	AP13416	Blower Assembly for 40/50 gal PowerVent Units	
133976	SP13605	Blower Assembly for 40/50 gal PowerVent Units	

Control

Part #	Mfg #	Description	Price
073493	AP12419	199,000 BTUH Main Control PC Board	
137362	AP14672	LP Electronic Gas Control	
113853	SP20161A	Natural Gas Wiper Control & Gas Valve Assembly for PowerVent 2	
113854	SP20162A	LP Gas Wiper Control & Gas Valve Assembly for PowerVent 2	
120504	SP20170A	Natural Gas FV Wiper Control & Gas Valve Assembly	
120505	SP20170B	Natural Gas FV Wiper Control & Gas Valve Assembly	
101157	SP20123B	FV Wiper Electronics	

OEM Screw-In Elements - 1-1/2" Copper

- Specifically designed for Marathon and Eclipse Water Heaters
- Includes gasket
- Low Watt Density



Part #	Mfg #	Description	Price
116994	SP10698MH	240V/4500W, 12.33" Length	

OEM Screw-In Elements - 1-1/2" Titanium

- Specifically designed for Marathon and Eclipse Water Heaters
- Includes gasket
- Low Watt Density



Part #	Mfg #	Description	Price
141163	SP213790	240V/4500W, 14" Length	
132919	SP213670	240V/4500W, 16.5" Length	

Electric Water Heater Elements Copper - R-Tech

- Screw-in elements - 1 Inch
-Fits most water heaters with 1" NPSM threads
- R-Tech - Features a patented resistored design that increased the life of both the element and water heater tank
- Watt Density Guide - lower watt density means the element stays cooler and will last longer
-LWD: low watt density (100 watts/in² or less)
-MWD: medium watt density (101-150 watts/in²)
-HWD: high watt density (over 150 watts/in²)



Part #	Mfg #	Description	Price
126122	SP10552JH	240V/3000W, 10-5/8" HWD	
063001	SP10552KL	240V/3500W, 13-3/8" LWD	
078390	SP10552ML	240V/4500W, 13-3/4" LWD	
063002	SP10552MH	240V/4500W, 13-5/8" HWD	
063000	SP10552PH	240V/5500W, 13-1/2" HWD	
076289	SP10552QH	240V/6000W, 11-3/4" HWD	
062998	SP10874FH	120V/1500W, 7-11/16" HWD	
062997	SP10874GH	120V/2000W, 7-11/16" HWD	
062996	SP10874HH	120V/2500W, 9-7/16" HWD	

Repair Parts

Ruud Water Heater Repair Parts

Electric Water Heater Elements Stainless Steel - R-Tech

- Screw-in elements - 1 Inch
-Fits most water heaters with 1" NPSM threads
- R-Tech - Features a patented resistored design that increased the life of both the element and water heater tank
- Watt Density Guide - lower watt density means the element stays cooler and will last longer
-LWD: low watt density (100 watts/in2 or less)
-MWD: medium watt density (101-150 watts/in2)
-HWD: high watt density (over 150 watts/in2)



Part #	Mfg #	Description	Price
063479	SP10867LL	208V/4000W, 10.08", LWD	
063481	SP10867NL	208V/5000W, 19.25", LWD	
063486	SP10869ML	240V/4500W, 15-1/2" LWD	
073434	SP10869MM	240V/4500W, 13-1/2" MWD	
063480	SP10867ML	208V/4500W, 17.58" LWD	
063482	SP10867QL	208V/6000W, 19-1/4" LWD	
063488	SP10869QL	240V/6000W, 19-1/8" LWD	
063494	SP10870NL	480V/5000W 19.28", LWD	
063493	SP10870ML	480V/4500W 17.63" LWD	
063495	SP10870QL	480V/6000W 19.21" LWD	

Heating Element Wrench

- Allows use of screwdriver for additional leverage



Part #	Mfg #	Description	Price
063006	SP35871AB	Fits 1-1/2" Hex	
169225	PT49057	Fits 1-1/2" & 1-7/8" Hex	

Igniter

Part #	Mfg #	Description	Price
063860	SP10972	Hot Surface Igniter	
108321	SP12143	Igniter for Advantage Plus Comm Water Heaters	
064395	SP12560B	Spark Igniter & Pilot Assembly (LP) for PowerVent 2	
064396	SP12560C	Spark Igniter & Pilot Assembly (LP) for PowerVent 2	
064393	SP12562	High Performance Blower Assembly for PowerVent 2	
100162	SP13447B	Flammable Vapor Sensor/FV Wiper Replacement Kit	
129324	SP14218A	Igniter for PowerVent Units	

Water Heater Parts (Continued)

Igniter

Part #	Mfg #	Description	Price
109619	SP14218B	Igniter for PowerVent Units	
146883	SP20307	Piezo Igniter	

Pilot Assembly

Part #	Mfg #	Description	Price
104045	SP13418	Pilot Assembly - Natural Gas	
117788	SP13422	Pilot Assembly - Natural Gas	
177859	SP13884A	Pilot Tube Assembly Kit	
170382	SP20305A	Pilot Assembly - Natural Gas	

Switch

Part #	Mfg #	Description	Price
128923	AP12767	On/Off Switch	
063577	SP11875	Vacuum Switch	
065175	SP12766	Pressure Switch for PowerVent 2	
101155	SP20116	Vacuum Switch for PowerVent	
140234	SP20312	Pressure Switch for PowerVent	

Thermostat

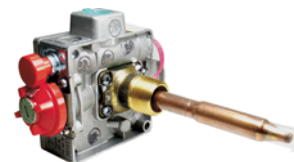

Part #	Mfg #	Description	Price
063014	SP12258P	Thermostat for 40 & 50 gal VR Models - LP Gas	
063576	SP12390	PowerVent Therm-O-Disc Thermostat	
131662	SP20164	Gas Control Thermostat, Natural Gas for Use with 2LAC9	

Gas Control (Thermostat) - LP



Part #	Mfg #	Description	Price
156423	SP20304B	LP Gas Control	

Ruud Water Heater Repair Parts

Gas Control Assembly

- Rheem/Ruud replacement gas control thermostat
- For PowerVent Models only



Part #	Mfg #	Description	Price
159000	SP20231	6"x6"x4" Replacement Gas Control for PowerVent Models	

Gas Control (Thermostat) - NG



Part #	Mfg #	Description	Price
180874	AP14270C	Natural Gas Control	

2-Pole High Limit - Normally closed Thermostat Contacts (TOD)

- Upper Thermostat in residential electric water heaters
- With Simultaneous design:
-Both elements are on at the same time



Part #	Mfg #	Description	Price
063011	SP11699	240V Single Element Thermostat	

2-Pole High Limit - Normally Open & Normally Closed Thermostat CContacts (TOD)

- Upper thermostat for residential electric water heaters
- Non-Simultaneous element operation
- 59T/66T Series



Part #	Mfg #	Description	Price
063013	SP11698	Upper Thermostat, 90° to 150° Adjustment Range	
135205	SP210245	Upper Thermostat, 80° to 140° Adjustment Range	

1-Pole High Limit - Normal Closed Thermostat Contacts (TOD)

- Commonly used for 120V residential water heaters with only one element
- 59T/66T Series



Part #	Mfg #	Description	Price
063004	SP11700	Upper Thermostat, 90° to 150° Adjustment Range	

Electric Thermostats w/o High Limit Control (TOD)

- Used as the lower Thermostat in residential electric water heaters
- 59T Series



Part #	Mfg #	Description	Price
063012	SP11695	Lower Thermostat, 90° to 150° Adjustment Range	
141066	SP210239	Lower Thermostat, 90° to 150° Adjustment Range	
111142	SP310020	Lower Thermostat, 110° to 170° Adjustment Range	

Robertshaw Thermostat

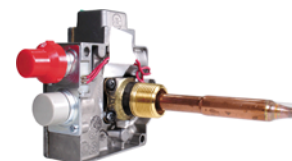

Part #	Mfg #	Description	Price
063016	SP12258B	LP Gas, 57° - 160° Control Valve with LHMain Burner	

Thermostat Shank



Part #	Mfg #	Description	Price
147598	AP14696A	Thermostat Shank - 1.926	
139027	AP14696B	Thermostat Shank - 2.870 PV	



Ruud Water Heater Repair Parts

Thermocouple



Part #	Mfg #	Description	Price
063005	SP6379R	24" Thermocouple	

Valve

Part #	Mfg #	Description	Price
076815	AP12575B-1	3/4" T&P Valve for FVIR Long Shaft	
063423	SP11652B	Natural Gas Valve	
109615	SP13845A	Natural Gas Intelli-Vent Valve for PowerVent Units	
109616	SP13845B	Natural Gas Intelli-Vent Valve for PowerVent Units	
109617	SP13846A	LP Gas Intelli-Vent Valve for PowerVent Units	
109618	SP13846B	LP Gas Intelli-Vent Valve for PowerVent Units	
127436	SP20167C	LP Gas Valve and Thermostat	
129691	SP623336	Vacuum Relief Valve Assembly for Marathon Water Heaters	
133902	SP20171A	Gas Control Thermostat Kit	
159270	SP20303A	Nat Gas Control Thermostat Kit	

Vent Damper

Part #	Mfg #	Description	Price
108929	AP13142	Vent Hood Damper Assembly	
065184	AP13143-1	Vent Hood Damper Assembly	

Warranty Upgrade

Part #	Mfg #	Description	Price
078740	SP20079	Protection Plus 4-Year Kit	

Flammable Vapor Ignition Resistant (FVIR) Parts

Robertshaw Part



SP20064

Part #	Mfg #	Description	Price
073471	SP20064	Thermocouple Kit	
073470	SP20065	Pilot Assembly - Natural Gas	
082616	SP20075	Pilot Assembly - Natural Gas	
097155	SP20055	Piezo & Pilot Assembly Kit	

White-Rodgers Part

Part #	Mfg #	Description	Price
109602	SP14270G	Gas Valve - Natural Gas	
109603	SP14270H	Gas Valve - Natural Gas	
109607	SP14269A	Gas Valve - LP Gas	
109609	SP14269E	Gas Valve - LP Gas	
109611	SP20127	Pilot Assembly Kit - Natural Gas	
109612	SP20128	Pilot Assembly Kit - LP Gas	

Common Service Part

Part #	Mfg #	Description	Price
082082	SP12112G	Electric Drain Valve	
073962	SP12112S	Brass Drain Valve	
082825	SP8346	Watts 100XL, 3/4", 150 psi, 100,000 BTU Temperature & Pressure Relief Valve	
073469	SP20063	Gasket Kit	

Commercial Water Heater Parts

Part #	Mfg #	Description	Price
069329	AP12231B-1	3/4" NPT Brass Drain Valve	
144116	AP9013D	130 to 199K Temperature and Pressure Relief Valve	
144117	AP9012B	250 to 400K Temperature and Pressure Relief Valve	
065179	SP10963D	Natural Gas Valve	
073487	SP12145	Gas Valve	
073418	AP12015-1	Thermostat and High Limit	

Repair Parts



Ruud Water Heater Repair Parts

Commercial Water Heater Parts (Continued)

Part #	Mfg #	Description	Price
082771	AP12841	3-Pole Contractor	
144111	AP14074-3	Temperature Sensor	
144119	AP14092-2	GHE Main Control Harness	
144120	AP14157-3	GHE Blower Control Harness	
144121	AP14158-6	GHE Main Power Harness	
145841	AP14159-5	GHE Gas Valve Harness	
144112	AP14280-1	Exhaust Temperature Flue Sensor	
144115	AP14685-2	Condensate Trap	
144118	AP14758	Display Jumper Harness	
144128	AP14859	Diffuser Nipple	
144124	AP15261	Ground Wire Harness	
144123	AP15294-4	GHE Igniter Cable Harness	
143193	RTG20224A	Commercial Upgrade Chip for RTGH-95DVN Natural Gas	
131528	RTG20216A	Commercial Conversion Kit for RTG-84DVN	
075285	SP12142	ECO/Temperature Probe	
073486	SP12144	Flame Rectification Probe	
073495	SP12189	Combustion Blower	
148468	SP15138	Burner Mounting Flange Gasket	
144109	SP20259	Flame Sensor Rod Kit	
063119	SP5886	Hand Hole Gasket	
073485	SP12140	Pressure Switch	
065181	SP10764B	Pilot Assembly for Natural Gas Units	
073488	SP12136	130,000 BTUH Main Control PC Board	
073489	SP12137	160,000 BTUH Main Control PC Board	
073490	SP12186	199,000 BTUH Main Control PC Board	
065180	SP11798B	High Limit Thermostat	
065178	SP12234B	Commercial Light Duty Gas Thermostat	
084096	SP8293	Therm-O-Disc Upper Thermostat	
073160	SP8295	Therm-O-Disc Lower Thermostat	
065182	SP10763B(C)	Ignition Control	
093329	SP8828D	Ignition Cable	
131606	RTG20210	Horizontal Vent Termination Kit	

Repair Parts

Schwank Repair Parts

Tube Heater Parts

Part #	Mfg #	Description	Price
129015	JA-0528-XX	4" Horizontal Flue Vent Terminal	
130962	JA-0568-XX	24VAC DSI Control	
134135	JA-0571-KT	DSI Tube Heater Igniter & Gasket	
129442	JA-0775-XX	120/24V, 20VA Transformer	
129441	JL-0703-AA	LP Gas Valve	
147558	JL-0771-XX	1/2" x 24" SS Flexible Gas Connector	
147560	JL-0771-YY	3/4" x 36" SS Flexible Gas Connector	
129016	JL-0772-XX	Dual Scale Line Voltage Thermostat	
129010	JL-0798-SH	1-7/8" 'S' Hook - 25/Pk	
136512	JL-0800-SH	2" Safety Snap Hook - 24/Pk	
129009	JL-0798-JC	50' Box of #8 Jack Chain	
136510	JL-0800-XX	200' Roll of #2 Lion Chain	
130761	JM-0303-KT	24V Transformer/Relay Kit	
129018	JS-0508-SM	90° Aluminum Steel Elbow Kit	
129962	JS-0532-SE	4" Fresh Air Intake Adapter	
129012	JS-0532-VC	4" Outside Air Intake Wall Vent Hood with Birdscreen	
129452	JS-0568-KT	24V Thermostat Control Relay Kit	
129447	JS-0576-AA	Air Proving Switch - .85" WC	
129444	JS-0576-XX	Air Proving Switch - .48" WC	
129445	JS-0576-YY	Air Proving Switch - .30" WC	
129450	JS-0577-SS	Blocked Flue Switch - .58" WC	
129448	JS-0577-ZZ	Blocked Flue Switch - 1.41" WC	
129449	JS-0577-YY	Blocked Flue Switch - .90" WC	
134136	JS-0518-XX	24" High Voltage Ignition Cable	

Repair Parts

Sloan Repair Parts

Manual Flushometer Parts

Royal Flushometer Parts

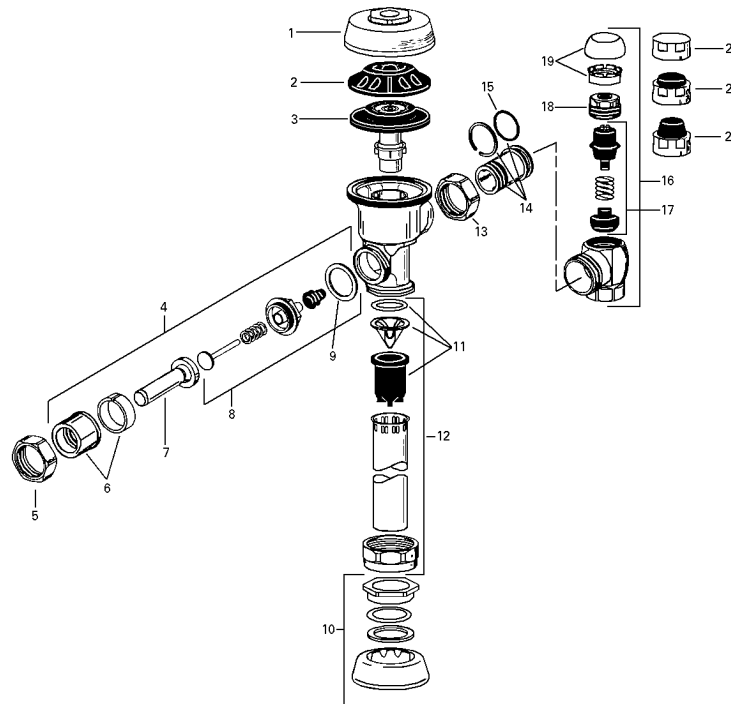

Part #	Mfg #	Model	Ref	Description	Price
083761	3301503	A-1042-A		Repair Kit Royal 1.0 gpf Dual Filter Diaphragm Kit	
010089	0301075	A-11	2	Inside Cover	
036284	3301070	A-1101-A	3-5	Rebuild Kit 1.6 gpf - Closet Exposed	
036283	3301071	A-1102-A	3-6	Rebuild Kit 3.5 gpf - Closet Exposed	
036282	3301074	A-1107-A	3-9	Rebuild Kit 1.0 gpf - Urinal Exposed	
036291	3301075	A-1108-A	3-10	Rebuild Kit 1.5 gpf - Urinal Exposed	
010092	5301188	A-156-A	5	Diaphragm	
010097	5301139	A-31	9	Handle Gasket	
021329	0301082	A-6	5	Handle Coupling, CP	
010107	0301168	A-71	2	Inside Cover	
010108	0301172	A-72	1	Outside Cover, CP	
010112	5302279	B-32-A	4-2	Handle Assembly	
036285	3302306	B-51-A	8	Handle Repair Kit	
010119	0302390	B-73-A	4-1	Handle Assembly	
010137	0306146	F-5-AT	10-3	1-1/2" Spud Coupling, CP	
010138	0306140	F-5-AU	10-2	1-1/4" Spud Coupling, CP	
010136	0306125	F-5-AW	10-1	3/4" Spud Coupling, CP	
020801	3308790	H-1009-A	19-2	3/4" Vandal Resistant Stop Cap For H-700-A	
010148	3308853	H-541-ASD	17-1	1" Screwdriver Stop Repair Kit	
010149	3308856	H-543-ASD	17-2	3/4" Screwdriver Stop Repair Kit	
010150	0308801	H-551-A	14	2-1/16" Tail Assembly, CP	
010152	5308696	H-553	15	O-Ring	
010154	0308848	H-582	20-2	3/4" Cap, CP	

Repair Parts

Sloan Repair Parts

Manual Flushometer Parts (Continued)

Royal Flushometer Parts

Part #	Mfg #	Model	Ref	Description	Price
028922	3308386	H-700-A	16-2	1" Adjustable Screwdriver Stop w/Vandal Resistant Cap #19-2	
036290	3393004	V-600-AA	12-1	3/4" x 9" Vacuum Breaker, CP	
036288	3393006	V-600-AA	12-1	1-1/4" x 9" Vacuum Breaker, CP	
036287	3393007	V-600-AA	12-3	1-1/2" x 9" Vacuum Breaker, CP	
036286	3323182	V-651-A	11	Vacuum Breaker Repair Kit	

Regal Flushometer Parts

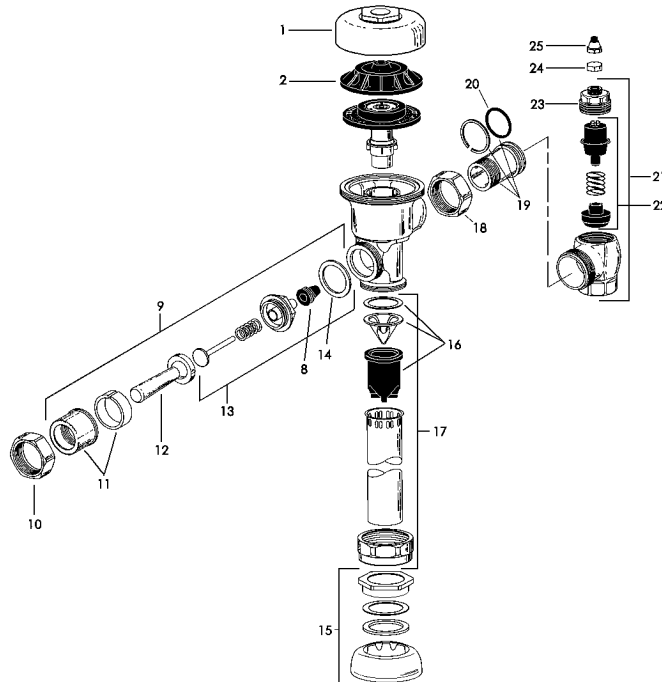

Repair Parts

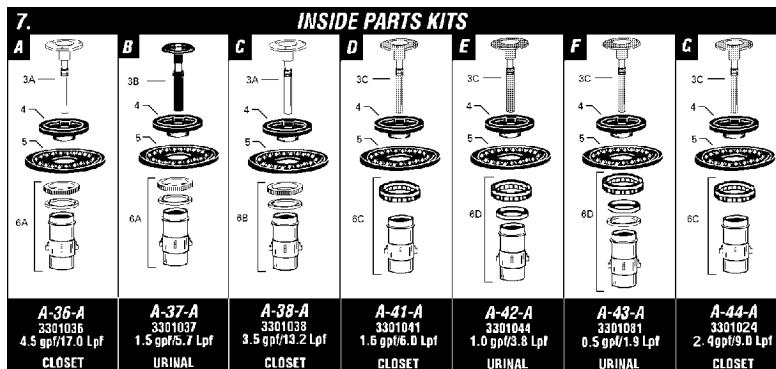

Part #	Mfg #	Model	Ref	Description	Price
010091	5301111	A-15-A	4	Molded Disc	
010093	5301189	A-156-AA	4,5,8,14	Diaphragm Repair	
010094	5301236	A-163-A	6A	Guide Assembly for 4.5 gpf Closet & 1.5 gpf Urinal	

Sloan Repair Parts

Manual Flushometer Parts (Continued) Regal Flushometer Parts

Part #	Mfg #	Model	Ref	Description	Price
010095	5301058	A-19-AC	3A	Relief Valve Closet	
010096	5301059	A-19-AU	3B	Relief Valve Urinal	
010098	3301036	A-36-A	7A	4.5 gpf Closet Repair Kit	
010099	3301037	A-37-A	7B	1.5 gpf Urinal Repair Kit	
010100	3301038	A-38-A	7C	3.5 gpf Water Saver Repair Kit	
010101	3301041	A-41-A	7D	1.6 gpf Closet Repair Kit LC	
010102	3301044	A-42-A	7E	1.0 gpf Urinal Kit LC	
010113	5302297	B-39	8	Seal	
010115	5302305	B-50-A	13	Handle Repair Kit	
010141	5308156	H-37	24	Cap CP	
010176	5323005	V-500-AA	17-1	3/4" x 9" Vacuum Breaker CP	
010182	5323006	V-500-AA	17-2	1-1/4" x 9" Vacuum Breaker CP	
010178	5323007	V-500-AA	17-3	1-1/2" x 9" Vacuum Breaker CP	

Piston Operated Flushometers

GEM 2® Piston Operated Flushometers

- Fixed volume piston with filtered O-ring by-pass
- ADA Compliant metal oscillating handle
- Vandal-resistant stop cap
- Adjustable tailpiece
- Vacuum breaker flush connection
- High copper, low zinc brass castings for dezincification resistance
- Non-hold-open handle and no external volume adjustment to ensure water conservation
- Handle packing, stop seat and vacuum breaker molded from PERMEX™ rubber compound for chloramine resistance



GEM 2 Repair Kit

Part #	Mfg #	Model	Description	Price
112656	5307074	G-50-A	Handle Repair Kit, 6/Pk	

Sloan Repair Parts

**Sensor Operated Flushometer Parts
OptimaPlus® Flushometer Parts**

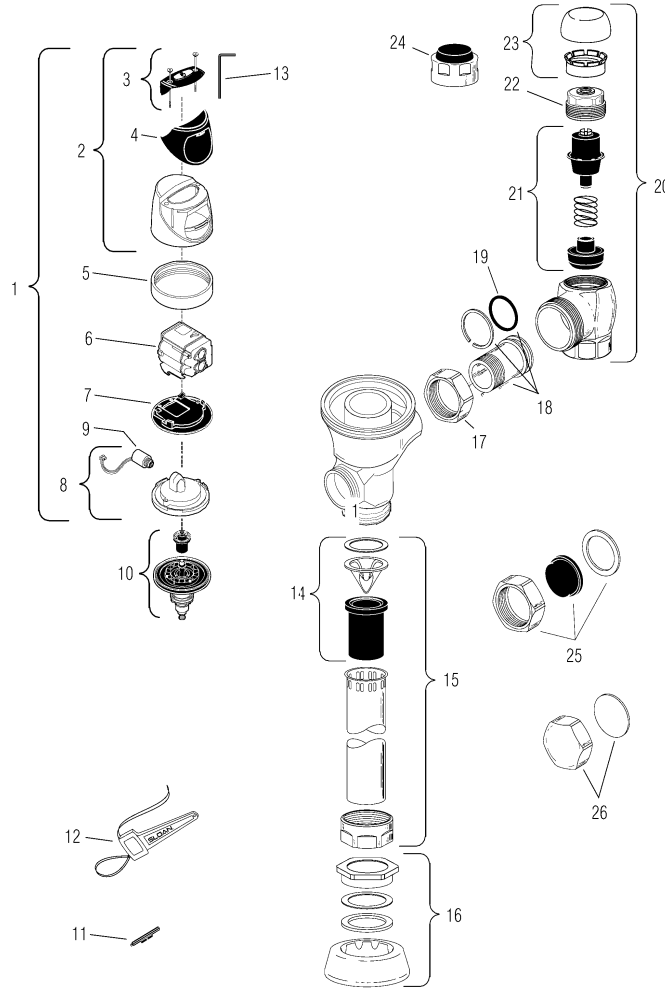

Repair Parts

Part #	Mfg #	Model	Ref	Description	Price
057970	3301500	EAF-12		Diaphragm Only Kit	
043726	3325815	EBV-1018-A	26	Handle Cap - Decorative	
066898	3325001	EBV-1020-A	10	1.6 Flex Tube Diaphragm Inside Part Kit	
066899	3325000	EBV-1022-A	10	OptimaPlus Repair Kit, 1.0, 1.5 Urinal	
093722	3325450	EBV-129-A-C	6	G2 Electronic Module - Water Closet	
084024	3325451	EBV-129-A-U	6	G2 Electronic Module - Urinal	
100551	0325172	EBV-130-A	3	G2 Override Button Assembly	
080085	3325453	EBV-136-A	9	Isolated Solenoid	
130178	0325160	EBV-138-A	1	G2 Cover/Ring/Sensor Assembly - Water Closet	
085884	3325462	EBV-144-A	9	Isolated Solenoid Operator	
071385	0325176	EBV-146-A-C		G2 Electronic Module Optima 1.6 - Closet	
071242	0325177	EBV-146-A-U		G2 Sensor Module Urinal	
028637	5325813	EBV-18		Quad Ring	

Sloan Repair Parts

Sensor Operated Flushometer Parts (Continued)
OptimaPlus® Flushometer Parts

Part #	Mfg #	Model	Ref	Description	Price
022200	3325013	EBV-60-A		Metal Cover Assembly with Override Button - Water Closet	
057264	0305118	EL-165-2		Solenoid Coil, 24VAC	
049083	0305165	EL-163-A		Sloan Solenoid Assembly	
010216	3308855	H-541-AA	21	1" Screwdriver Angle Stop Repair Kit	

Flush Valve Transformer



Part #	Mfg #	Model	Description	Price
010126	0345154	EL-154	120VAC/24VAC, 50/60Hz (50VA), Box-Mount	

Optima® Flushometer Parts
110/111/115/116/140/152/153 ES-S

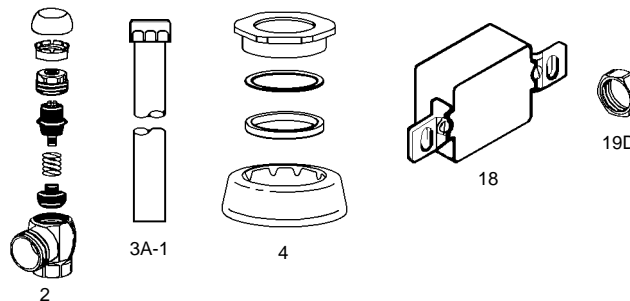

Part #	Mfg #	Model	Ref	Description	Price
010125	3305621	EL-1500-L	18	Sensor Repair Kit - Closet	

Optima® Systems Solenoid/Sensor Parts and Assemblies List

Part #	Mfg #	Model	Description	Price
010123	0337086	DO-22	O-Ring	

Showerheads
Act-O-Matic



Part #	Mfg #	Model	Description	Price
010088	4020100	AC-11	2.5 gpm Std Self-Cleaning Showerhead, CP	

Repair Parts

Sloan Repair Parts

Replacement Parts and Accessories

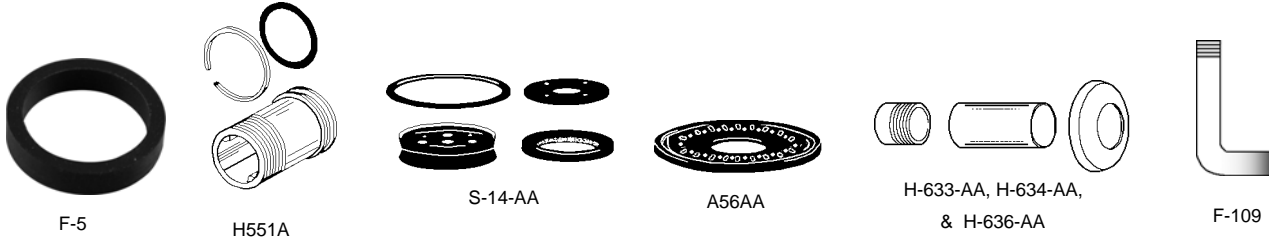

Repair Parts

Part #	Mfg #	Model	Description	Price
023238	3301077	A-1008-A	3/4" Spud Coupling Kit	
029505	3301079	A-1010-A	1-1/2" Spud Coupling Kit	
057971	3301501	A-1038-A	Closet Repair Kit	
032380	0301104	A-175-A	Low Pressure Guide Repair Kit (P-600-EGL)	
045723	0301178	A-19-ALCM	Closet Relief Valve, Brass LC	
010103	0301255	A-50	Super Wrench	
010104	5301170	A-56-A	Segment Diaphragm w/A-29 Copper Gasket	
010105	5301176	A-56-AA	Diaphragm Repair	
010122	3303398	C-70-A	Push Button For Concealed Royal & Crown - Contains #7-11	
032633	3305043	EL-128-A	Actuator Cartridge	
019381	3305620	EL-1500	Urinal Sensor Repair Kit	
028928	0396322	F-109	1-1/2" x 21" x 5" Tubular Bend, CP	
010134	5306055	F-3	3/4" Red Friction Ring	
010133	5306058	F-3	1-1/2" Red Friction Ring	
010135	5306113	F-5	3/4" Slip Joint Gasket	
020802	3308772	H-1010-A	1" Vandal Resistant Stop Cap	
010143	3308277	H-47-AA	Stop Repair Kit	
010146	3308780	H-533-AS	Sweat Solder Kit For 1" Supply Closet & Urinal	
010147	3308786	H-536-A	3/4" Sweat Adapter Kit	
010151	0308803	H-551-A	3-1/16" Long Adjustable Tailpiece, CP	
034119	0308805	H-551-A	4-1/16" Long Adjustable Tailpiece, CP	
016687	5308850	H-584	Screwdriver Control Stop Seat Only For 1" H-540, H-600 & H-700 Series Stop	
043117	3308782	H-633-AA	Sweat Solder Kit 1" w/Cast Set Screw Flange (YBYC)	
111258	3308785	H-634-AA	Sweat Solder Kit 1", CP	
084384	3308788	H-636-AA	Sweat Solder Kit 3/4" w/Cast Set Screw Flange (YBYC)	
010159	0310083	J-212-A	1-1/2" Solid Ring Pipe Support - 5 C/E Complete, CP	
010166	5319046	S-14-A	Molded Cup	
010170	5319086	S-30	1-1/2" Gasket	
010175	3322079	V-101-A	Vacuum Breaker Repair Kit	
010174	5322001	VBF-5	1-1/2" Gasket	

Sloan Repair Parts

Vacuum Breaker



Part #	Mfg #	Model	Description	Price
010185	5323010	V-500-A	1-1/2" x 11-1/2", RB (140 ES-S & 152 ES-S)	
010179	0323014	V-500-AA	1-1/2" x 13-1/2", CP	
010180	0323015	V-500-AA	1-1/2" x 21-1/2", CP	
010181	0323016	V-500-AA	1-1/2" x 24-1/2"	
010183	0323020	V-500-AA	1-1/4" x 21-1/2"	
021735	0323057	V-500-AA	1-1/2" x 32-1/2"	
010184	0323210	V-500-AA	3/4" x 15", CP	

Repair Parts

Sloan Repair Parts

FLUSHMATE® Replacement Parts



BU100505-K



C-100500-K

Part #	Mfg #	Description	Price
080376	B-108288	Duckbill Valve (Air Inducer) Allows Air Into Tank but Not Out	
046465	BL100504-3-K	Lower Supply Kit for 503 & 504 Series	
046464	BU100505-K	Upper Supply Kit for Flushmate Pressurized Tank	
010120	C-100500-K	Flush Cartridge for All Flushmate Series	
046467	RK100100	Replacement Supply System for All Series Except 503 & 504	

Repair Parts

Speakman Repair Parts

Speakman® Parts

Part #	Mfg #	Description	Price
068748	RPG05-0520	Vacuum Breaker Hub Repair Kit	

Repair Parts

T & S Brass Repair Parts

Handles



- Chrome-plated zinc handle
- B-WH models come with screw, all others, screw is sold separately

Part #	Mfg #	Description	Price
010415	001636-45	Lever Handle Cold Index	
010416	001637-45	Lever Handle Hot Index	

Spindle



002711-40



002712-40

Part #	Mfg #	Description	Price
010419	002711-40	Cold Spindle 174A	
010420	002712-40	Hot Spindle 175A	
028123	002713-40	Eterna LH Spindle Assembly	
028124	002714-40	Eterna RH Spindle Assembly	
085560	005960-40	Eterna Spindle Assembly, Hot	
110659	005959-40	Eterna Spindle Assembly, Cold	

Swing Nozzles



Part #	Mfg #	Description	Price
044168	062X	12" Swing Nozzle	

Repair Kits



B-9K



B-10K

Part #	Mfg #	Description	Price
061402	B-9K	Lever Handle Kit	
010405	B-10K	Repair Kit for B-0107	
046499	B-21K	Eterna Cartridge Replacement	
107843	B-39K	Brass Rotary Waste Valve Parts Kit	

Supply Nipple

- Brass

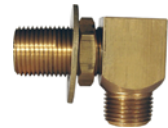

Part #	Mfg #	Description	Price
110214	B-0230-K	Angle Supply Nipple	

Waste Valve with Drain Adapter - Twist



Part #	Mfg #	Description	Price
107844	B-3940	3.0" Sink Opening, 1.5" or 2.0" Drain Outlet	

T&S Brass Parts

Bonnet Assembly



Part #	Mfg #	Description	Price
030182	002856-40	B502 Bonnet Assembly	

Washer



Part #	Mfg #	Description	Price
010411	001041-45	Spreader Washer	

Parts & Accessories

Part #	Mfg #	Description	Price
010417	018L	Stem	
010427	067L	Stem	
010426	066L	Removable Insert	
010425	064L	Removable Insert	

Repair Parts

Taco Repair Parts

Pro-Fit™ Replacement Parts

- For Bell & Gossett and Armstrong pumps
- Rugged, cast zinc w/steel reinforced eyelets
- Heavy-duty spring
- Fits all 1/2" motor shafts
- Std Woods 3-J for all 5/8" motor shafts (opt 1/2" inserts included)

Coupler



Part #	Mfg #	B&G Part #	Armstrong Part #	Price
079914	COU-ABC-100	118705,189110,118712,118723	806026-001	
079915	COU-D100	118473,118709	810120-003/006,806137-000,807436-000	

Repair Parts

Thermolec Repair Parts

Parts & Accessories

Part #	Mfg #	Description	Price
130137	10-02-005	Magnetic B/U, 50A Spade Style Contactor	
130139	10-02-006	CCT-140 SPDT Diverting Valve Pump Relay	
128230	17-02-102	CBLR055 Incoloy Element 5kW, 240V	
121185	17-02-103	CBLR060 Incoloy Element 5.75kW 240V	
130133	17-02-107	CBLR130 Electronic Temperature. Sensor - Supply Water	
110489	17-02-110	CBLR025 Mono Energy Control Board TH-600-M	
130131	17-02-115	CSR113 Solid State Relay SSR-20-DC	
130130	17-02-116	CTR040 Control Transformer 30VA 240/24V	

Repair Parts

Triangle Tube Repair Parts

Prestige Parts

Part #	Mfg #	Description	For:	Price
115737	PSSSENS01	Outdoor Sensor Kit		
093308	PSSTND01	Floor Stand	PS110, PS175, PS250	
107252	PSSTND02	Wall Kit, Recommended f/Hanging on Anything Other Than a Masonry Wall		
107253	PSSTND03	Floor Stand Kit Use w/PSSTND02 Wall Kit	PE110 & PS399	

Electronic Components

Part #	Mfg #	Description	For:	Price
091015	PSRKIT04	NTC Sensor	PS110, PS175 & PS250	
091016	PSRKIT13	Blower Kit w/Gasket	PS110 & PS175	
091019	PSRKIT19	Transformer with Surge Protection	SOLO 110	
114363	PSRKIT20	Control Module Display	SOLO 110	
118949	PSRKIT50	Control Module	SOLO 110	
120439	PSRKIT55	Blower Kit w/Gasket	PS110	
117640	PSRKIT58	MCBA Control Module Replacement Kit	PE110	
138226	PSRKIT63	NTC3 Domestic Hot Water Sensor	PE110	

Burner Components

Part #	Mfg #	Description	For:	Price
091021	PGRKIT01	Gas Valve Kit	PS110	
091017	PSRKIT15	Igniter w/Gasket	SOLO 110	
120440	PSRKIT41	Gas Valve	SOLO 399	

Internal Components

Part #	Mfg #	Description	For:	Price
091020	PGRKIT20	Lwco Pressure Device	SOLO 110	
118581	PSRKIT40	399 Blower with Gasket	SOLO 399	

Repair Parts

Union Brass Repair Parts

**Parts
Valve Assemblies**

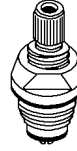

80038



80080

Part #	Mfg #	Description	Price
010503	80038	1837AC Cold Valve Assembly	
051376	80080	1839A-C Cold Valve Assembly	

Ruud Heating & AC Repair Parts

Blower Wheels

Blower Wheel

- CW Rotating



Part #	Mfg #	Rotation	Nom Size	Overall Dia x Overall W	Hub	Disc Shape (Hub Side)	# of Blades	Price
009619	70-18631-01	CW	9" x 7"	9-1/2" x 7-1/8"	1/2"	Convex	43	
024572	70-20218-02	CW	10" x 7"	10-5/8" x 7-3/16"	1/2"	Convex	48	
016858	70-18629-01	CW	10" x 10"	10-5/8" x 10-5/8"	1/2"	Concave	48	
051174	70-23110-30	CCW	10" x 10"	10-5/8" x 10-3/4"	1/2"	Concave	48	
030369	70-23111-05	CW	11" x 7"	11-15/16" x 7-1/8"	1/2"	Concave	54	
074404	70-23111-43	CW	11" x 7"	11-15/16" x 7-1/8"	1/2"	Concave	54	
049454	70-24254-02	CW	11" x 7"	11-15/16" x 7-1/8"	1/2"	Convex	54	
009622	70-20602-01	CW	11" x 10"	11-7/8" x 10-11/16"	1/2"	Concave	54	
125744	70-103207-01	CW	12" x 7"	12-7/8" x 7"	1/2"	Convex	43	
050595	70-24119-01	CW	12" x 7"	12-3/4" x 7"	1/2"	Concave	43	
086470	70-24179-01	CW	12" x 11"	12-25/32" x 11-1/8"	1/2"	Convex	43	
019546	70-24041-01	CW	12" x 11"	12-3/4" x 11-1/8"	1/2"	Concave	43	
051179	70-42540-02	Reversible	15" x 15"	15" x 15"	1"	Double Convex	51	

Compressors

R-410 Scroll Compressor

Copeland R-410A Air Conditioning Scroll Compressor - 208/230-1-60

- Crankcase heater not included



Repair Parts

Part #	Mfg #	Vendor #	Capacity MBTUH	Run Capacitor	Start Capacitor	Start Kit	Kick Start	Crankcase Heater	Price
113737	55-102045-14S	ZP16K5E-PFV	15.5	30/370	88-106/330	SK-A1	42-TO5	44-17402-44	
113736	55-102045-01S	ZP21K5E-PFV	21.3	40/370	88-106/330	SK-A1	42-TO5	44-17402-44	
113735	55-102045-02S	ZP21K5E-PFV	21.3	40/370	88-106/330	SK-A1	42-TO5	44-17402-44	
113903	55-102045-31S	ZP24K5E-PFV	24.0	40/370	88-106/330	SK-A1	42-TO5	44-17402-44	
113901	55-102045-03S	ZP31K5E-PFV	31.0	45/370	88-106/330	SK-A1	42-TO5	44-17402-44	
131585	55-102045-17S	ZP38K5E-PFV	37.5	45/370	175-216/330	SK-A3	42-KS1	44-17402-45	
113730	55-102045-09S	ZP42K5E-PFV	42.0	70/370	88-106/330	SK-A1	42-KS1	44-17402-45	
113734	55-102045-15S	ZP34K5E-PFV	34.0	45/370	88-106/330	SK-A1	42-TO5	44-17402-45	
113900	55-102045-26S	ZP51K5E-PFV	51.0	70/370	175-216/330	SK-A3	42-KS1	44-17402-45	
113729	55-102045-13S	ZP54K5E-PFV	54.0	80/370	175-216/330	SK-A3	42-KS1	44-17402-45	

Ruud Heating & AC Repair Parts

R-22 Scroll Compressor

Copeland R-22 Air Conditioning Scroll Compressor - 208/230-1



Part #	Mfg #	MBTUH*	Electrical	RLA	Max Dimensions H x W x L	Stub Tube Conn(ID") Dischg, Suc	Mnt Dim W x L	Price
133280	ZR16K5E-PFV-800	20.3	208/230-1-60	9.3	15.86" x 9.50" x 9.50"	1/2", 3/4"	7.5" x 7.5"	
222707	ZR21K5E-PFV-800	27.5	208/230-1-60	32.9	18.75" x 11.23" x 10.38"	22/25", 1-1/8"	7.5" x 7.5"	
133217	ZR25K5E-PFV-800	32.8	208/230-1-60	15	15.86" x 9.50" x 9.50"	1/2", 3/4"	7.5" x 7.5"	
133806	ZR28K5E-PFV-800	36.9	208/230-1-60	15.7	15.86" x 9.50" x 9.50"	1/2", 3/4"	7.5" x 7.5"	
222708	ZR32K5E-PFV-800	42.6	208/230-1-60	17.1	15.86" x 9.50" x 9.50"	1/2", 3/4"	7.5" x 7.5"	
180171	ZR42K5E-PFV-800	54.8	208/230-1-60	22.1	16.94" x 9.56" x 9.59"	1/2", 7/8"	7.5" x 7.5"	
141164	ZR54K5E-PFV-800	69.7	208/230-1-60	28.2	16.94" x 9.56" x 9.59"	1/2", 7/8"	7.5" x 7.5"	

Expansion Valves

Thermal Expansion Valve

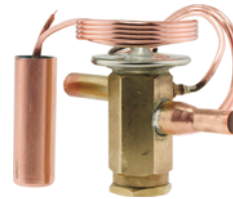

Part #	Mfg #	Description	Price
140730	611006	2T R-22 Expansion Valve	
140731	611007	3T R-22 Expansion Valve	
140732	611008	4T R-22 Expansion Valve	
140733	611009	5TR-22 Expansion Valve	
140734	611011	2T R-410A Expansion Valve	
140735	611012	3T R-410A Expansion Valve	
140736	611013	4T R-410A Expansion Valve	
134296	611064	3T R-410A To R-22 Conversion, Thermal Expansion Valve	
141976	61-103652-05	2T R-410A TX Expansion Valve	
131854	61-21922-46	1.5T R-22 TXV Expansion Valve	
105705	61-21922-47	2T R-22 TXV Expansion Valve	
106949	61-21922-48	2.5T R-22 TXV Expansion Valve	
131857	61-21922-50	4T R-22 TXV Expansion Valve	
116721	61-21922-51	5T R-22 TXV Expansion Valve	
105707	61-21922-82	2.5T R-22 TXV Expansion Valve	
105708	61-21922-83	3T R-22 TXV Expansion Valve	
105709	61-21922-84	4T R-22 TXV Expansion Valve	
105710	61-21922-85	5T R-22 TXV Expansion Valve	

Repair Parts

Ruud Heating & AC Repair Parts

Fan Blades

Fan Blade with Integral Hub

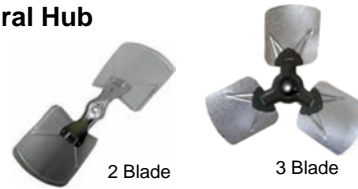

Part #	Mfg #	Diameter	Pitch	Rotation	# of Blades	Price
079832	70-21859-05	18"	28°	CCW	2	
123681	70-102033-05	18"	30°	CCW	3	
071438	70-20607-04	20"	27°	CCW	2	
107473	70-102011-06	20"	29°	CCW	3	
084834	70-21858-06	22"	21°	CCW	2	
009623	70-20608-01	22"	27°	CCW	2	
105796	70-102011-07	22"	35°	CCW	2	
107476	70-102011-09	24"	22°	CCW	2	
024245	70-19897-01	24"	22°	CCW	3	
103769	70-100580-03	24"	22°	CCW	3	
123680	70-102011-03	24"	24°	CCW	2	
084787	70-26166-01	24"	24°	CCW	2	
096139	70-100580-04	24"	28°	CCW	3	
086771	70-23137-01	24"	19°	CCW	2	
117441	70-21858-17	24"	22°	CCW	3	

Fan Center

- Terminals: W, G, Y, R, C
- 120V Primary voltage
- 24V Secondary voltage
- Transformer frequency: 50,60Hz
- Relay not included, SPDT configuration
- Relay coil voltage: 24V



Part #	Mfg #	Description	Price
009344	47-19807-04	Fan Center, 4-1/4" x 4-1/4"	

Gas Valves



Part #	Mfg #	Description	Price
009499	60-22174-02	Natural Gas Valve, 150,000 BTU/HR @ 1" WC Pressure Drop	
009501	60-22447-01	Natural Gas Valve, 150,000 BTU/HR @ 1" WC Pressure Drop	
067321	60-24215-03	Modulating Natural Gas Valve	
127859	60-24394-01	Natural Gas Valve, 150,000 BTU/HR @ 1" WC Pressure Drop	

Repair Parts

Ruud Heating & AC Repair Parts

Gas Control



Part #	Mfg #	Description	Price
123243	SP20166A	Gas Valve - Natural Gas	
129359	SP20166B	Gas Valve - Natural Gas	
128611	SP20166C	Gas Valve - Natural Gas	

White-Rodgers 36G Gas Valve

- 140,000 BTUH Capacity @ 1"wc pressure drop
- Slow opening
- Hot Surface/ Direct Spark

60-24180-81



Part #	Mfg #	Description	Price
125567	60-24180-81	36G23-202E91 1/2" NG Hot Surface/Direct Spark 1-Stg 140,000	
143224	60-101921-81	36G55-521 1/2" NG Hot Surface/Direct Spark 2-Stg 140,000 BTUH Capacity	

White-Rodgers 36J Gas Valve

- Natural gas
- 140,000 BTUH Capacity @ 1"wc pressure drop
- 4-3/4"L x 2-3/8"W x 4-1/4"H



Part #	Mfg #	Description	Price
179394	60-103901-01	36J23-502 1/2" NG Hot Surface/Direct Spark 1-Stg 140,000 BTUH Capacity	

Honeywell VR8215S1313 Gas Valve

- Natural gas
- 150,000 BTU/HR Capacity @ 1"wc pressure drop
- 4-7/16"L x 2-3/4"W x 4-1/8"H
- Hot Surface/Direct Spark



Part #	Mfg #	Description	Price
172007	60-105055-01	VR8215S1313 1/2" NG Hot Surface/Direct Spark 1-Stg 150,000 BTU/HR Capacity	

Repair Parts

Ruud Heating & AC Repair Parts

Honeywell VR8304 Intermittent Pilot Dual Automatic Valve Combo Gas Control

- For use in 24VAC gas-fired, intermittent pilot with capacities from 30-415 cfh
- Includes all standard features plus:
 - Controls include 100% safety shut-off, manual valve, two automatic operators, pressure regulator & pilot adjustment
 - Standard & slow opening natural gas models include natural to LP gas conversion kits; LP to natural gas conversion kits are also available
 - All adjustments, wiring connections & pilot outlets are accessible from the top of control
 - Adjustable servo regulator
 - Compatible with ECO connector
 - On-Off lighting sequence
 - Use with S86F,H; S860D; S8600F,H; S8610 & S90A,B Control Modules
 - Single stage unless otherwise noted
 - Capacities based on 1" p.d. 30,000 BTUH minimum, 300,000 BTUH maximum

Honeywell

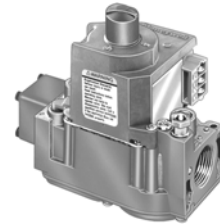

Part #	Mfg #	Description	Price
009498	60-21621-81	VR8304M3101 3/4" NG Pilot 1-Stg 270,000 BTUH Capacity	

Gas Valve Spring Kit

Part #	Mfg #	Description	Price
009490	60-18759-07	Gas Valve Spring Kit	

Heat Cell

Part #	Mfg #	Description	Price
008940	AS-61164-83	Heat Cell - Aluminum	

Inducer Motors

Induced Draft Blower with Gasket



Part #	Mfg #	Description	Price
139892	70-102691-81	120V 1-Stg Polymeric Inducer Housing Right Side Discharge	
090631	70-101087-81	120V 1-Stg Sheet Metal Inducer Housing Right Side Discharge	
160013	70-104157-82	Induced Draft Blower Assembly with Gasket	
009627	70-21496-83	120V 1-Stg Polymeric Inducer Housing Left Side Discharge	
009632	70-22436-02	120V Induced Draft Blower w/ Gasket	
024248	70-23641-81	208-230V 1-Stg Sheet Metal Inducer Housing Right Side Discharge	
072199	70-23641-82	380-415V, 460V, 50-60Hz 1-Stg Induced Draft Blower w/Gasket	
009635	70-24033-01	120V 1-Stg Polymeric Inducer Housing Right Side Discharge	
041979	70-24157-03	120V 1-Stg Cast Metal Inducer Housing Right Side Discharge	
027297	70-24206-01	120V 2-Stg Polymeric Inducer Housing Right Side Discharge	

Repair Parts

Ruud Heating & AC Repair Parts

1-Stage Draft Inducer Blower

- 115V 1-Speed
- For use with Rheem/Ruud gas furnaces models RGRK-07EMAES and UGRK-07EAMES



Part #	Mfg #	Description	Price
120707	703020	Draft Inducer Blower	
131722	70-24071-94	Draft Inducer Blower	

2-Stage Draft Inducer Blower

- 115V 2-Speed
- For use with Rheem/Ruud gas furnaces models RGRK-07EMAES and UGRK-07EAMES



Part #	Mfg #	Description	Price
136280	70-100612-03	Draft Inducer Blower	
139895	70-100612-81	Draft Inducer Blower	
139892	70-102691-81	Draft Inducer Blower	
139896	70-102814-81	Draft Inducer Blower	
139894	70-103086-01	Draft Inducer Blower	
145465	70-103597-01	Draft Inducer Blower	

Blower Assembly



Part #	Mfg #	Description	Price
015970	70-22165-81	Blower Assembly	
009631	70-22436-01	Blower Assembly	
137367	AP15109-1	Blower Assembly	

Vent Motor with Blades

- 208/230V, Nominal 3,000 rpm
- Includes centrifugal proving switch
- Mounting bolt pattern 4-1/4" x 4-1/4"
- Includes (3) fan blades (3", 3-1/2" and 4" diameter)



Part #	Mfg #	Description	Price
009414	51-21964-11	Vent Motor with Blades, 208/230V Nominal 3000 rpm	

Repair Parts

Ruud Heating & AC Repair Parts

Motor Mount



Part #	Mfg #	Description	Price
022307	562300109	Blower Motor Mount Kit For 48 Frame	
093274	AE-58384-81	Screw Mounting Kit, 5-5/8" 48 Frame Motors, 16" Nom Blower Mounting Bolt Circle Dia, (4) Arms	
041165	AE-61698-82	Screw Mntg Kit, 5-5/8" 48 Frame Motors, 14-13/16" Nom Blower Mntg Bolt Circle Dia, (4) Arms	
008936	AS-55306-02	Condenser Motor Plate Mount Kit	
223191	AS-55306-82	Cendenser Motor Plate Kit	

Limit Controls

Therm-O-Disc Temperature Limit Control Switch

36T Small Flanged Airstream - Manual Reset

- 120/230V maximum rating, 15/10A maximum current rating
- Enclosed disc face
- SPST Switching
- Normally closed
- 300° Open temperature



Part #	Mfg #	Temp Open	Tolerance Open	Color Code	Mounting Tube	Price
009391	47-22861-02	300°F	+/-14°F	Blue	5/32"	

36T Special Small Flanged Airstream - Manual Reset

- 120/230V Max rating, 15/10A Max current rating
- Enclosed disc face
- SPST Switching
- Normally closed
- 250° Open temperature



Part #	Mfg #	Temp Open	Tolerance Open	Color Code	Mounting Tube	Price
103688	47-22861-03	250°F	+/-12°F	--	3/16"	

74T Large Flanged Airstream - Auto Reset

- 230V Max rating, 25A Max current rating
- Enclosed disc face
- SPST Switching
- 3/8" Maximum mounting insertion depth



Part #	Mfg #	Description	Price
141499	47-25115-02	Open Temp: 135°F - 175°F; Close Temp: Open Temp Minus 40°F, 40° Nom Temp Difference	
141500	47-25115-03	Open Temp: 175°F - 215°F; Close Temp: Open Temp Minus 40°F, 40° Nom Temp Difference	

Repair Parts

Ruud Heating & AC Repair Parts

Limit Control Switch - Auto Reset - 69T Heat Assisted

- Normally closed
- Exposed disc face
- SPST Switch type



Part #	Mfg #	Description	Price
009388	47-22860-01	95°F Close Temperature Red	
009389	47-22860-02	100°F Close Temperature Blue	

Limit Switch - Auto Reset 60T Series

- Normal closed
- Flanged airstream
- 1-Pole
- SPST Switch type
- Normal closed



Part #	Mfg #	Description	Price
160015	47-104465-01	95°F Close Temperature Yellow	

Limit Control Switch - Manual Reset - 36T

- Flanged Airstream



Part #	Mfg #	Description	Price
009375	47-22453-01	Normally Closed Enclosed Disc Face SPST	
009376	47-22453-02	Normally Closed Enclosed Disc Face SPST	
009390	47-22861-01	Normally Closed Exposed Disc Face SPST	
009393	47-22862-02	Normally Closed Blue Exposed Disc Face SPST	
009395	47-22862-04	Normally Closed Orange Enclosed Disc Face SPST	

Limit Control/Switch



Part #	Mfg #	Description	Price
009351	47-21663-01	Limit Switch	
009367	47-21900-05	Limit Control	
009368	47-21900-06	Limit Control	
009371	47-22383-13	Limit Switch	
026839	47-22383-33	Limit Control	

Repair Parts

Ruud Heating & AC Repair Parts

Limit Control Switch - Auto Reset - 36T

- Enclosed disc face
- SPST Switch type
- Normally closed
- Board mount 90° strap angle



Part #	Mfg #	Description	Price
009356	47-21711-06	150°F Close Temperature	
009360	47-21711-10	150°F Close Temperature	
034226	47-25349-02	150°F Close Temperature Blue/Blue	
036843	47-25349-03	150°F Close Temperature Yellow/Yellow	
009361	47-21711-11	160°F Close Temperature	
038081	47-25349-01	160°F Close Temperature Red/Red	
038093	47-25349-05	180°F Close Temperature Orange/Orange	
038095	47-25350-07	180°F Close Temperature Green/Green	
034120	47-25350-01	190°F Close Temperature Red/Red	
009354	47-21711-04	200°F Close Temperature	
036657	47-25350-09	200°F Close Temperature Tan/Tan	
040953	47-25350-06	150°F Clos Temperature Brown/Brown	
009403	47-24006-08	Limit Switch	
059560	47-25350-02	Limit Control	
050264	47-25350-04	Limit Control	
085327	47-25350-05	Limit Control	
145464	47-25350-12	Limit Control, 195°F Open	

Motors
ECM Motor



Part #	Mfg #	Description	Price
142897	51-102728-05	ECM Outdoor CA330R Motor	
169001	51-104304-28	1/2 hp Variable Speed ECM Motor	
166659	51-104306-01	Variable-Speed 1 hp Direct Drive ECM 48 Frame	
166281	51-104306-24	1 hp ECM Motor	
166321	51-104306-25	1 hp ECM Motor	
137902	51-42534-24	1/3 hp Fan Motor	
145469	51-102602-01	1/2 hp Communicating Motor	

Repair Parts

Ruud Heating & AC Repair Parts

OEM Condenser Motor (208/230V)

- These motors are OEM replacements for Rheem, Ruud, and WeatherKing models; additionally they may be suitable for after market retrofit in many other applications
- Single speed, single phase



Part #	Mfg #	Description	Price
086497	51-100999-02	1/10 hp 825 rpm 208/230V Condenser Motor	
085274	51-100999-03	1/6 hp 1075 rpm 208/230V Condenser Motor	
086548	51-100999-04	1/5 hp 1075 rpm 208/230V Condenser Motor	
086549	51-100998-05	1/3 hp Condenser Motor	
113859	51-100998-13	1/3 hp 1075 rpm 208/230V Condenser Motor	
123683	51-102500-02	Sgl Speed, 1/6 hp 1075 rpm 208/230V CCW 3/370 Capacitor	
105405	51-102500-03	1/6 hp 825 rpm 208/230V Condenser Motor	
105406	51-102500-04	1/5 hp 825 rpm 208/230V Condenser Motor	
113905	51-102500-05	1/10 hp 825 rpm 208/230V Condenser Motor	
099184	51-42179-01	Sgl Speed, 1/3 hp 1075 rpm 208/230-1-60 CCW 10/370 Run Capacitor	
052997	51-42534-01	Sgl Speed, 1/3 hp 1075 rpm 208/220/230-1-50/60 CCW 10/370 Run Capacitor	

Ruud Wholesale Condenser Motor (208/230V)



Part #	Mfg #	Description	Price
009426	51-23055-12	1/5 hp Direct Drive 230V 825 rpm	
009425	51-23055-11	1/5 hp Direct Drive 230V 1075 rpm	

Ruud Wholesale Condenser Motor (460V)



Part #	Mfg #	Description	Price
086789	51-23063-11	Sgl Speed, 1/3 hp 1075 rpm 460-1-60 Reversible 7.5/370 Capacitor	

Condenser Motor



Part #	Mfg #	Description	Price
132537	51-100998-08	1/8 hp Condenser Motor	

Ruud Heating & AC Repair Parts

Motors (Continued)

Condenser Motor

Part #	Mfg #	Description	Price
125111	51-102728-11	ECM Condenser	
125103	51-102728-12	ECM Condenser Fan Motor	
125112	51-102728-13	ECM Condenser	
125432	51-102870-01	ECM Condenser (Outdoor)	
125110	51-102870-03	Condenser Fan Motor	
140687	5464	1/6 - 1/3 hp 825 rpm 208/230V Emerson RESCUE Condenser Motor	
061734	51-21853-15	Condenser Motor - 1/3 hp 460/1/60	

TripSaver Condenser Motor



Part #	Mfg #	Description	Price
009424	51-23053-21	1/3 / 1/5 hp Direct Drive 230V 1,075 rpm	
143484	51-103823-01	1 hp 230V X13 Motor	

OEM Indoor Blower Motor



Part #	Mfg #	Capacitor	HP	Volts	Amps	RPM/Speed	Rotation	Price
128889	51-103243-01	15mfd/370V	1/2 hp	120-1-60	8.00A	1,075/4	CCW	
042374	51-23679-01	10mfd/370V	1/2 hp	208/230	2.70A	1,075/3	CW	

Trip Saver Indoor Blower Motor



Part #	Mfg #	Description	Price
009422	51-23022-41	4-Speed 1/6-1/2 hp 1,075 rpm 208/230-1-60 REV 5/370, 7.5/370 or 10.370 Capacitor	

Repair Parts

Ruud Heating & AC Repair Parts

Blower Motor



Part #	Mfg #	Description	Price
100478	51-101879-01	1/3 hp 240V X-13 Blower Motor	
094848	51-101880-01	1/2 hp 208/230V 1-Phase X-13 Blower Motor	
113814	51-102497-01	3/4 hp 230V Variable Speed X-13 Blower Motor with Resilient Rotor	
113813	51-102497-02	3/4 hp 230V Variable Speed X-13 Blower Motor	
009418	51-23012-41	1/6 - 1/2 hp 1,075 rpm 120V 4-Speed Reversible Rotation Tripsaver™ Blower Motor	
028318	51-23017-42	1/4 - 3/4 hp 1,075 rpm 120V Indoor Blower Motor	
016108	51-24070-02	1/2 hp Indoor Blower Motor 120V 1,075 rpm	
024237	51-23555-02	Blower Motor - 3/4 hp 208/230/1/60	
124801	51-21898-01	3/4 hp 208-230/1 V 1075 rpm	
038103	51-23102-08	1/2hp Dir Dr 208-230V 825 rpm	

Motor

Part #	Mfg #	Description	Price
009420	51-23015-91	1/5 hp 120/1/60 1075 rpm 3-Speed	
141494	51-23027-31	Blower Motor 3-Speed 230V 3/4 hp	
145470	51-102605-01	1 hp 120/230V ECM Motor	
127336	51-24374-27	1/2 hp ECM Blower Motor	
125741	51-24374-28	1/2 hp ECM Blower Motor	
052874	51-24376-03	Motor w/ICM Module (Modulating Furnace)	
078007	51-24382-81	1/2 hp ECM Module	
134008	51-102008-08	Condenser Fan Motor	

Motor Mounting Kit

Part #	Mfg #	Description	Price
125546	70-24104-82	Motor Mounting Kit	

Relay's

Control Relay

Sealed Case (SPDT) Control Relay



Part #	Mfg #	Contact Bias	Coil Volts	FLA @120V	FLA @230V	LRA @120V	LRA @230V	Price
009290	42-25104-06	NO/NC	24V	14	8	84	48	

Ruud Heating & AC Repair Parts

Relay - DPTD



Part #	Mfg #	Contact Bias	Coil Volts	FLA @120V	FLA @230V	LRA @120V	LRA @230V	Price
009222	42-18287-12	NO/NC (2)	24V	12	6	60	35	

Open Coil (DPDT) Control Relay



Part #	Mfg #	Contact Bias	Coil Volts	FLA @120V	FLA @230V	LRA @120V	LRA @230V	Price
027431	42-25106-01	NO/NC (2)	24V	13.8	6.9	82.8	41.4	

Control Relay - Small Sealed Case (SPDT)



Part #	Mfg #	Contact Bias	Coil Volts	FLA @277V	LRA @230V	LRA @277V	Price
117427	42-23114-06	NO/NC	24V	20NO, 10NC	60NO, 33NC	60NO, 33NC	

Start Relays - Potential Type



Part #	Mfg #	Hot Pickup (V)	Cold Pickup (V)	Dropout (V)	Max Cont Coil Volt (V)	Start Kit Relay Code	Price
041054	42-25105-01	170-180V	162-175V	40-90V	336V	A	

Time Delay Relay



Part #	Mfg #	Time Delay Adj.	Make Time Delay	Voltage Rating	Current Rating Steady State	Current Rating Inrush	Price
042350	42-ICM102	Variable	.03 - 10 Min	18-230 VAC	1.5	15	

Repair Parts

Ruud Heating & AC Repair Parts

Time Delay Relay



Part #	Mfg #	Time Delay Adj.	Break Time Delay	Voltage Rating	Current Rating Steady State	Current Rating Inrush	Price
121707	47-23433-93	Fixed	.17 Min	18-30 VAC	1	10	

Timer Delay



Part #	Mfg #	Time Delay Adj.	Break Time Delay	Voltage Rating	Current Rating Steady State	Current Rating Inrush	Price
092118	42-ICM	Variable	.17 -16.6 Min	18-230 VAC	1	10	
042351	42-ICM203	Variable	.03 - 10 Min	18-230 VAC	1.5	15	

Time Delay Relay - On Delay On Break (Anti-Short Cycle)



42-22655-02

Part #	Mfg #	Time Delay Adj.	Break Time Delay	Voltage Rating	Current Rating Steady State	Current Rating Inrush	Price
044912	42-22655-02	Fixed	5 Min	18-30 VAC	1.5	-	
047231	42-22655-03	Fixed	.5 Min	18-30 VAC	1.5	-	

Sequencers

Sequencer

24V Angle Bracket with (2) Mounting Holes Sequencer

- DPST-NO

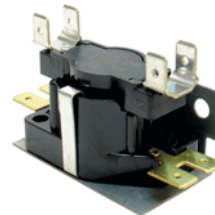

Part #	Mfg #	Poles	Sequencing Off	Sequencing On	Switching	Price
050196	42-23116-08	2	10 - 30	30 - 60	DPST NO	
034057	42-23116-06	2	10 - 40/30 - 160	90 - 160/30 - 60	DPST-NO	
052164	42-23116-09	3	10 - 30	90 - 150/30 - 60	TPST NO	

Ruud Heating & AC Repair Parts

Sequencing Relay

- Flush mount plate w/ mounting hole & tab
- 1/4" Quick connects
- Heater Wattage/ Power Consumption:
24 VAC/.10A-.18A steady state/.35 - 1.0 amps peak for 0.8 sec



Part #	Mfg #	Poles	Sequencing Off	Sequencing On	Switching	Price
137087	PD425078	2	30 - 60	1 - 30	DPST-NO	
185861	425079	2	1 - 30	30 - 60	DPST-NO	

Service Valves

Service Valve

- Front seating valves, isolate sections of a system for servicing and provide a means for refrigerant charging
- All brass corrosion resistant body and solid copper fittings
- Includes 1/4 Flare SAE charge port; communicates with lower fitting when in closed position
- Suitable for R-22 and R-410A, 600 psig maximum working pressure



Part #	Mfg #	Connect	OPP Connect	OAL	Charge Port Location	Price
085196	61-21368-13	3/8" Sweat ODF	3/8" Sweat ODF	4-5/8"	Side	
101321	61-21368-07	3/4" Sweat ODF	3/4" Sweat ODF	5"	Bottom	
096123	61-21368-15	7/8" Sweat ODF	7/8" Sweat ODF	5"	Side	
083261	61-21368-16	7/8" Sweat ODF	3/4" Sweat ODF	5-1/8"	Side	

Service Valve



Part #	Mfg #	Description	Price
092122	803003	1/4" OD Service Valve	
143354	83-CD8403-6PK	3/16" OD Service Valve	

Miscellaneous

Remote Sensor for 90 Series®

- Digital signal output provides superior temperature control, even over long wire runs
- No temperature variance caused by wire resistance
- Choice of styling, indoor models are interchangeable
- Perfect for securing the thermostat in one area or room while sensing temperature in the conditioned space



**White
Rodgers**

Part #	Mfg #	Color	Dimensions	Model	Range	Price
102316	F145-1328	Classic White	2-1/8" x 3-1/2" x 3/4"	Indoor	40° to 99°F All Indoor Remote	
101726	F145-1378	Classic White	2-1/8" x 3-1/2" x 3/4"	Outdoor	-40° to 140°F	

Ruud Heating & AC Repair Parts

Mixed Air Sensor

Part #	Mfg #	Description	Price
076571	470010	Mixed Air Sensor	

Logic Module

Part #	Mfg #	Description	Price
143968	PD470009	Demand Control Ventilation Economizer Logic Module with Heat Pump Input	

Start Kit

- 330 VAC
- 60Hz



Part #	Mfg #	Description	Price
173840	SK-A1	Compatible with with RA13, RA14, RA16, RP14, RP15, UA17, & RJMA Units	

Repair Parts

Ruud Heating & AC Repair Parts

Pressure Switches

Pressure Control

Low Pressure Control - Auto Reset (Sweat w/o Cap Tube)



Part #	Mfg #	Description	Price
150872	47-101529-09	50 psig Open Pressure 5/16" Sweat Connection, 90° Elbow End	

High Pressure Control - Auto Reset (Sweat w/o Cap Tube)



Part #	Mfg #	Description	Price
113929	47-26184-01	610 psig Open Pressure 420 psig Close, 1/4" Swt Connection, Straight Fitting	

Pressure Control Switch



Part #	Mfg #	Description	Price
161588	42-101225-81	Pressure Switch	
091197	42-101233-81	Pressure Control	
091198	42-101443-89	Pressure Control, 0.45" WC	
091200	42-101443-91	Pressure Control, 0.60" WC	
091311	42-101444-83	Pressure Control, 1.00" WC	
091438	42-101445-83	Pressure Control, 0.40" WC	
083509	42-101447-07	Pressure Control	
098938	42-101447-86	Pressure Control, 1.80" WC	
107479	42-101447-89	Pressure Control, 1.95" WC	
091542	42-101511-84	Pressure Control	
128891	42-101955-02	Pressure Switch for RGRC034T 074T 105T	
137097	42-101955-08	Pressure Switch for RGRC Drain	
109677	42-101956-09	Pressure Switch for RGRC RGTC Vent	
109679	42-101956-10	Pressure Control, 1.20" WC	
128890	42-101956-12	Pressure Switch for RGRC Vent	
107812	42-102056-01	Dual Pressure Control, -0.80" & -1.30" WC	
112161	42-102056-02	Dual Pressure Control, -0.60" & -1.08" WC	
107814	42-102056-03	Dual Pressure Control, -0.86" & -1.20" WC	

Pressure Switches (Continued)

Pressure Control

Pressure Control Switch

Part #	Mfg #	Description	Price
125747	42-102056-05	Dual Pressure Control, -0.40" & -0.60" WC	
107813	42-102056-06	Dual Pressure Control, -0.66" & -1.30" WC	
123676	42-102056-13	Dual Pressure Control, -0.30" & -0.50" WC	
136527	42-102056-22	Dual Pressure Control, -0.40" & -0.30" WC	
145463	42-102056-25	Dual Pressure Control	
145462	42-102056-26	Dual Pressure Control	
145461	42-102056-27	Dual Pressure Control	
145460	42-102056-28	Dual Pressure Control	
160008	42-102069-01	Pressure Switch Assembly	
162413	42-102070-14	Pressure Switch Assembly	
127334	42-103193-01	Dual Pressure Control	
089690	42-24194-01	Pressure Switch	
091194	42-24194-82	Pressure Control	
080580	42-24195-03	Pressure Control, for UGRA UGFD 90RS 90RT	
135420	42-24195-81	Pressure Control, 0.50" WC	
080915	42-24196-81	Pressure Control, For UGRA UGFD 90RS	
083251	42-24196-82	Pressure Control	
083259	42-24196-83	Pressure Control	
081061	42-24196-84	Pressure Control	
082670	42-24197-01	Dual Pressure Control, -0.80" & -1.30" WC	
141506	47-103670-06	Low Pressure Control	
031417	47-21604-03	Pressure Switch	
138441	SP20313	Pressure Switch	

Ignition Controls & Other Boards

Control Boards

Part #	Mfg #	Description	Price
129524	47-100436-02	Control Board for X-13 Motor	
115784	47-102090-82	Control Board for UARL	
163875	47-102090-93	Control Board Kit - Communicating	
186557	47-102077-03	Control Board - ECM	
129219	62-102635-81	Control Board	
110554	62-102636-01	Integrated Furnace Control Board	
133313	62-102860-01	Integrated Control Board	
127527	62-103189-01	Integrated Furnace Control Board	
145473	62-103565-01	Integrated Furnace Control Board	

Repair Parts

Ruud Heating & AC Repair Parts

**Ignition Controls & Other Boards
(Continued)
Control Boards**

Part #	Mfg #	Description	Price
145475	62-103578-01	Inducer Control Board	
160036	62-104058-02	Integrated Furnace Control Board	
162408	62-104059-01	Integrated Furnace Control Board	
173548	62-104061-03	Integrated Furnace Control Board	
150560	62-23599-05	Integrated Furnace Control Board	
081759	62-24140-04	Integrated Furnace Control Board Direct Spark	
093116	62-24174-02	Modulating Control Board	
082900	62-24268-03	Hot Surface Igniter and Integrated Furnace Control	
115091	62-25338-01	Control Board	
071437	62-42506-02	Integrated Furnace Control Board	
033177	62-25341-81	Integrated Furnace Control Board	

Fan Control Board



47-22827-83

Part #	Mfg #	Description	Price
009374	47-22445-01	Fan Control Board	
009386	47-22827-83	Fan Control Board	
009378	47-22481-81	Fan Control Board	

Ignition Module



Part #	Mfg #	Description	Price
127446	620044	5059-134 Ignition Module White-Rodgers 24V Intermittent Pilot Ignition	

Ignition Control



Part #	Mfg #	Description	Price
086472	62-24181-01	Ignition Control/Direct Spark Ignition	

**Ignition Controls & Other Boards
(Continued)
Ignition Control**

Part #	Mfg #	Description	Price
053123	62-25078-02	Ignition Control	

Ignitors & Flame Sensors

Igniters



Part #	Mfg #	Description	Price
145476	62-103541-01	Hot Surface Igniter	
009550	62-21747-02	Igniter	
009563	62-22669-92	Igniter	
009574	62-22868-93	Igniter	
051183	62-23556-03	Igniter	
137901	62-23556-08	Direct Spark Igniter	
137712	62-23556-10	Igniter	
119752	62-23556-82	Igniter	
051711	62-24141-04	Direct Spark Ignition (DSI)	
160039	62-24141-05	Direct Spark Ignition (DSI)	
042260	62-24164-01	Direct Spark Ignition (DSI)	
166512	SP20794	NG Igniter with Gasket and Mounting Screws	

Flame Sensor



Part #	Mfg #	Description	Price
009582	62-23543-01	Flame Sensor Rod, 2-1/2"L Mnt Flg to Sensor Tip 1-9/16"L Sensor Offset 90° Angle Sensor Offset	
051177	62-23543-02	Flame Sensor Rod, 2-1/16"L Mnt Flg to Sensor Tip 1-13/16"L Sensor Offset 90° Angle Sensor	
128886	62-23543-06	Flame Sensor	
036437	62-24044-71	Non-Integrated w/ Mnt Brackets for Ribbon & Inshot Style Burners & 62-23543-01 Igniter	
141681	SP15129	Flame Sensor with Gasket and Mounting Screw	
144183	SP20172	Flammable Vapor Sensor Kit with Cap Plug	

Repair Parts

Ruud Heating & AC Repair Parts

Heat Exchangers

Heat Exchanger

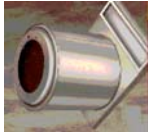

Primary

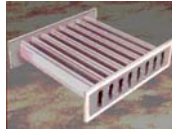

Secondary



Turbulex

Part #	Mfg #	Description	Price
142996	AS-59066-89	Heat Exchanger	
092267	AS-61805-16	Heat Exchanger Assembly	
083242	AS-61805-17	Heat Exchanger Assembly	
110398	AS-61805-20	Heat Exchanger Assembly	
093422	AS-61849-16	Heat Exchanger	

Traps & Connectors

Vent Transition

Part #	Mfg #	Description	Price
080464	68-24047-10	Vent Transition	

Condensate Trap Assembly



Part #	Mfg #	Description	Price
009615	68-24048-01	Condensate Trap Assembly	
080873	68-100651-01	Trap Assembly for UGRK	
021617	68-24021-01	Pipe-Outlet Air	
160002	68-104346-01	Condensate Drain	

Vent Termination Kit

• For gas furnace



Part #	Mfg #	Description	Price
135776	SP20245	Concentric Vent Termination Kit for 3" PVC	

Connection/Transition

Part #	Mfg #	Description	Price
025662	68-24047-08	Connection/Transition	
125740	68-103061-01	Connection/Transition Assy	

Trap



Part #	Mfg #	Description	Price
009603	68-22732-01	PVC Trap	
020322	68-24120-01	Horizontal Trap	

Trap Assembly Connector

Part #	Mfg #	Description	Price
022339	68-24047-07	Trap Assembly Connector	
022340	68-24047-09	Trap Assembly Connector	

Furnace Accessories

Gas Valve Conversion Kit

Part #	Mfg #	Description	Price
031644	60-21193-02	White Rodgers 36E Series LP to Natural Gas Kit	
166053	60-22513-04	Honeywell VR8205 Series Natural Gas to LP	
031639	60-23430-03	Robertshaw 7200 Series LP to Natural Gas Kit	
058453	FP-15	Conversion Kit NAT/LPG	
151024	FP-31	HK LP Conversion Kit	
158962	FP-33	JC LP Conversion Kit for 1-Stage	
158963	FP-34	LP Conversion Kit for 2-Stage	
177590	FP-36	JR LP Conversion Kit for 1-Stage	
185112	FP-37	LP Conversion Kit	
158961	RXGY-ZK	Zero Clearance Downflow Conversion Kit	

Filter Cores

Filter Core

Part #	Mfg #	Description	Price
149940	83-F48	Filter Core	
149943	83-H48	Filter Core	
149941	83-W48	Filter Core	
149942	83-W100	Filter Core	

Repair Parts

Ruud Heating & AC Repair Parts

Solid Furnace Bottoms



Part #	Mfg #	Description	Price
073627	AE-61874-01	AE-61874-01 Solid Bottom 14"	
022627	AE-61874-02	AE-61874-02 Solid Bottom 17"	
022628	AE-61874-03	AE-61874-03 Solid Bottom 21"	
073628	AE-61874-04	AE-61874-04 Solid Bottom 24"	

Pilots & Orifices

Orifice



Part #	Mfg #	Description	Price
049438	62-22175-50	Orifice	

Pilot



Part #	Mfg #	Description	Price
009572	62-22864-82	Pilot	

Pilot Burner



Part #	Mfg #	Description	Price
038148	62-21609-01	Pilot Burner	

Pilot Orifice



Part #	Mfg #	Description	Price
009543	62-21489-01	Pilot Orifice	
009545	62-21612-02	Pilot Orifice	
009548	62-21743-05	Pilot Orifice	
009552	62-21883-01	Pilot Orifice	

Pilot Safety



Part #	Mfg #	Description	Price
009540	62-21426-02	Pilot Safety	

Pilot Sensor



Part #	Mfg #	Description	Price
009549	62-21744-01	Pilot Sensor	
160037	62-23543-08	Flame Sensor	

Drain Pans

Drain Pan

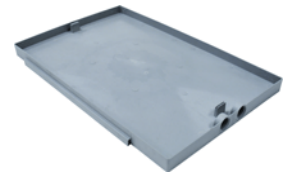

Part #	Mfg #	Description	Price
229624	68-101805-81	14" 4-Row Drain Pan	
159621	68-101805-82	17" Drain Pan Vertical 6 Row	

Door Switches

Door Switch



42-21268-04

Part #	Mfg #	Description	Price
050499	42-21268-04	Door Switch	
123748	42-22692-06	Push Button Door Switch	
125543	42-22692-09	Door Switch	
160012	42-22692-10	Door Switch	

Repair Parts

Ruud Heating & AC Repair Parts

Burners

Part #	Mfg #	Description	Price
035443	75-22840-02	Burner Tube - Inshot	
028110	75-24001-01	Burner Head Kit	
061420	AS-60993-03	Burner Halves Assembly	
103698	AS-60993-06	Burner	
043357	AS-61984-04	UGRA 1-Pc Burner	
043358	AS-61984-05	UGRA 1-Pc Burner	
043359	AS-61984-06	UGRA 1-Pc Burner	
043360	AS-61984-07	UGRA 1-Pc Burner	
043361	AS-61984-08	UGRA 1-Pc Burner	

Burner Support

Part #	Mfg #	Description	Price
111992	AE-61809-15	Burner Support	
109627	AE-61809-12	Burner Support	

Anti-Vibration Pads

EVA Anti-Vibration Pad

- 2"x2"x7/8"



Part #	Mfg #	Description	Price
156821	864011	2"x2" Anti-Vibration Pad	
156822	864013	4"x4" Anti-Vibration Pad	

Miscellaneous

Blower Parts

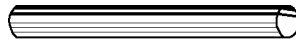

Part #	Mfg #	Description	Price
102437	70-42540-04	1" Shaft	

Choke



Part #	Mfg #	Description	Price
053006	46-23585-01	Power Factor Choke	
052335	46-24256-02	Power Factor Choke	

Tubing



Part #	Mfg #	Description	Price
020713	79-21491-83	Silicone Tubing	
162989	79-24182-83	Santoprene Tubing, 31-1/2"L, 2 Hose Clamps	

Sheath Heater Kit

Part #	Mfg #	Description	Price
037996	AS-58386-92	Sheath Heater Kit 3.5kW	

Solenoid Assembly

Part #	Mfg #	Description	Price
044160	61-25055-08	24V Solenoid Assembly	

Bearing



Part #	Mfg #	Description	Price
097430	70-41854-02	Ball Bearing With Lock	

OEM Neoprene Gasket

- Suitable for temperature range of -70° to 250°F
- Meets UL94HFI and UL94HBF flammability tests



Part #	Mfg #	Description	Price
059148	68-22079-81	1-1/8"W 25'L 5/16" Thick	

Replacement Parts and Accessories

Part #	Mfg #	Description	Price
111991	AE-61913-02	Overtemperature Switch Bracket	
145536	SP14410	Piezo Igniter with Bracket	
160006	68-104446-01	Parts Bag	
162200	45-22980-05	Button Plug	
107681	1000	FAST-STAT Wire Extender	
161388	AS-58922-01	Turbulator	

Repair Parts

Ruud Heating & AC Repair Parts

**Replacement Parts and Accessories
(Continued)**

Part #	Mfg #	Description	Price
168203	6231	Cold Weather Kit - GEN15ADC-E, GEN16AD-E, GEN20AD-E	

Repair Parts

Ruud Heating & AC Repair Parts

Ruud Accessories

RXCT - Expansion Valve Conversion Kit

- Use to convert RCBA indoor coils to RCGA/RCGJ/RCHA and RCHJ coils



Part #	Mfg #	Description	Price
132107	RXCT-FBA	R410 Universal TXV Repl Kit	
133834	RXCT-EBA	TXV R22 Universal 2 Ton	
132108	RXCT-FBB	R410 Univ TXV Repl Kit	
132109	RXCT-FBC	Expansion Valve Kit	
132110	RXCT-FBD	TXV Universal Kit	

Controls

Part #	Mfg #	Description	Price
173851	RXAB-A07	High Pressure Control	
173850	RXAC-A07	Low Pressure Control	
130488	RXRZ-C02	Low Ambient Control	

RXGF - Media Air Cleaner



Part #	Mfg #	Outside Dimensions	Price
132422	RXGF-CB	Bottom Mount 24-1/4"W x 28-1/4"L x 3-1/2"H	
020727	RXGF-CC	Top Mount Filter Rack - Gas Downflow	
158964	RXGF-CD	Side Return Filter Rack - Gas Upflow	

External Filter Rack

- Upflow - Electric
- Duct configuration: Through
- Air opening inlet/outlet: 15-3/4" x 19-1/2"
- Housing overall: 17-1/2" x 21" x 3-5/8"
- Hinged door - opening on 17-1/2" side
- Replacement media dimensions: 16" x 20"



Part #	Mfg #	Description	Price
147301	RXHF-17	External Filter Rack - Electric Upflow	

RXMG - Label Kit

Part #	Mfg #	Description	Price
105390	RXMG-AU	Ruud Label Kit	
127216	RXMG-AY	WeatherKing Label Kit	

RXBH - Heater Kit



Part #	Mfg #	Description	Price
133645	RXBH-1724A18J	18kW 208-230/1/60	

Repair & Replacement Parts

Drain Trap

Part #	Mfg #	Description	Price
125544	791000	Tubing Drain Trap	
125548	791001	Tubing Drain Trap	

Fan Blade Puller

Part #	Mfg #	Description	Price
149962	UP-1	Fan Blade Blower Wheel Puller	

Gas Valve



Part #	Mfg #	Description	Price
009506	60-22525-03	Gas Valve	
009507	60-22525-04	Gas Valve	
145471	60-102787-01	Gas Valve	
009508	60-22525-05	Gas Valve	

Ignition Control



Part #	Mfg #	Description	Price
034342	62-24084-82	Ignition Control Board	

Repair Parts



Ruud Heating & AC Repair Parts

Igniter



Part #	Mfg #	Description	Price
137361	AP14698B	NG Igniter Assembly	
137360	AP14700B	LP Igniter Assembly	

Vent Damper



Part #	Mfg #	Description	Price
145411	AP15561	Vent Damper	



Furnace Accessories

Ruud Furnaces Accessories

RXGP - Twinning Kit

Part #	Mfg #	Description	Price
138545	RXGP-F03	For Use w/Gas Furnaces for Parallel Operations	

ERV/HRV - Vent Termination Kit

Part #	Mfg #	Description	Price
155994	84-ERVHRV	HEPA Vent Termination	

RXGY - Vent Termination Kit

- For gas furnace

Part #	Mfg #	Description	Price
087666	RXGY-G01	Horizontal Vent Termination for 3" PVC	
097398	RXGY-G02	Horizontal Vent Termination for 2" PVC	
158960	RXGY-CK	Downflow/Horizontal Conversion Kit	
155961	RXGY-ZK	Zero Clearance Downflow Conversion Kit	

RXPF - Fossil Fuel Kit

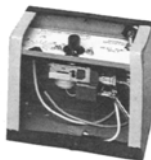

Part #	Mfg #	Description	Price
032692	RXPF-F01	Fossil Fuel Kit - Standard	

RXRY - Filter Kit

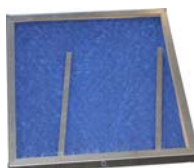

Part #	Mfg #	Description	Price
085898	RXRY-B01	For Vertical or Horizontal Discharge in RQKA & RQMA	

Furnace Repair & Replacement Parts

Conversion Kit - NG - LPG

Part #	Mfg #	Description	Price
025489	FP-02	Nat-LP Conversion Kit	
058453	FP-15	Nat-LP Conversion Kit	

Furnace Repair & Replacement Parts (Continued)

Conversion Kit - NG - LPG

Part #	Mfg #	Description	Price
100705	FP-21	Nat-LP Conversion Kit	
121685	FP-26	Nat-LP Conversion Kit	
129578	FP-27	Nat-LP Conversion Kit	
074120	60-21193-01	Nat-LP Conversion Kit	
083260	60-22513-03	Nat-LP Conversion Kit	
031641	60-23430-01	Nat-LP Conversion Kit	

Repair Parts

Ruud Heating & AC Repair Parts

Motors

Motor Mount - Flex Bracket

- Torsion flex bracket



Part #	Mfg #	Description	Price
139342	DMB-3	Fits 5-1/2" Diameter Motors	

Multiple Horsepower Blower Motor

- Reversing plugs
- Extended thru bolts
- 36 inch leads
- Designed for 370 volt capacitors.
- Installs with all 48 mounting brackets.



Part #	Mfg #	Description	Price
198034	WG840463	1/6-1/2 HP-FLA 115V Blower Motor	
198035	WG840464	1/6-1/2 HP-FLA 208-230V Blower Motor	
198036	WG840466	1/5-3/4 HP-FLA 115V Blower Motor	
198037	WG840467	1/5-3/4 HP-FLA 208-230V Blower Motor	

Multiple Horsepower Condenser Fan Motors

- Reversing plugs
- Extended thru bolts
- 36 inch leads
- Designed for 370 volt capacitors
- Installs with all 48 frame mounting brackets.



Part #	Mfg #	Description	Price
198038	WG840465	1/6-1/3 HP-FLA 208-230V Condenser Fan Motor	
198039	WG840468	1/5-1/2 HP-FLA 208-230V Condenser Fan Motor	
198040	WG840469	1/6-1/2 HP-FLA 208-230V Condenser Fan Motor	

Direct Drive Furnace Blower Motors

- Installed with standard 48 frame mounting brackets
- Quiet operator and electrically reversible
- Automatic Thermal Overload Protector
- Class B insulation
- 30in. leads and 60 HZ with low power consumption
- Standard 48 frame motor casing size
- Drain holes with plugs on both end plates
- Continuous air over
- 60 C Ambient Design with Extended Studs.



Part #	Mfg #	Description	Price
198021	WG840583	1/4 HP 4.6 FLA 115V Blower Motor	
198022	WG840584	1/4 HP 2.2FLA 208/230V Blower Motor	
198023	WG840585	1/3 HP 6.7 FLA 115V Blower Motor	
198024	WG840586	1/3 HP 2.9 FLA 208/230V Blower Motor	
198025	WG840587	1/2 HP 10.2 FLA 115V Blower Motor	
198026	WG840588	1/2 HP 5.0 FLA 208/230V Blower Motor	
198027	WG840589	3/4 HP 11.3 FLA 115V Blower Motor	
198028	WG840590	3/4 HP 5.4 FLA 208/230V Blower Motor	
206600	WG840595	1HP 12.6 FLA 115V Blower Motor	

Single Speed Condenser Fan Motors

- Installs with all standard 48 frame mounting brackets
- Quiet operator and electrically reversible
- Includes Automatic Thermal Overload Protector
- Class B insulation
- 370V Capacitor
- Standard 48 frame motor casing size
- 2.5in. diameter hub rings included.



Part #	Mfg #	Description	Price
198029	WG840727	1/6 HP 1.3 FLA 208/230V Condenser Fan Motor	



Ruud Heating & AC Repair Parts

Motors (Continued)

Single Speed Condenser Fan Motors

Part #	Mfg #	Description	Price
198030	WG840728	1/4 HP 2.2 FLA 208/230V Condenser Fan Motor	
198031	WG840729	1/3 HP 2.8 FLA 208/230V Condenser Fan Motor	
198032	WG840730	1/2 HP 4.2 FLA 208/230V Condenser Fan Motor	
198033	WG840731	3/4 HP 4.5 FLA 208/230V Condenser Fan Motor	

Water Right Repair Parts

Installation Fittings

Part #	Mfg #	Description	Price
126558	CV-3007	1" PVC Male NPT 90° Assembly	
066030	CV-3007-02	1" Brass Sweat Assembly	
066031	CV-3007-03	3/4" Brass Sweat Assembly	
134871	CV-3007-12	3/4" Shark Bite Assembly	
129386	CV-3150	Split Ring	

Replacement Parts

Part #	Mfg #	Description	Price
075129	CH1072-01	18" dia Salt Grid with 4" Hole	
073577	FP-60049	Plastic Bypass Assembly	
074255	CS-1448-RS	35 gal Replacement Membrane for WRO035	

Accessories

Part #	Mfg #	Description	Price
101608	HT-5B	Water-Right Hardness Kit	
113671	FP60066	Brine Valve Water-Right	
148693	CU7002	Water Sample Bottle	
150670	RO12N	1.5# Softener Rust Out	
099934	VA-2	Better Air Gap	

Watts Regulator Repair Parts

Dielectric Union Kits

3000 Series Dielectric Union Gasket Kit

Part #	Mfg #	Model	Size	Price
030973	0881401	GAB KIT	3/4"	
030972	0881402	GAC KIT	1"	
030971	0881403	GAD KIT	1-1/4"	
030970	0881404	GAE KIT	1-1/2"	
030969	0881405	GAF KIT	2"	

Weil McLain Repair Parts

Weil-McLain Boiler Parts & Components

Part #	Mfg.#	Description	For	Price
110792	382-200-449	Conversion Kit, NG, from Cycle Pilot System to Gold control HSI		
011885	382-930-216	10C523 Igniter Kit	VHE, HE II	
076751	383-500-345	Repair Plug Kit		
128037	383-500-603	(5) Ultra U-Control Module Fuses, 3A, Fast-Blow AG	F1	
145731	383-500-604	(5) Ultra U-Control Module Fuses, 12A, Slow-Blow AG	F2	
129778	383-500-622	Heat Exchanger Replacement Kit	230	
129779	383-500-623	Heat Exchanger Replacement Kit	310	
128030	383-600-069	Low Water Cut-Off		
076395	389-900-203	WMCR-3 3 Zone Circulator Control		
045038	389-900-205	6 Zone Circulator Control		
138955	389-900-206	WMZV-4 4 Zone Valve Control		
136985	389-900-220	BCP-3 Hydronic Multi-Stage Boiler Control Panel		
011893	510-218-099	10C034 Tridicator Gauge, 2-1/2" Short Shank	GV, GO, CG Prior to Jan 2000	
101982	510-300-014	210°C Spill Switch with Reset	CG Sect/Base Series 1-12	
127719	510-312-015	High Limit Temperature Control	HE II, HE, VHE	
011899	510-312-166	10C053 Combination 120/24V Transformer-Relay Receptacle	CG, AHE, EGH, HE II, HE, PFG	
116334	510-312-218	Outdoor Temp Sensor		
038133	510-312-250	10C055 Limit Control & 1/2" Well	CG, CGm, EGH, PFG	
021051	510-312-312	10C567 Blower Motor Assembly	HE II, HE	
011904	510-312-317	10C579 Motor Repl Kit	VHE	
011909	510-350-223	10C072 Control Relay, DPST 24V	AHE, CG, EG, EGH, HEII, PFG	
032886	510-811-221	Pilot Assembly NG		
032887	510-811-222	Pilot Assembly Propane		
011913	510-811-362	NG-LP Conversion Kit	CG 25 - 6	
107651	510-811-502	24V Combination Ignition-Sensing Control Module		
022497	510-811-644	Pilot Assembly Kit		
011922	510-811-655	10C528 NG Valve	HE, HEII, VHE	
011923	510-811-656	10C529 Step Open LP Gas Valve	HE, HEII, VHE	
044138	511-044-382	Gas Valve 3/4" x 3/4" NG 10C489		
078890	511-114-479	63m Low Water Cut-off		
078891	511-114-526	w/McLain LWCO 150smd M&M 17180 672619142831		
059929	511-330-081	LP Pilot Burner Assembly		
011934	511-330-095	Ignition Module 10C486	CG, EG, EGH, PFG	
019926	511-330-184	Igniter Only 10C455	HE/VHE	
011943	511-330-186	Pilot Burner Assembly		
011944	511-330-192	Flame Sensor 10C188	HE, VHE	
011945	511-330-197	Pilot Burner	E38-2 24V	
073640	511-330-218	Pin Pilot Burner 10C481	CG	
064739	511-330-221	Pilot Burner Assembly with Ignition Lead and Orifice PSE-NA16		
011947	511-624-510	Switch .95 Pressure Switch 3-5 2, 000'-4, 000' 10C213	HE	
011948	511-624-514	Pressure Switch 51.2 Pressure Switch VHE 2000'-4000' 10C215		
074480	511-724-259	Thermopile for EG-75		
038426	511-724-274	Main Flame Sensor		
011956	512-050-230	Thermal Fuse 10C257	CG, EG, HE, PFG, VHE	
056344	512-200-000	Steel Burner Tube		

Repair Parts

Weil McLain Repair Parts

Weil-McLain Boiler Parts & Components (Continued)

Part #	Mfg.#	Description	For	Price
056346	512-200-001	Steel Burner Tube with Bracket		
118676	512-200-035	Burner	HE VHE CGI	
011958	512-200-045	Pilot Burner 10B867		
127431	540-131-052	X100 Sentinel Corrosion Inhibitor Kit		
127432	540-131-053	X100 Sentinel Corrosion Inhibitor Kit		
127433	540-131-054	X100 Sentinel Corrosion Inhibitor Kit		
011968	560-742-860	Pilot Tubing		
020911	590-317-610	Blower Gasket		
015274	590-735-140	1/2" x 100" Glass Rope 10B985		
086820	591-200-000	Cover Plate Gasket/Insulation		
114285	591-706-200	Heat Exchanger Cleaning Tool		
011981	591-706-214	Flue Brush 11B146		
011985	592-800-011	2" Square Cut Seal		
127434	592-900-002	Sentinel X-100 Corrosion Inhibitor Concentrate		
127632	592-900-003	X400 Cleaner		
059875	633-900-102	Thermostat with Cover Plate Kit for Plus Water Heaters		
094665	633-900-130	Gold Plus Thermostat Kit		
011986	635-100-010	Kit Thermostat Plus		

Vent Damper

Part #	Mfg.#	Description	Price
019945	381-800-474	4" Vent Damper	
019946	381-800-475	10C081 5" Vent Damper for EG30/35	
019944	381-800-476	6" Damper Assembly CGM,EG	
019947	381-800-477	7" Damper Assembly CGM,EG,PFG	
030770	381-800-478	10C478 8" Vent Damper for EG65/75	

CGa Series Accessories

Part #	Mfg.#	Description	For	Price
146736	381-357-313	Pilot less Ignition for Natural Gas Boilers	CGa-8	
049683	450-021-245	CGa-7 Draft Hood Vertical		
032392	450-021-246	CGa-8 Draft Hood Vertical		
050610	512-200-077	CGa Main Stainless Steel Burner Tube		
065995	512-200-079	CGa Stainless Steel Burner with Pilot Bracket LP		

CGi Series Accessories

Part #	Mfg.#	Description	For	Price
058742	511-330-090	Control Module with 10 Second Pre-purge		
064887	510-312-167	Transformer		
059928	511-330-080	Pilot Assembly Kit NG		

Weil McLain Repair Parts

CGm Series Accessories

Part #	Mfg.#	Description	For	Price
041152	511-044-256	NG Valve	CGm 7-8	

CGs Series Accessories

Part #	Mfg.#	Description	For	Price
017582	311-103-818	Intermediate Section Assembly		
059940	381-356-499	Inducer Fan Assembly Kit		

CGt Series Accessories

Part #	Mfg.#	Description	For	Price
112055	380-000-000	Combination Pressure-Temperature Gauge Kit, 60° - 360°F	CGt Series	

PFG Series Accessories

Part #	Mfg.#	Description	For	Price
011912	510-512-337	Vent Damper Motor Operator		
024710	511-044-287	NG Control Valve, 1" x 1" NPT	PFG	

Ultra Series Accessories

Part #	Mfg.#	Description	For	Price
109058	383-500-021	Time Delay/Relay Box		
066027	383-500-025	Gas Valve Kit	Ultra 155	
066028	383-500-030	Gas Valve/Venturi Kit	Ultra 230	
066022	383-500-035	Blower Assembly	Ultra 155	
066024	383-500-040	Blower Assembly	Ultra 230	
066039	383-500-045	Ignition Electrode Kit	Ultra 80 & 105	
066042	383-500-055	Flue Temperature Sensor Replacement Kit		
066040	383-500-085	Burner Replacement Kit	Ultra 155	
130501	383-500-095	Watts #330 300 psi Pressure Relief Valve, ASME		
120566	383-500-105	3" Vent Termination Bird Screen	Ultra 80, 105, & 155	
105545	383-500-110	4" Vent Termination Bird Screen	Ultra 230 & 310	
066021	383-500-125	Outdoor Temperature Sensor		
066016	383-500-190	Ultra Control Module	Ultra 80, 105, 155, & 233	
066017	383-500-195	115VAC / 24VAC, 50-60Hz, 50 VA Honeywell Transformer		
066020	383-500-200	Honeywell Display Board & Bracket Assembly		
093857	383-500-210	Pressure/Temperature Gauge Assembly		
143606	383-500-235	5 Amp Fast-Blow Fuses	Circulator Circuit 5/Pk	
143607	383-500-240	4 Amp Slow-Blow Fuses	24-Volt Circuit 5/Pk	
086818	383-500-250	Cover Plate Gasket/Insulation	Ultra 155, 230, & 310	
086819	383-500-255	Cover Plate Gasket	Ultra 155, 230, & 310	
074417	383-500-360	Blower Assembly Kit	Ultra 310	
074418	383-500-390	Gas Valve/Venturi Kit	Ultra 310	
133205	383-500-395	Cover Plate Replacement Kit	Ultra 155 & 230	
116337	383-500-408	Display Board/Bracket Assembly	Ultra 155/230	
121565	383-500-600	Flue Temperature Sensor Replacement Kit		
116333	383-500-601	System Temperature Sensors		

Weil McLain Repair Parts

Weil-McLain Boiler Parts & Components (Continued) Ultra Series Accessories

Part #	Mfg.#	Description	For	Price
116331	383-500-602	Return/Supply Sensor Kit, (1) Sensor		
120435	383-500-605	Maintenance Kit	Ultra 80 and 105	
120436	383-500-620	Maintenance Kit	Ultra 155, 230, 299, & 399	
129776	383-500-621	Heat Exchanger Kit	Ultra 155	
120152	383-500-628	120V/24V Transformer		
133206	383-500-630	Pressure/Temperature Gauge Assembly		
130577	383-500-649	Ultra Easy-Up Manifold Kit, 1-1/4" Piping	UG 80 & 105	
133204	383-500-650	Blower Assembly Kit	Ultra 399	
133203	383-500-652	Gas Valve Kit	Ultra 399	
127630	383-500-658	Control Module		
127885	383-500-659	Display Board Assembly		
130578	383-500-661	Ultra Easy-Up Manifold Kit, 1-1/2" Piping	UG 155-399	
074410	383-501-027	Blower Assembly Kit	Ultra 80 & 105	
074411	383-501-029	Gas Valve/Venturi Kit	Ultra 80	
074413	383-501-030	Gas Valve/Venturi Kit	Ultra 105	
125176	511-100-005	LWCO with Harness & Test Button		
090744	511-405-133	Taco 0014 Boiler Circulator, less Flanges	Ultra 155, 230, & 310	
107709	590-317-310	Gasket Cork		

Ultra Commercial Series Accessories

Part #	Mfg.#	Description	For	Price
127629	383-600-065	Watts 174A 80 psi Relief Valve, 3/4" x 3/4", 1,400 mbh Capacity		
143176	383-600-079	Maintenance Kit		

WM97+ Series Accessories

Part #	Mfg.#	Description	For	Price
146863	383-700-113	Igniter, Gasket and Screw	WM97+ 70 & 110	
146859	383-700-139	Ignition Control	WM97+ 70 & 110	
146870	383-700-157	Piping Assembly Blower & Clip	WM97+ 70 & 110	
146871	383-700-159	Piping Assembly Gas Valve	WM97+ 70	
146872	383-700-160	Piping Assembly Gas Valve	WM97+ 110	
146860	511-724-292	Flue Sensor	WM97+ 70 & 110	
146861	511-724-296	Water Temperature Sensor	WM97+ 70 & 110	
146864	511-802-015	50VA Transformer	WM97+ 70 & 110	

GV Series Accessories

Part #	Mfg.#	Description	For	Price
011874	382-200-325	Burner Replacement Kit	GV4 & GV90+4	
011875	382-200-330	Burner Replacement Kit	GV5 & GV90+5	
011877	382-200-340	Blower Assembly		
011878	382-200-345	Blower Motor Kit 10C380		
011879	382-200-350	Vent 90 10C387		
011881	382-200-375	Switch Kit 10C403	GV90	

Weil McLain Repair Parts

Weil-McLain Boiler Parts & Components (Continued) GV Series Accessories

Part #	Mfg.#	Description	For	Price
011882	382-200-385	Hose Trap Kit		
030451	382-200-410	Boiler Gas Valve 10C399		
065429	382-200-411	Gas Valve Kit GV Series 4		
043582	382-200-448	Ignition Control Module (GV Series 1,2&3) 10C400		
011896	510-312-019	10C411 Limit Control		
050453	510-312-021	Limit Control w/1/2" Well	GV Ser 1, 2, 3 Sect Assy	
011941	511-330-148	Ignition Kit 10C402		
011949	511-624-520	Pressure Switch 10C382	GV	
011955	511-842-370	Transformer 10C401	GV	

EG/EGH Series Accessories

Part #	Mfg.#	Description	For	Price
035079	381-800-677	EG75 SPDN Boiler Water Trim No Tankless Option		
035078	381-800-675	EGH-30 to 65 Water Trim		
011892	510-218-097	10C526 Tridicator, 2-1/2" Long Shank	EG Series 1-4 Section Base Assy	
074482	511-724-255	36" Thermocouple with Spade Terminal Block	EG 75, EGH 85 & 95	
011966	560-528-985	LP Gas Pilot Orifice		
074479	590-850-561	5" Lead Wire	EG 75	

Sentinel Series Accessories

Part #	Mfg #	Description	Price
127435	592-900-005	Sentinel X100 Quik Test Kit	

Ultra Oil Accessories

Part #	Mfg #	Description	Price
066035	383-500-300	Water Temperature Sensor Kit	
066012	389-900-180	Wall Mount Kit	

Westinghouse/Philco Repair Parts

Blower Wheels

Part #	Mfg #	Description	Price
119974	667207	10-3/4" x 10", CW	
119975	667251	10" x 6", CW	
119976	667258R	11" x 8", CCWLE	
119977	667280	11" x 10", CCW	
119979	667374	11" x 8", CW	

Burners

Part #	Mfg #	Description	Price
134174	660921	Burner L1	
134173	661128	Inshot Burner G7T	

Capacitors

Part #	Mfg #	Description	Price
146433	01-0024	10mfd, 370V Round Capacitor	
119928	622135	15mfd, 370V Round Motor Capacitor	
136994	622545	10mfd, 370V Round Capacitor	

Contactors

Part #	Mfg #	Description	Price
139778	621661	25A, 1-Pole	
139779	621662	35A, 1-Pole	

Control Boards

Part #	Mfg #	Description	Price
133371	904531	Board All Units	
129223	920915	Control Board G7	
130336	920916	Control Board G7	
128774	920920	Board Direct Torque	

Control Modules

Part #	Mfg #	Description	Price
139792	624651	Comfort Alert Module New	
120743	903106	Control Module for G4 G5 G6 Models	

Defrost Boards

Part #	Mfg #	Description	Price
147380	920338	Defrost Board Adaptive	

Door Switches

Part #	Mfg #	Description	Price
119950	632125	Door Switch	

Fan Blades

Part #	Mfg #	Description	Price
139796	667261	Fan Blade	
139797	667318	Fan Blade f/S3QC Series 3 Ton Only	
139784	667319	Fan Blade 2 Blade 24 OD 27p CW 1/2 1200	
139783	667351	Fan Blade 2 Blade 24 OD 25p CW 1/2	
139798	667383	24" CW 3W 20° Fan Blade	

Flame Sensors

Part #	Mfg #	Description	Price
120728	903600	Flame Sensor (old #632396)	

Igniters

Part #	Mfg #	Description	Price
120726	903758	Replacement Igniter Kit	
134164	921074	Igniter Replacement Kit G7/GC2	
119987	904839	Igniter Assembly for G7 (New# Is 921074)	

Limit Controls

Part #	Mfg #	Description	Price
120741	626350	Vent Limit 260°F	
120733	626418	Limit 150/20°F	
120735	626419	Limit 195/20°F	
120736	626425	Limit 210/20°F	
120734	626434	3" Limit 180/20°F	
120749	626435	Limit 220/20°F	
120737	626449	3" Limit 250/20°F	
120744	626461	Vent Limit 160°F	
136184	626522	Main Limit Switch	
119934	626541	Switch Blower Limit G7	
119941	626561	Main Air Limit G7	
119945	626563	Main Air Limit G7	
145504	626598	Main Air Limit SD054, 072	
144772	626599	Limit Switch 1/2d,1s, or 16	
145498	626611	Blower Limit KG7SD	

Westinghouse/Philco Repair Parts

Lineset Fittings

Part #	Mfg #	Description	Price
131551	664378	Liquid Lineset Fitting	

Motors

Part #	Mfg #	Description	Price
139793	621952	A/C Fan Motor	
139795	621917	Fan Motor for FS3BA048	
139794	621919	PSC K 1/10 6p 1-Spd CWLE Fan Motor	
139788	622018	PSC 1/4 hp CWLE Fan Motor for 15 SEER	
139782	622066	PSC K 1/4 hp CWLE 6p 1-Spd Fan Motor	
139781	622080	1/4 hp CWLE Fan Motor	
139780	622171	.05 hp CWLE 2 Ton Motor	
130637	622264	Blower Motor 1/2hp 3-Spd	
143885	904502	Motor 1/3 3-Spd 115V	
120723	903111	Venter Motor 80% With Gasket	
134163	903962	Venter Motor w/Gasket	
134161	904085	Venter Motor GL1RC	
135437	903404	Inducer Motor	
119983	904796	Inducer Motor G7	
119985	904798	Inducer Motor G7	
119991	904857	Blower Motor G7	
119992	904858	Blower Motor G7	
119993	904859	Blower Motor G7	
119994	904860	Blower Motor G7	
141161	921651	3/4 hp High Efficiency Blower	

Orifices

Part #	Mfg #	Description	Price
149071	664067	Orifice #67	
149073	664071	Orifice #71	

Pressure Switches

Part #	Mfg #	Description	Price
120746	632302	Pressure Switch Vent for G6D	
139791	632393	Low Pressure Switch 39" (5CO-20CI) 632393	
120780	632444	Pressure Switch NO 1.75 Close 1.55 Open	
139785	632473	High Pressure Switch	
119953	632484	Sensor Flame G7	
119954	632487	Pressure Switch	
119955	632489	Pressure Switch G7	

Pressure Switches (Continued)

Part #	Mfg #	Description	Price
119956	632491	Pressure Switch Condensate G7	
119958	632493	Pressure Switch Inducer G7	
119960	632499	Pressure Switch G7	
119961	632514	Pressure Switch G7 Variable Speed Downflow	
119962	632515	Pressure Switch G7 Variable Speed Downflow	
119963	632516	Pressure Switch	
119966	632521	Pressure Switch G7	
134165	632546	Pressure Switch Inducer 1.0 for FG7TC	
134168	632547	Pressure Switch G7 Fixed Condensate	
134166	632548	Pressure Switch	
134167	632550	Pressure Switch G7	
134169	632554	Pressure Switch	
130948	632561	Pressure Switch for Fg7	
130950	632563	Pressure Switch for Fg7	
130951	632565	Pressure Switch for Fg7	
130952	632567	Pressure Switch for Fg7	
130953	632594	Pressure Switch 40 Close .20 Open Long Run for iQ Furnace	
122723	632571	Pressure Switch G7	
134010	632585	Pressure Switch	
145499	632622	Pressure Switch for M7	
145500	632624	Pressure Switch for M7	

Relays

Part #	Mfg #	Description	Price
139790	621931	Relay Blower	

Restrictors

Part #	Mfg #	Description	Price
149069	664048	1.5T Restrictor .048	
149070	664056	2T Restrictor .056	
149072	664061	2.5T Restrictor .061	
149074	664076	4T Restrictor .076	

Roll-out Switches

Part #	Mfg #	Description	Price
120731	626343	Switch Roll-out 300f	
119938	626558	Roll-out Switch G7	
119939	626559	Roll-out Switch G7	
119940	626560	Roll-out Switch G7	

Westinghouse/Philco Repair Parts

Roll-out Switches (Continued)

Part #	Mfg #	Description	Price
145497	626609	Roll-out Switch SD038	
145505	626610	Roll-out Switch SD054,072	

Transformers

Part #	Mfg #	Description	Price
134170	622341	Transformer 40VA/120/24	
134175	622396	Transformer 60 VA for 23 SEER Coil	

Tubing

Part #	Mfg #	Description	Price
119925	263967	High Temperature Tubing 3/16 36" Long	

Valves

Gas Valve

Part #	Mfg #	Description	Price
119930	624652	Gas Valve 2-Stage for TC TI G7	
130954	624703	Gas Valve for iQ Furnace	
143845	624787	Gas Valve 2-Stage for Fg7	
143844	904081	Gas Valve	
144173	921691	Gas Valve Kit with Harness	

Service Valves

Part #	Mfg #	Description	Price
139777	663862	Valve Liquid 3/8"	
139786	663864	Valve Suction 3/4" for FS5BD18-36	
133428	663963	Valve Ball 7/8" for FS4BD48-60, FT4B42-6	

TXV Valves

Part #	Mfg #	Description	Price
134244	669681	TXV for C6BAX24	
134245	669682	TXV for C6BAX30	
134246	669683	TXV for C6BAX35 And 36	
134247	669684	TXV for C6BAX42	
134250	669686	TXV for C6BAX60	
134249	669852	TXV R-410A 4.0 Ton	

Parts & Repair

Part #	Mfg #	Description	Price
119951	632261	3 Amp Fuse	

Parts & Repair (Continued)

Part #	Mfg #	Description	Price
119952	632269	5 Amp Fuse	
119981	664435	Drain Assy Upflow/Inline	
145506	664659	PVC Trap KG7SD	
134162	904573	Inducer for 95% With Gasket	
119986	904799	Blower Kit Inducer G7 Var Sp Downflow	
134073	904945	Repair Kit for G7 2-Stage 90%	
143415	904986	Replacement Parts Kit	
130955	904800	Induced Draft Blower FG7MQ	
131416	920994	Blower Control, Cons CFM, Vs Downflow	

Woodford Repair Parts

Yard Hydrant Repair Parts

Part #	Mfg #	Description	Price
011648	10009	Upper Link for Y34/Y1/Y2	
011649	10011	Reducing Coupling for Y1/Y2/Y34/W34	
011658	10100	Packing Nut for Y1/Y2/Y34/W34	
011659	10101	Packing for Y1/Y2/Y34/W34	
011660	10102	Packing Support Washer for Y1/Y2/Y34/W34	
011662	10104	Brass Rod Stem for Y1/Y2/Y34/W34	
011678	15003	3/4 Head Assembly	

Nozzle

Part #	Mfg #	Description	Price
011646	10004	3/4" Brass Hose Nozzle for Y34/Y1/W34/X34/R34	
098547	55437	Nozzle for 70/71/B71/81	

Plunger

Part #	Mfg #	Description	Price
011663	10105	Plunger for Y30/Y34/Y70/Y95/W34	
011664	10106	Plunger for Y1/Y2	

Thermaline® Repair Parts

Thermaline® Parts

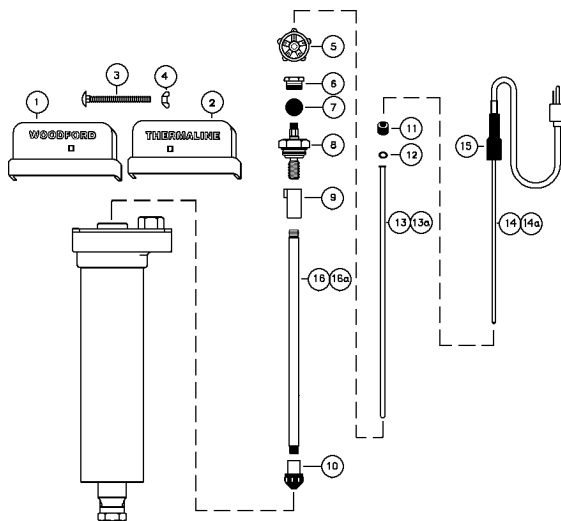

Part #	Mfg #	Description	Price
011747	85015	10 - Combination Valve Ass'y	

Thermaline® Repair Parts (Continued)

Thermaline® Parts

Part #	Mfg #	Description	Price
011748	85062	14 - 2' Heater Assembly (Includes Item 15)	

Repair Kits

Repair Kit for 14/18 Wall Faucet

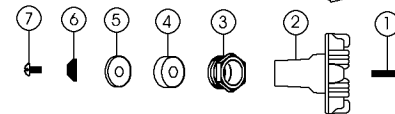
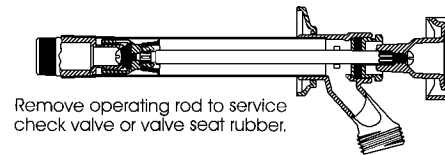

Part #	Mfg #	Description	Price
034143	RK14-MH	Repair Kit for 14/18 Includes 1-7, Metal Hdl	

Repair Kit for 17 Wall Faucet

- | | | | |
|----------|--------------|-----------|-------------------|
| 1. 35301 | VB Float Kit | 6. 30421 | Packing Washer |
| 2. 30002 | Handle Screw | 7. 30418 | Check Valve |
| 3. 30099 | Handle | 8. 30008 | Valve Seat Rubber |
| 4. 30059 | Packing Nut | 9. 30009 | Retainer Screw |
| 5. 30005 | Packing | 10. 30459 | Bevel Check Valve |

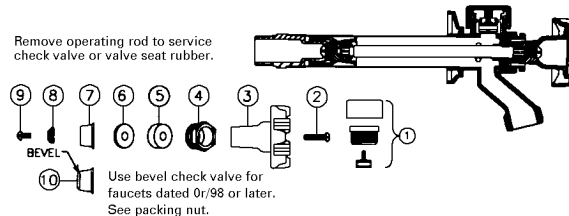

Part #	Mfg #	Description	Price
039455	RK-17	Repair Kit for 17 Includes 1-2, 4-10, 30099 Metal Hdl	

Woodford Repair Parts

Repair Kit for 22 Wall Faucet

1. 30566 Hot Plug Button
2. 30002 Handle Screw (2)
3. 30096 Round, Die Cast Alum. Wheel Handle (2)
4. 30497 Deep Packing Nut
5. 30560 EPDM Packing (2)
6. 30006 Packing Washer (2)
7. 30565 Cold Plug Button
8. 30059 Packing Nut
9. 30459 Check Valve (2)
10. 30008 Valve Seat Rubber (2)
11. 30009 Retainer Screw (2)

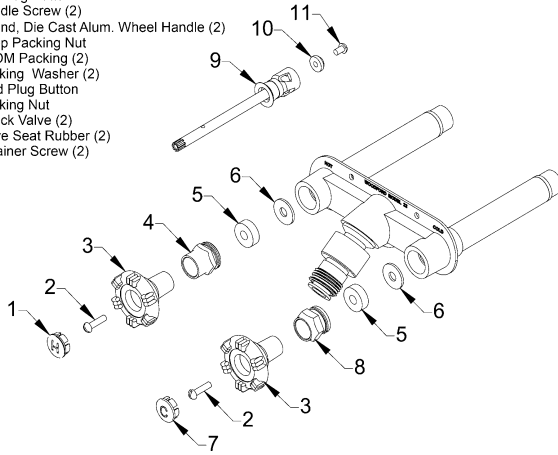

Part #	Mfg #	Description	Price
100876	RK-22MH	Repair Kit for 22 w/Metal Handle	

Repair Kit for 25/27H Wall Faucet

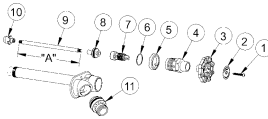

Part #	Mfg #	Description	Price
032340	RK-25	Wheel Handle Repair 5/16" Square Shank	

Repair Kit for 65 Wall Hydrant

1. 50009 Tee Key
2. 50264 Head Nut
3. 50252 Stem Washer
4. 55062 Stem Screw
5. 50251 "C" Washer
6. 51014 Yoke Nut
7. 50250 Plunger

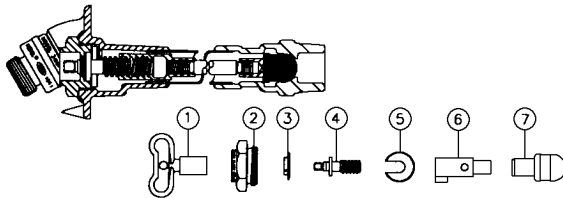

Part #	Mfg #	Description	Price
043118	RK-65	Chrome Repair Kit for 60/65/67 Includes 1-7	

Repair Kit for 70 Wall Hydrant

1. 50009 Tee key
2. 30109 Packing Nut
3. 30247 Packing
4. 55177 Head Nut Assy.
5. 51014 Yoke Nut
6. 50027 Support Washer
7. 51013 Ball Valve Rubber
8. 50028 Round Brass Nut

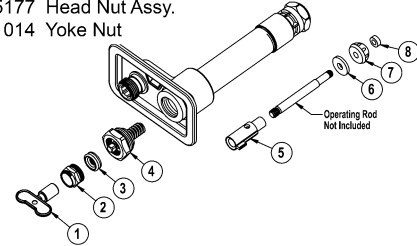

Part #	Mfg #	Description	Price
055079	RK-70	Repair Kit for 70 & Obsolete Models 7/8/80/85/90/95	

Repair Kit for Y34 Yard Hydrant

1. 10104 Rod Stem
2. 10100 Packing Nut
3. 10101 Packing
4. 10102 Support Washer
5. 10105 Plunger

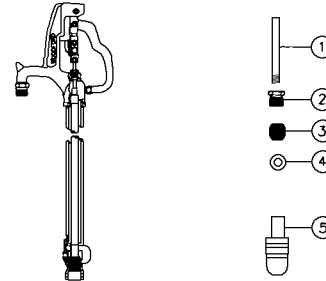

Part #	Mfg #	Description	Price
046472	RK-Y34	Includes 1-5	

Individual Parts



WF-MS

Part #	Mfg #	Description	Price
025782	30008	Rubber Valve Seat	
025786	30109	Chrome Packing Nut	
011710	30230	Plunger Assembly for 25	
011712	30238	Stem Screw Delrin for 25	
011716	35280	Drain Valve Assembly for 20/25/27	
011723	50250	Plunger for All Auto Drain Hydrants	
019019	50251	"C" Washer All Auto Drain Hydrants	
024447	50252	Stem Washer for All Auto Drain Hydrants	
011726	51014	Yoke Nut for All Freezeless Wall Hydrants	

Repair Parts

Woodford Repair Parts

Individual Parts (Continued)

Part #	Mfg #	Description	Price
011725	51013	Ball Valve Rubber	
112487	RH-MS	Roof Hydrant Mounting System	
116915	WF-MS	Mounting Sleeve for Models: 14, 16, 17 & 19	

Handle



30096

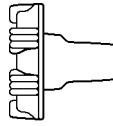

30099

Part #	Mfg #	Description	Price
054339	30096	14/17 Metal Wheel Handle	
011708	30099	14/17/22 Metal Wheel Handle	
095886	30106	24 Unplated Metal Handle	
011711	30233	24 Brown Lexan Wheel Handle	
022301	30239	25 2" Metal Wheel Handle	

Operating Rod Assembly

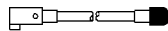

Part #	Mfg #	Description	Price
019023	55412	12" Operating Rod Assembly for Auto Drain (14-5/16" OAL)	

Packing



Part #	Mfg #	Description	Price
072390	30512	Packing Nut with Stem Gd for 14/17	
080502	30560	EPDM Packing for 14/17/22	

Rod Assembly

Part #	Mfg #	Description	Price
043133	35722	8" Wall Rod Assembly for 14/ 17/22/V22	
043888	WH35724	12" Wall Rod Assembly for 14/17/22/V22	

Tee Key



RK-STK

Part #	Mfg #	Description	Price
011719	RK-STK	Tee Key, 1-3/4" Short for 5/16" Square Stem (50009)	
011720	RK-LTK	3-1/4" Long Tee Key for Square Stem (50010)	

Repair Parts

Zoeller Repair Parts

Parts & Accessories

Gasket



Part #	Mfg #	Description	Price
052983	267007	Gasket - Case/Cover	

Switch Assembly



Part #	Mfg #	Description	Price
028971	004705	M53/98/72 Switch Assembly "50"	
052675	004892	ASM Rack Pk "50/90"AH	

Repair Parts

Drill Bits

Bi-Metal Utility Bits

- Extreme durability; long life even in nail-embedded wood
- Optimized for cordless drilling extending battery life
- (3) Cutting edges enhance chip removal for a fast, clean hole
- 6" Length
- Resharpenable with Lenox® Diamond file No. 25312



Part #	Mfg #	Size	Shank	Price
108511	10947	5/8"	1/4"	
108512	10948	3/4"	1/2"	
108513	10949	7/8"	1/2"	
108514	10950	1"	1/2"	
108515	10951	1-1/8"	1/2"	
108516	10952	1-1/4"	1/2"	
108517	10953	1-3/8"	1/2"	

3-Piece Bi-metal Utility Bit Set

Part #	Mfg #	Description	Price
108518	10954	Includes 3/4", 7/8" & 1"	

5-Piece Bi-metal Utility Bit Set



Part #	Mfg #	Description	Price
108519	10955	Includes 3/4", 7/8", 1", 1-1/8" & 1-1/4"	

Vari-Bits®

Vari-Bit® Step Drill Bit

- High speed steel construction and steam oxide coating
- (2) Cutting flutes for clean burr-free holes



Part #	Mfg #	Number Hole Size	Hole Size	Elec Drill Size	Price
027647	30881-VB1	13	1/8 - 1/2"	1/4"	
025886	30882-VB2	9	1/2 - 1"	3/8"	

Vari-Bits® (Continued)

Vari-Bit® Step Drill Bit

Part #	Mfg #	Number Hole Size	Hole Size	Elec Drill Size	Price
006268	30883-VB3	9	1/4 - 3/4"	3/8"	
053938	30912-VB12	5	7/8 - 1-3/8"	3/8"	

Vari-Bit® Kit



Part #	Mfg #	Description	Price
025885	30927-VBKA6	6-Piece Vari-Bit Kit	

Wood Bits

Lenox® Leader® Automatic Feed Wood Bit

- Forged body design, strong construction
- Can be re-sharpened with file

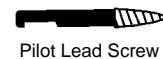

Pilot Lead Screw

Part #	Mfg #	Description	Price
037759	33901-34LS	#34 Leader Lead Screw Fits LL300-462	

Wood Boring Bit

- (2) Cutting edges, self-feeding, easy to resharpen
- Solid one-piece construction with black oxide rust inhibitor



Wood Boring Bit

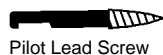

Pilot Lead Screw

Part #	Mfg #	Diameter	Price
006274	32150-WB150	1-1/2"	
006275	32175-WB175	1-3/4"	
006276	32200-WB200	2"	
006321	32900-WBPS	Pilot Lead Screws (Fits all sizes) 5/Pk	

Tools

Drill Bits

Bi-Metal Self-Feed Wood Drill Bit

- High speed steel cutting edit
- Chamfered edge, flutes remove excess wood chips
- Lead screw tip
- Shank cuts 4" x 4" without extension
- Quick change



Part #	Mfg #	Diameter	Price
028007	1787511	1"	
025197	1787512	1-1/8"	
025883	1787513	1-1/4"	
028008	1787515	1-3/8"	
006262	1787561	1-1/2"	
028009	1787562	1-3/4"	
006263	1787563	2"	
006264	1787564	2-1/8"	
028010	1787565	2-1/4"	
006265	1787566	2-9/16"	
025884	1787502	3"	

Bi-Metal Self-Feed Wood Drill Bit Accessories

Part #	Mfg #	Description	Price
022383	1787602	1" - 1-3/8" Lead Screws, 5/Pk	

Tools

Drill Bits

Drill Bits

Polished Double Enders Drill Bit

- Punch style length
- Bit at each end
- 135° Split point
- For use on sheet metal



Part #	Mfg #	Bit Dia	O/A Length	Price
006385	DE1/8	1/8"	2"	
006384	DE1/4	1/4"	2-1/2"	

Drill Bits

Shockwave® Driver Bit Sets

Shockwave™ 12PC Impact Drive Guide Set

- **OPTIMIZED SHOCKZONE™** absorbs peak torque and prevents breaking
- **CUSTOM ALLOY76™ STEEL** maximizes resistance to wear and shock
- Expandable sleeve for fast, straight driving
- Functional storage case can be used to gauge, strip, and bend wire, as well as fasten screws
- Includes:
 - (1) ECX™ Bit 1" #1
 - (1) ECX™ Bit 1" #2
 - (2) Phillips Bit 1" P2
 - (1) Phillips Bit 1" P3
 - (1) Slotted Bit 1" SL 1/4"
 - (1) Slotted Bit 1" SL 3/16"
 - (1) Square Bit 1" SQ2
 - (1) TORX® Bit 1" T15
 - (1) TORX® Bit 1" T20
 - (1) TORX® Bit 1" T25
 - (1) SHOCKWAVE™ 3 Magnetic bit tip holder



18PC Shockwave™ Driver Bit Set

- Geometric design provides the shock absorption
- Proprietary steel and heat treated process for maximum strength and durability
- Forged tips for maximum grip
- Includes:
 - (1) Phillips bit 1" P1
 - (1) Phillips bit 1" P2
 - (1) Phillips bit 1" P3
 - (1) Slotted bit 1" SL 1/4"
 - (1) Slotted bit 1" SL 3/16"
 - (1) Square bit 1" SQ1
 - (1) Square bit 1" SQ2
 - (2) Phillips bit 2" P2
 - (1) Phillips bit 2" P3
 - (2) Square bit 2" SQ2
 - (1) Square bit 2" SQ3
 - (1) TORX® 2" T15
 - (1) TORX® bit 2" T20
 - (1) 3 1/2" Phillips #2
 - (1) 3 1/2" Square drive #2
 - (1) Case with bulk storage container
 - (1) SHOCKWAVE™ magnetic bit holder



Part #	Mfg #	Description	Price
164158	48-32-4507	Shockwave™ 12PC Impact Drive Guide Set	

Part #	Mfg #	Description	Price
161626	48-32-4403	18PC Shockwave Driver Bit Set	

Drill Bits

26-Piece Shockwave™ Drive and Fasten Set

- Forged tips for maximum grip
- Proprietary steel and heat treat process for maximum strength and durability
- Includes:
 - Phillips bits:
 - 1"-(1) P1, (1) P2, (3) P3
 - 2"-(1) P2
 - Square bits:
 - 1"-(1) SQ1, (2) SQ2, (1) SQ3
 - 2"-(1) SQ2
 - Torx® bits:
 - 1"-(2) T20, (2) T25, (1) T30
 - 2"-(1) T20, (1) T25
 - 1/4" Hex to 3/8" square adapter (1)
 - 1/4" Magnetic nut driver (1)
 - Slotted bit 1" SL 3/16" (1)
 - Drive Sockets:
 - (1)3/8" Drive: 1/2" Socket,
 - (1)3/8" Drive: 9/16" Socket
 - Magnetic nut drivers:
 - (1)3/8" Magnetic nut driver,
 - (1)5/16" Magnetic nut driver
 - (1) Shockwave™ compact magnetic bit holder



Part #	Mfg #	Description	Price
173708	48-32-4408	26-Pc Shockwave Drive and Fasten Set	

29-Piece Shockwave® Impact Duty™ Driver Bit Set

- Diameter: 1/4"
- Forged tip
- Includes:
 - Phillips bits:
 - 1" - (1) P1, (7) P2, (2) P3;
 - 2" Power - (2) P2, (1) P3
 - Square bits:
 - 1" - (1) SQ1, (4) SQ2, (1) SQ3
 - 2" Power - (2) SQ2
 - Torx® bits:
 - 1" - (1) T15, (1) T20, (1) T25
 - Magnetic nut drivers: (1) 1/4" red, (1) 5/16" amber, (1) 3/8" blue
 - (1) Magnetic bit holder
 - (1) Case with bulk storage container



Part #	Mfg #	Description	Price
137578	48-32-4401	29-Pc Shockwave Driver Bit Set	

32-Piece Shockwave™ Driver Bit Set

- Forged tips for maximum grip
- Geometric design provides the shock absorption
- Includes:
 - Magnetic nut driver:
 - (1) 1/4", (1) 5/16"
 - Phillips bits:
 - 1" (1) P1, (4) P2, (1) P3
 - 2" (2) P2
 - Phillips reduced 1" PR2 bit
 - Slotted:
 - 1" (1) #8, (1) #10
 - 2" (1) #10
 - Square bits:
 - 1" (1) SQ1, (3) SQ2, (1) SQ3
 - 2" (1) SQ2
 - Torx® bits:
 - 1" (1) T15, (2) T20, (2) T25, (1) T30
 - 2" (1) T20, (1) T25



Part #	Mfg #	Description	Price
173709	48-32-4004	32-Pc Shockwave Driver Bit Set	

35-Piece Shockwave® Impact Duty™ Driver Bit Set

- Forged tip
- Includes:
 - ECX™: 1" - (1) ECX1, (1) ECX2
 - Phillips bits:
 - 1" (1) Ps, (2) P2, (1) P3;
 - 2" Power: (1) P1, (1) P2
 - 3-1/2" Power: (1) P2
 - Square bits:
 - 1" (1) SQ1, (2) SQ2, (1) SQ3
 - 2" Power: (1) SQ1, (1) SQ2, (1) SQ3
 - 3-1/2" Power: (1) SQ2
 - Torx® bits:
 - 2" Power: (1) T15, (1) T20, (1) T25, (1) T30
 - Slotted bits:
 - 2" Power: (1) SL 1/8", (1) SL 3/16", (1) SL 1/4"
 - Magnetic nut drivers: (1) 1/4" red, (1) 5/16" amber, (1) 3/8" blue
 - Hex Shank Drill Bits:
 - 1/4" (1) 1/8", (1) 5/32", (1) 3/16", (1) 7/32", (1) 1/4"
 - Socket adapters: (1) 1/4" hex shank to 3/8" square
 - (1) 1/4" hex shank to 1/2" square
 - (1) Magnetic bit holder
 - (1) Case with bulk storage container



Part #	Mfg #	Description	Price
140584	48-32-4402	M/E Drill & Drive Set 35-Pc	

Tools

Drill Bits

36-Piece Shockwave™ Driver Bit Set

- Geometric design provides the shock absorption
- Forged tips for maximum grip
- Includes:
 - (1) 1/4" Insert magnetic nut driver
 - (1) 3/8" Socket adapter
 - (1) 5/16" Insert magnetic nut driver
 - (1) Shockwave™ 6" Magnetic bit tip holder
 - (1) Shockwave™ Compact magnetic bit holder
 - Hex bits:
 - 1" (1) 1/4", (1) 1/8", (1) 3/16", (1) 3/32", (1) 5/32", (1) 5/64", (1) 7/64", (1) 9/64"
 - Phillips bits:
 - 1" (1) P1, (3) P2, (1) P3
 - (1) Phillips reduced 1" PR2 bit
 - Slotted bits:
 - 1" (2) #10, (1) #12, (1) #8
 - Square bits:
 - 1" (1) SQ1, (1) SQ3
 - Torx® bits:
 - 1" (1) T10, (1) T15, (2) T20, (2) T25, (1) T27, (1) T30, (1) T40



Part #	Mfg #	Description	Price
173710	48-32-4005	36-Pc Shockwave Driver Bit Set	

40PC Shockwave™ Drill & Drive Set

- Geometric design provides the shock absorption
- Forged tips for maximum grip
- Includes:
 - (1) 1/2" Socket adapter
 - (1) 1/4" Magnetic nut driver
 - (1) 1/4" Shockwave Hex drive bit
 - (1) 1/8" Drill bit
 - (1) 3/16" Shockwave Hex drive bit
 - (1) 3/8" Magnetic nut driver
 - (1) 3/8" Socket adapter
 - (1) 5/16" Magnetic nut driver
 - (1) Shockwave™ Compact magnetic bit holder
 - Hex bits:
 - 1" (1) 1/4", (1) 1/8", (1) 3/16", (1) 5/32"
 - Phillips bits:
 - 1" (1) P1, (2) P2, (1) P3
 - 2" (4) P2, (1) P3
 - (1) Phillips reduced 1" PR2 bit
 - Slotted bits:
 - 1" (1) #10, (1) #8
 - 2" (1) #10
 - Square bits:
 - 1" (1) SQ1, (2) SQ2, (1) SQ3
 - 2" (1) SQ2, (1) SQ3
 - TORX® BITS:
 - 1" (1) T15, (1) T20, (2) T25
 - 2" (1) T20, (2) T25



Part #	Mfg #	Description	Price
173711	48-32-4006	40-Pc Shockwave Driver Bit Set	

SHOCKWAVE™ Impact Hex Drill Bit

- Extreme durability: Thicker web provides greater strength and longer life
- Fast, accurate drilling: 135° split point tip starts on contact to prevent walking, while the parabolic flute clears chips fast
- Corrosion resistant: Black Oxide coating provides lubricity and resists corrosion of the bit
- Reduced down time: 1/4" Hex power groove shank offers quick bit changes



Part #	Mfg #	Description	Price
164178	48-89-4401	1/16" SHOCKWAVE™ Impact Hex Drill Bit	
164187	48-89-4403	3/32" SHOCKWAVE™ Impact Hex Drill Bit	
164179	48-89-4405	1/8" SHOCKWAVE™ Impact Hex Drill Bit	
164188	48-89-4406	9/64" SHOCKWAVE™ Impact Hex Drill Bit	

Drill Bits

Shockwave® Driver Bit Sets (Continued)

SHOCKWAVE™ Impact Hex Drill Bit

Part #	Mfg #	Description	Price
164180	48-89-4407	5/32" SHOCKWAVE™ Impact Hex Drill Bit	
164181	48-89-4409	3/16" SHOCKWAVE™ Impact Hex Drill Bit	
164182	48-89-4411	7/32" SHOCKWAVE™ Impact Hex Drill Bit	
164183	48-89-4413	1/4" SHOCKWAVE™ Impact Hex Drill Bit	
164184	48-89-4414	5/16" SHOCKWAVE™ Impact Hex Drill Bit	
164185	48-89-4415	3/8" SHOCKWAVE™ Impact Hex Drill Bit	
164186	48-89-4417	1/2" SHOCKWAVE™ Impact Hex Drill Bit	

Thunderbolt® Bits

Thunderbolt® Drill Bit Set



Part #	Mfg #	Description	Price
137838	48-89-2803	15-Pc Black Oxide Bit Set	
154239	48-89-2801	21-Pc Black Oxide Bit Set	

Thunderbolt® Black Oxide Drill Bit

- Thunderbolt® web provides longer life and faster drill times 
- Parabolic flute clears chips faster
- 135° Split point, precision start no walking

Part #	Mfg #	Diameter	Price
137807	48-89-2710	1/16"	
137808	48-89-2711	5/64"	
137809	48-89-2712	3/32"	
137810	48-89-2713	7/64"	
137812	48-89-2714	1/8"	
137813	48-89-2715	9/64"	
137815	48-89-2716	5/32"	
137816	48-89-2717	11/64"	
137817	48-89-2718	3/16"	
137818	48-89-2719	13/64"	
137819	48-89-2720	7/32"	

Thunderbolt® Bits (Continued)

Thunderbolt® Black Oxide Drill Bit

Part #	Mfg #	Diameter	Price
137820	48-89-2721	15/64"	
137821	48-89-2722	1/4"	
137822	48-89-2723	17/64"	
137823	48-89-2724	9/32"	
137824	48-89-2725	19/64"	
137825	48-89-2726	5/16"	
137826	48-89-2727	21/64"	
137827	48-89-2728	11/32"	
137828	48-89-2729	23/64"	
137829	48-89-2730	3/8"	
137830	48-89-2731	25/64"	
137831	48-89-2732	13/32"	
137832	48-89-2733	27/64"	
137833	48-89-2734	7/16"	
137834	48-89-2735	29/64"	
137835	48-89-2736	15/32"	
137836	48-89-2737	31/64"	
137837	48-89-2738	1/2"	

Thunderbolt® Aircraft Length Black Oxide Drill Bit

- Thunderbolt® web provides longer life and faster drill times 
- Parabolic flute clears chips faster
- 135° Split point, precision start no walking

Part #	Mfg #	Diameter	Price
138278	48-89-2772	1/4" x 12"	

Flat Boring Bits & Accessories

Flat Boring Bit

- Fluted bit clears chips 
- Bores cleaner and faster
- Furnished with hole for use in wire pulling
- Flats for secure chuck grip
- Precision made of high carbon steel for durability and long life

Part #	Mfg #	Shank Dia	Overall Length	Price
006918	48-27-0371	3/8" x 6"	Flat Boring Bit	
170327	48-27-0621	5/8" x 6"	Flat Boring Bit	
170328	48-27-1121	1-1/8" x 6"	Flat Boring Bit	
170329	48-27-1251	1-1/4" x 6"	Flat Boring Bit	
170330	48-27-1371	1-3/8" x 6"	Flat Boring Bit	
170331	48-27-1501	1-1/2" x 6"	Flat Boring Bit	

Drill Bits

Flat Boring Bit Sets

8-Piece Universal Quik-Lok™ Flat Boring Bit Set

- Includes the Universal Quik-Lok™
- Double wing spurs
- 1/4" Quick change hex shank



Part #	Mfg #	Description	Price
137800	49-22-0175	8-Pc Flat Boring Bit Set with 6" Extension	

Flat Boring Bit Kit

- Contains (6) popular size flat boring bits in heavy protective plastic
- In pockets for orderly storage and easy size selection



Part #	Mfg #	Sizes Include:	Price
006980	49-22-0071	3/8", 1/2", 5/8", 3/4", 7/8" & 1"	

Speed Feed Wood Bit

- Efficient: up to 10x faster drilling than flat boring bits
- Fast chip removal: nonstick, polished and coated flutes eliminate costly cleaning time
- Clean holes: double wing spurs permit cleaner hole cutting
- Versatile: 1/4" power groove shank fits all 1/4" extensions



Part #	Mfg #	Description	Price
170321	48-13-0048	1/2" x 6" Speed Feed Wood Bit	
170322	48-13-0058	5/8" x 6" Speed Feed Wood Bit	
170323	48-13-0068	3/4" x 6" Speed Feed Wood Bit	
170324	48-13-0078	7/8" x 6" Speed Feed Wood Bit	
170325	48-13-0088	1" x 6" Speed Feed Wood Bit	
170326	48-13-0108	1-1/4" x 6" Speed Feed Wood Bit	

Bit Kits

Contractors' Bit Kit

- Assortment of self-feed bits for big hole drilling
- Includes impact resistant carrying case



Part #	Mfg #	Description	Price
006982	49-22-0135	1-3/8", 1-1/2", 2-1/8", 2-9/16"	

Plumbers' Bit Kit

- Complete assortment of the most commonly used Milwaukee® bits for big hole drilling
- Includes 5-1/2" 1-piece shank and coupling extension and carrying case
- Includes:
 - Self-feed bits: 1-3/4", 2-1/8" & 2-9/16"
 - Auger bits: 7/8", 1-1/8", 1-1/4" & 1-1/2"



Part #	Mfg #	Sizes Include:	Price
140832	49-22-0065	7/8", 1-1/8", 1-1/4", 1-1/2" Auger Bits & 1-3/4", 2-1/8" & 2-9/16" Dia Self-feed Bits	

Drill Accessories

Bellhanger Bit

- Aggressive tip geometry for faster drilling
- Coated flutes for fast chip removal
- Wire pulling hole
- 3-Flat shank



Part #	Mfg #	Dia	OAL	Price
138408	48-13-7125	1/4"	12"	
140014	48-13-7225	1/4"	18"	
138666	48-13-7325	1/4"	24"	
153612	48-13-7337	3/8"	24"	

Hole Saw Accessories

Rotary Hammer Bit

- SDS Shank



Part #	Mfg #	Size	Price
137647	48-20-7410	3/16" x 2" x 4"	
137648	48-20-7411	3/16" x 4" x 6"	
137649	48-20-7430	1/4" x 2" x 4"	
137650	48-20-7431	1/4" x 4" x 6"	
137651	48-20-7441	5/16" x 4" x 6"	
137652	48-20-7451	3/8" x 4" x 6"	

Drill Bits

Hole Saw Accessories (Continued)

Rotary Hammer Bit

Part #	Mfg #	Size	Price
137653	48-20-7471	1/2" x 4" x 6"	

Selffeed Bit

- *Faster, more accurate drilling: Center feed screw pilots the bit and allows the bit to pull through fast*
- *Clean holes: Inside cutting plane shaves the hole radius for clean, smooth holes without pressure*
- *Long-lasting performance: Bits are resharpenable and include two removable, replaceable feed screws*



Part #	Mfg #	Description	Price
169683	48-25-1502	Selffeed Bit 1-1/2"	
169684	48-25-2122	Selffeed Bit 2-1/8"	

For 1/2" D-Handle & Larger Model Drill



Part #	Mfg #	Dia	Shank Type	Price
006907	48-25-1371	1-3/8"	7/16" Hex	
006911	48-25-2121	2-1/8"	7/16" Hex	

For 1/2" D-Handle & Larger Model Drill Except 1001-1 & 1007-1

Part #	Mfg #	Dia	Shank Type	Price
006912	48-25-2561	2-9/16"	7/16" Hex	

Switchblade™ 5-Piece Plumbers' Kit

- *Aggressive feed screw design*
- *Blades made with hardened steel*
- *Size and model number engraved on each bit*
- *Includes:*
 - (4) Switchblade™ self-feed bit blades - 1-3/8", 1-1/2", 2-1/8" and 2-9/16"
 - (1) Universal Quik-Lok® extension - 5-1/2" x 7/16"
 - (1) Each replacement blades - 1-3/8", 1-1/2", 2-1/8", and 2-9/16"
 - (4) Feed screws
 - (4) Set screws
 - (1) Hex wrench
 - Removable storage case
 - Compact carrying case with handle



Part #	Mfg #	Description	Price
149390	49-22-5100	5-Pc Switchblade Plumbers Kit	

Replacement Feed Screw Kit

- *For Switchblade™ selffeed bits*
- *Up to 2-9/16"*
- *Faster, more accurate drilling*



Part #	Mfg #	Description	Price
150897	48255275	Replacement Feed Screw Kit	

Step Drill Bits

Step Drill Bit, Single Hole

- *JAM-FREE performance: Dual-flute design provides greater speed and control*
- *Up to 2X faster*
- *Rapid Strike™ Tip: creates fast, accurate starts and generates less heat*
- *Up to 4X longer bit life*
- *Up to 50% more holes per battery charge*
- *Laser-engraved reference marks*
- *3-Flat Secure-Grip™ shanks*



Part #	Mfg #	Description	Price
169382	48-89-9207	#7 Step Drill Bit, 7/8" Single Hole	

Drill Bits

High Speed Steel Step Drill Bit

- *Jam-Free performance: Dual flute design provides greater speed and control*
- *Up to 2X faster: Optimized for cordless drills in high speed*
- *Rapid Strike™ Tip: Creates fast, accurate starts and generates less heat*
- *Up to 4X longer bit life: Optimized geometry with Black Oxide coating to cut faster and produce less heat*
- *Up to 50% more holes per battery charge: Greater user productivity*
- *Laser-engraved reference marks: Easily stop on any hole size*
- *3-Flat Secure-Grip™ shanks: Reduces bit slippage in the chuck*



Part #	Mfg #	Size	# of Holes	Price
140835	48-89-8960	1/4" x 1-3/8" x 1/8"	10	
169191	48-89-9201	#1 Step Drill Bit, 1/8" - 1/2" by 1/32"		
169381	48-89-9202	#2 Step Drill Bit, 3/16" - 1/2" by 1/16"		
169186	48-89-9203	#3 Step Drill Bit, 1/4" - 3/4" by 1/16"		
169187	48-89-9204	#4 Step Drill Bit, 3/16" - 7/8" by 1/16"		
169188	48-89-9206	#6 Step Drill Bi, 3/8" & 1/2" by 1/16"		
169189	48-89-9208	#8 Step Drill Bit, 1/2" - 1" by 1/16"		
169190	48-89-9209	#9 Step Drill Bit, 7/8" & 1-1/8"		
169383	48-89-9211	#11 Step Drill Bit, 7/8" - 1-7/32"		
169384	48-89-9212	#12 Step Drill Bit, 7/8" - 1-3/8"		

2-Piece Step Drill Bit Set

- *Includes:*
 - (1) 13-Hole bit (48-89-9100)
 - (1) 9-Hole bit (48-89-9105)



Part #	Mfg #	Description	Price
145131	48-89-9050	2-Pc Step Drill Bit Set	

3-Piece Step Drill Bit Set

- *Includes:*
 - (1) 6-Hole bit (48-89-8955)
 - (1) 9-Hole bit (48-89-9105)
 - (1) 13-Hole bit (48-89-9100)



Part #	Mfg #	Description	Price
145130	48-89-8990	3-Pc Step Drill Bit Set	

SDS Bits and Accessories

SDS-Max Bit

- *SDS-Max shank*
- *4-Cutter head*
- *Highest quality carbide maximizes material pulverization*
- *Optimized flutes provide fastest debris extraction for faster drilling*



Part #	Mfg #	Description	Price
154017	48-20-3918	SDS-Max Bit 5/8" x 21"	

SDS-Plus 2CT Bit

- *Enhanced rebar guards provide increased durability*
- *Breaker points lead to faster drilling speeds*
- *Variable flute for 20% more holes per charge*
- *Centering tip for exact spot drilling*
- *Wear mark indicators to show end of life and when bit no longer meets ANSI requirement*
- *Reinforced flutes for minimized vibration and maximum durability*



Part #	Mfg #	Description	Price
170315	48-20-7432	SDS-Plus 2CT 1/4" x 6" x 8"	
170316	48-20-7452	SDS-Plus 2CT 3/8" x 6" x 8"	
167611	48-20-7459	SDS-Plus 2CT 3/8" x 22" x 24"	
170317	48-20-7474	SDS-Plus 2CT 1/2" x 10" x 12"	
170318	48-20-7481	SDS-Plus 2CT 9/16" x 4" x 6"	
170319	48-20-7601	SDS-Plus 2CT 5/8" x 4" x 6"	
170320	48-20-7604	SDS-Plus 2CT 5/8" x 10" x 12"	
170314	48-20-7065	SDS-Plus 2CT 3/4" x 10" x 12"	

Drill Bits

SDS-Plus 4CT MX4™ Bit

- Enhanced rebar guards provide increased durability
- Breaker points lead to faster drilling speeds
- Variable flute for up to 20% more holes per charge in rotary hammers
- Centering tip for exact spot drilling
- Wear mark indicators to show end of life and when bit no longer meets the ANSI requirement
- Reinforced flutes for minimized vibration and maximum durability



Part #	Mfg #	Description	Price
152697	48-20-7206	SDS-Plus 4CT MX4™ 5/8" x 16" x 18"	

SDS Bit Assortment

- Includes:
 - 3/16" x 4-1/2"
 - 1/4" x 6"
 - 5/16" x 6"
 - 3/8" x 6"
 - 1/2" x 6"
- SDS Shank
- Carbide



Part #	Mfg #	Description	Price
137655	48-20-7490	5-Pc SDS Bit Set	

SDS Bit - 44 Magnum™ Series

- 4-Fluted spiral shaft



Part #	Mfg #	Bit Dia	Overall Length	Drilling Depth	Price
137646	48-20-7401	5/32"	4"	6"	
137657	48-20-7602	5/8"	6"	8"	

SDS Bit with 1/4" Hex

- 2-Cutter head
- SDS Shank with hex shoulder for Tap-Con screw system



Part #	Mfg #	Bit Dia	Overall Length	Drilling Depth	Price
137644	48-20-7091	5/32"	7"	4"	
137645	48-20-7092	3/16"	7"	4"	

Stop Bit SDS-PLUS

- For use with drop-in anchors
- Stopping shoulder to drill accurate depths repeatedly
- Patented flute geometry to remove debris rapidly and maximize impact energy
- Centering tip to reduce bit walking and create exact spot drilling



Part #	Mfg #	Description	Price
171096	48-20-7651	3/8" x 1-1/16" Stop Bit SDS-PLUS	
171101	48-20-7653	1/2" x 1-11/16" Stop Bit SDS-PLUS	
171103	48-20-7655	5/8" x 2-1/16" Stop Bit SDS-PLUS	

Hammer Drill Bits

Carbide-Tip Hammer Drill Bit

Part #	Mfg #	Description	Price
137662	48-20-8810	1/4" x 2" x 4" with Hex Shank	

Three-Flat Secure-Grip™ Hammer Drill Bit

- Fast drilling, long life
- 3-Flat Secure-Grip™ prevents bit from slipping in the chuck



Part #	Mfg #	Size	Price
137665	48-20-8821	3/8" x 4" x 6"	
137658	48-20-8800	1/8" x 1-1/2" x 3"	
137663	48-20-8811	1/4" x 4" x 6"	
137659	48-20-8801	5/32" x 4" x 6"	
137660	48-20-8805	3/16" x 2" x 4"	
137661	48-20-8806	3/16" x 4" x 6"	
137664	48-20-8816	5/16" x 4" x 6"	
137666	48-20-8830	1/2" x 4" x 6"	

5-Piece, 3-Flat Secure-Grip™ Hammer-Drill Bit Set

- Comprehensive offering with diameters from 1/8" to 1" with lengths up to 18"



Part #	Mfg #	Description	Price
137667	48-20-8851	Bit Hammer-Drill Kit	

Drill Bits

Scraping Chisel

- Scraping chisel
- 3/4 inch Hex with 21/32 inch round shank
- 2 inch width x 12 inch overall length
- Made from forged high grade steel



Part #	Mfg #	Description	Price
172488	48-62-2065	2" Scraping Chisel	

SDSMAX DEMO FLAT CHISEL

- Cold chisel
- SDS-Max shank
- Made from forged high grade steel



Part #	Mfg #	Description	Price
167377	48-62-4079	SDSMAX Demo 12" Flat Chisel	

SHOCKWAVE™ 1/2" Deep Well Socket Set (9 PC)

- Chromoly steel and custom heat treatment for maximum durability in high torque applications
- Radius corners: drives on flats to reduce stripping and breakage
- Thin wall construction for impact strength in tight clearance applications
- Includes:
 - (1) 3/8" SHOCKWAVE impact socket
 - (1) 7/16" SHOCKWAVE impact socket
 - (1) 1/2" SHOCKWAVE impact socket
 - (1) 9/16" SHOCKWAVE impact socket
 - (1) 5/8" SHOCKWAVE impact socket
 - (1) 11/16" SHOCKWAVE impact socket
 - (1) 3/4" SHOCKWAVE impact socket
 - (1) 7/8" SHOCKWAVE impact socket
 - (1) 1/4" Hex to 1/2" square adapter



Part #	Mfg #	Description	Price
160302	49-66-4484	SHOCKWAVE™ 1/2" Deep Well Socket Set (9 PC)	

Tools

Drill Bits

Drill Bits

Straight Shank Drill Bit

- Jobbers length for high speed
- For wood or metal
- General purpose



Part #	Mfg #	Size	Price
052311	4714	1/2"	

Drill Bits

Compact Benders

Compact Bender Kit

- *Body and crossbar for:
1/4" to 7/8", 1/4", 5/16",
3/8", 1/2", 5/8", 3/4", and
7/8" mandrels*
- *One-handed operation*



1839032

Part #	Mfg #	Description	Price
165774	1839032	CBK Compact Bend	
176360	1926598	CBK Compact Bend, With Reverse Bend Attachment	

Flaring Tools

Flaring Tools

Pro-Set® Flaring Tool



- For use on the following tube materials:
 - Copper
 - Aluminum
 - Brass
 - Thin-Wall Steel

Part #	Mfg #	Description	Price
134798	87-FT800FN	R-410A Imperial Block 3/16", 1/4", 5/16", 3/8", 1/2", 5/8", 3/4" with Ratchet	

Flaring Tools

Flaring Tools

Ratchet Flaring Tool

- Ratcheting feed screw handle
- Hardened steel flaring cone, eccentrically mounted in needle bearings



Part #	Mfg #	Model	Type	Sizes	Price
045766	83037	458R	45° SAE Flares	1/8", 3/16", 1/4", 5/16", 3/8", 1/2", 5/8", 3/4"	

Flaring Tool

- Precision designed tool for producing 45° flares in soft copper, brass, aluminum, and mild steel (JIC and Bundy) tubing
- A hardened, smooth cone provides fast, 45° flares either single or double lap
- A single clamp screw provides for easy clamping and removal of tubing



Part #	Mfg #	Model	Type	Sizes	Price
008721	23332	345	45° SAE Flares	3/16", 1/4", 5/16", 3/8", 7/16", 1/2", 5/8"	

Hammer-Type Flaring Tool

- Made of high-grade hardened steel
- Long nose guide that centers tools for smooth, 45° uniform flares



Part #	Mfg #	Model	Water Tube Size	Price
067998	41320	E-45	1/2"	
008618	41330	E-47	3/4"	
008625	41335	E-52	1"	
025807	41345	E-63	1-1/2"	
022441	41350	E-64	2"	

Tools

Flaring Tools

Flaring Tools

Flaring Tool

- *Makes smooth flare*
- *For OD sizes 3/16", 1/4", 5/16", 3/8", 1/2" and 5/8"*



Part #	Mfg #	Description	Price
041946	J40-080	Bar Flaring Tool	

Copper Swedge Tools

- *Heat-treated carbon steel*
- *Can be used on copper tube, oft copper, aluminum or any other thin-walled tubing*



Part #	Mfg #	Description	Price
064624	J40-369	5/8" to 1-1/8" Copper Swedge	

Flashlights

M12™ Lithium-Ion Cordless Work Lights

M12™ Work Light

- REDLITHIUM™ battery technology
- Compact design
- 90° rotating head
- Integrated magnet



Part #	Mfg #	Description	Price
164019	49-24-0145	M12™ Work Light	

M12™ TRUEVIEW™ LED Spotlight

- Up to 700 yard beam distance
- 3 Light output modes for distance, clarity, and safety
- High: 750 lumens
- Low: 400 lumens
- Strobe: 800 lumens
- Impact and moisture resistant



Part #	Mfg #	Description	Price
181689	2353-20	M12™ LED Spotlight	

M18™ ROCKET™ LED Tower Light

- 7ft Max extension
- Rotating and pivoting head is extendable from 4-7ft
- Compact 26" footprint w/ low center of gravity
- Three light output modes
 - High: 2,000 lumens
 - Medium: 1,300 lumens
 - Low: 850 lumens
- Impact resistant, reinforced legs



Part #	Mfg #	Description	Price
137576	49-24-0146	90° Pivoting Head	
181687	2130-20	18V, High Definition Output	

M18 Rocket™ LED Tower Light/Charger

- 5 Second setup, 7 foot extension
- 3,000 Lumens of multidirectional light
- Impact resistant, reinforced legs
- Built in M18™ charger
- Covered AC Plug-in
- 3 Independently pivoting light heads
- Protective guard to secure head and lens during transport and storage
- Compact footprint, low center of gravity
- Low battery indicator



Part #	Mfg #	Description	Price
226119	2135-20	M18 ROCKET™ LED Tower Light/Charger (Tool Only)	
226121	2135-21HD	M18 ROCKET™ LED Tower Light/Charger Kit	

M12™ LED Lantern/Flood Light

- TRUEVIEW™: High definition lighting technology
- 180° - 360° Adjustable beam
- 2.1A USB Charger
- Rugged design
- Four light settings: High, medium, low, strobe
- Two stainless steel hooks



Part #	Mfg #	Description	Price
171826	2362-20	M12™ LED Lantern/Flood Light	

M18™ Lithium-Ion Cordless Work Lights

M18™ Cordless Work Light

- Uses 18V compact or XC high capacity Lithium-Ion battery (sold separately)
- Xenon incandescent bulb
- Fold away utility hook



Part #	Mfg #	Description	Price
148143	49-24-0171	135° Rotating Head	

Flashlights

M18™ Cordless LED Work Light

- Sealed, aluminum head
- 160 Lumen LED
- Lasts up to 12 hours on one charge
- Integrated hook



Part #	Mfg #	Description	Price
137577	2735-20	135° Rotating Head	

M12™ LED Stick Light (Bare Tool)

- TRUEVIEW™ High definition lighting technology
- Powerful 3-LED design
- Multi-position stainless steel hook
- Over 4+ hours of run-time
- Bright, smooth, even beam pattern
- Impact resistant/replaceable lens



Part #	Mfg #	Description	Price
158985	2351-20	M12™ LED Stick Light (Bare Tool)	
158986	49-24-2351	M12™ LED Stick Light Accessory Magnet	

M18™ LED Flood Light

- Trueview: High definition lighting technology
- Up to 30% brighter than corded 250 halogen lights
- Up to 8 hours of run-time
- Limited lifetime LED warranty
- Innovative roll cage design
- Multiple hanging features: emt hanger, key hole hanger, cross bar hanger, handle hanger



Part #	Mfg #	Description	Price
161982	2361-20	M18™ LED Flood Light	

M18™ Rover™ LED Dual Power Flood Light

- Three light output modes
- Medium Mode: 1,500 lumens for up to 4 hours with M18™ XC 5.0 Pack
- High Mode: 3,000 lumens for up to 2 hours with M18™ XC 5.0 Pack
- Low Mode: 650 lumens for up to 8 hours with M18™ XC 5.0 Pack
- High Definition Output with true color, even beam, and natural light
- Dual Power Source: M18™ or Corded
- Light Head rotates 240° with positive stops
- (3) integrated keyholes for hanging horizontally or vertically
- Durable Roll Cage protects light head



Part #	Mfg #	Description	Price
181688	2360-20	M18™ LED Dual Power Flood Light	

M18™ LED Stick Light

- TRUEVIEW: High definition lighting technology
- Forward and backward pivoting head
- Rugged design: replaceable lens plate and chemical resistant body
- Two adjustable metal hooks
- Compact design



Part #	Mfg #	Description	Price
172034	2352-20	M18™ LED Stick Light	

M18™ LED Lantern/Flood Light

- TRUEVIEW: High definition lighting technology
- 180° - 360° Adjustable beam
- 2.1A USB Charger
- Rugged design
- Four light settings: High, medium, low, strobe
- Two stainless steel hooks



Part #	Mfg #	Description	Price
171827	2363-20	M18™ LED Lantern/Flood Light	

Flashlights

M18 RADIUS™ LED Compact Site Light w/ ONE-KEY™

- Set light remotely from 50ft
- Optimize brightness and runtime
- Program automatic schedule
- Lighting for task, area, and overhead
- 4,400 Lumens for maximum coverage
- High impact polycarbonate lens
- AC in and out: string up to 10 together
- Protected AC plugs self-centering hang hook
- Reinforced hang hole
- 180 and 360 electronic: light control
- Low battery indicator



Part #	Mfg #	Description	Price
222799	2146-20	M18 RADIUS™ LED Compact Site Light w/ ONE-KEY™	

Replacement Bulbs



49-81-0030



49-81-0090

Part #	Mfg #	Description	Price
141993	49-81-0030	Bulbs for 18V Work Light, 2/Pk	
138845	49-81-0090	LED Upgrade for M12™, M18™, V28® Work Lights	

Flashlights

LED Flashlights

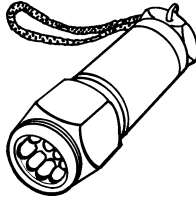

Part #	Mfg #	Description	Price
136007	R319350	Pocket LED Lightstick	

Flashlights

Rayovac Industrial Flashlights

- Yellow flashlight with ring hangers

RAYOVAC



Part #	Mfg #	Description	Price
052370	F20-001	(2) D Cell	

Batteries

Rayovac Heavy-Duty Alkaline Batteries

RAYOVAC



F20008



F20010



F20009



F20011



F20012

Part #	Mfg #	Description	Price
045080	F20-008	(8) AA Alkaline	
052368	F20-009	(6) 9 Volt Alkaline	
052369	F20-010	(6) C Alkaline	
045082	F20-011	(6) D Alkaline	
045081	F20-012	(8) AAA Alkaline	

Flashlights

Flashlights

LED Mini Pocket Flashlight

- 5mm Nichia white LED light
- 50,000 Hours of lamp life
- 9-Lumen tested light-output generates a strong concentrated beam
- Battery life: 130 hours
- Pushbutton on/off switch provides constant or momentary modes
- Polycarbonate body with o-ring sealed Xenoy® shroud
- Includes a breakaway lanyard and pocket clip
- Interchangeable clear, red and green colored discs



Part #	Mfg #	Description	Price
120393	X5	(4) LR44 Batteries	



Sensible Products



Sensible Products

Flashlights

Flashlights

Extendable Magnetic Flashlight

- Magnet on grip and at light
- Telescopes from 6.5" to 21"
- Flexible shaft
- (3) Super-bright LEDS with on/off button



EMF-1

Part #	Mfg #	Description	Price
134816	EMF-1	LED Telescopic Flashlight	

Batteries

Part #	Mfg #	Description	Price
134817	FB-1	(4) Batteries for EMF-1	

Magnetic Stick Light

- Pocket-sized floodlight
- Magnet in handle
- Molded clip keeps in pocket
- Rugged, water resistant
- (6) Super-bright LEDS
- 36 Lumen output
- Runs more than 10 hours



Part #	Mfg #	Description	Price
145098	MSL-1	Magnetic Stick Light	

Pocket Area LED Light

- Ratcheting hinge angles light as needed
- Hanging hook swivels 360°
- Powerful magnet attaches securely to a horizontal or vertical surface
- (18) Super-bright LEDS
- Runs more than 6 hours
- Easy on/off - open/close

Part #	Mfg #	Description	Price
145267	PAL-1	Pocket Area Light	

Tools

Hammers

Hammers

Sheet Metal Hammer - Riveting

- Polished finish



Part #	Mfg #	Size	Handle	Head Weight	Price
006477	RH4	4-7/8"	Leather	12 oz	

Sheet Metal Hammer - Setting

- Polished finish



Part #	Mfg #	Size	Handle	Head Weight	Price
006482	SH3	5-1/2"	Leather	18 oz	

Hammers

Hammers

Hammer



Ball Pein



Ripping Claw



Part #	Mfg #	Model	Description	Head Weight	Overall Length	Price
008654	52455	016	Ball Pein	16 oz	14"	
008705	52485	216	Ripping Claw	16 oz	13-1/4"	

Tools

Hand Sewer Machines

Petersen Drain Flushers

- Multi-flex™ multiple ply construction, high flow rate flushing
- Flexible for insertion around bends, internal stiffener for easy insertion
- 3/4" Water hose coupling

Petersen



R193400



R193600



R193700

Part #	Mfg #	Description	Price
008378	R193400	102-001 1-1/2" Drain Jet	
008380	R193600	102-003 3" Drain Jet	
008904	R193700	102-004 4" Drain Jet	

Suction Guns

Part #	Mfg #	Description	Price
080436	R441825	Last Drop Suction Gun	



Hand Sewer Machines

Clog Buster™ Drain Flushers



Part #	Mfg #	Size	Price
002966	303135	1-1/2" - 3"	

Tools



Hand Sewer Machines

Flexicore® Closet Augers

Regular Head Closet Auger

- With Flexicore double layer wire rope center



3FL



T6FL

Part #	Mfg #	Description	Price
093674	3FL	3' Flexicore (6/Ctn)	
005064	T6FL	6' Teletube Flexicore	

Down Head Closet Auger

- Flexicore double layer wire rope center

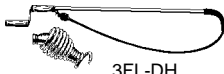

3FL-DH



T6FL-DH

Part #	Mfg #	Description	Price
005068	3FL-DH	3' Flexicore	
005063	T6FL-DH	6' Teletube Flexicore	

Urinal Augers



Part #	Mfg #	Description	Price
038683	TU4	Telescoping Teletube® - 48" Spring (6/Ctn)	



Hand Sewer Machines

Drain Cleaning & Tools

Mighty Mini Sink Plunger

- 4" Black rubber cup
- 8" Plastic handle
- Barcode label



Part #	Mfg #	Description	Price
053480	090288	Mighty Mini Sink Plunger	

All Angle Power Plunger

- Flexible black rubber cup with 21" yellow handle
- Fully assembled with header card



Part #	Mfg #	Description	Price
041779	090300	Power Plunger	



Hand Sewer Machines

Plungers



Part #	Mfg #	Description	Price
008174	93-8	Korky® Plunger	



Hand Sewer Machines

Snake-Oil™

- *Highly recommended for use with all types of cables*



Part #	Mfg #	Description	Price
010265	SOQ-12	1 qt, 12/Pk	

Tools

Hand Sewer Machines

Plungers

Rubber Plunger

- Includes funnel-shaped cap that is retractable for use in flat sinks



Part #	Mfg #	Type	Handle	Price
183404	312-2	Funnel	20"	

Hole Saws

Hole Saws

Bi-Metal Hole Saws

- TUFF TOOTH™ design is reinforced to cut stronger and last longer
- Patented VARI-TOOTH® design resists tooth stripping
- High speed steel teeth resist breaking and offer extended life



Use Arbor 1L, 1SL, 4L or 5L

- (1) Per box

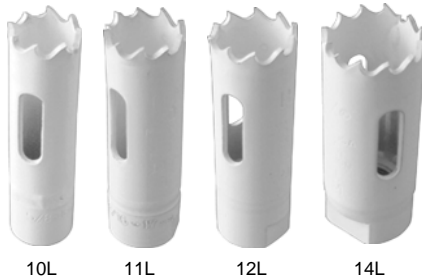

Part #	Mfg #	Dia	Pipe Tap	Pipe Entr	Price
089115	30010-10L	5/8"	-	-	
078170	30011-11L	11/16"	-	-	
006288	30012-12L	3/4"	1/2"	3/8"	
006294	30014-14L	7/8"	3/4"	1/2"	
006296	30016-16L	1"	-	-	
006298	30018-18L	1-1/8"	1"	3/4"	

Use Arbor 2L, 2SL, 3L or 6L

- (1) Per box

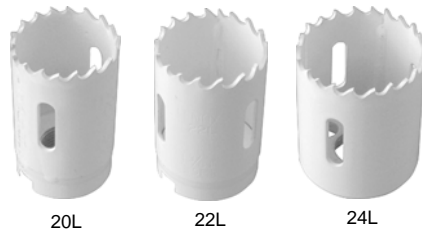

Part #	Mfg #	Dia	Pipe Tap	Pipe Entr	Price
006300	30020-20L	1-1/4"	-	-	
006304	30022-22L	1-3/8"	-	1"	
006307	30024-24L	1-1/2"	1-1/4"	-	

Use Arbor 2L, 2SL, 3L, 6L or 7L

- (1) Per box

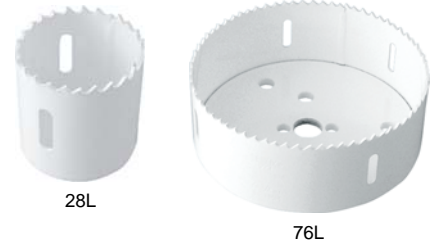

Part #	Mfg #	Dia	Pipe Tap	Pipe Entr	Price
006308	30026-26L	1-5/8"	-	-	
006309	30028-28L	1-3/4"	1-1/2"	1-1/4"	
006311	30030-30L	1-7/8"	-	-	
006318	30032-32L	2"	-	1-1/2"	
006324	30034-34L	2-1/8"	-	-	
006325	30036-36L	2-1/4"	2"	-	
080342	30038-38L	2-3/8"	-	-	
006329	30040-40L	2-1/2"	-	2"	
074661	30041-41L	2-9/16"	-	-	
006333	30042-42L	2-5/8"	2-1/2"	-	
006336	30044-44L	2-3/4"	-	-	
006337	30046-46L	2-7/8"	-	-	
006341	30052-52L	3-1/4"	3"	-	
006342	30056-56L	3-1/2"	-	-	
006344	30058-58L	3-5/8"	-	3"	
006346	30060-60L	3-3/4"	3-1/2"	-	
006355	30064-64L	4"	-	-	
006357	30066-66L	4-1/8"	-	3-1/2"	
006359	30068-68L	4-1/4"	4"	-	
006361	30072-72L	4-1/2"	-	-	
006362	30076-76L	4-3/4"	4-1/2"	-	
020254	30080-80L	5"	-	-	
045591	30096-96L	6"	-	-	

Carbide Tipped Hole Saw - Lenox® Blue

- Cuts abrasive materials, lasts up to 10 times longer than standard
- Uses standard arbors, recommend carbide tipped pilot drill

Use Arbor 1L, 1SL or 4L

- (1) Per box



Part #	Mfg #	Dia	Pipe Tap	Pipe Entr	Price
006297	30218-18CT	1-1/8"	1"	3/4"	

Hole Saws

Use Arbor 2L or 2SL

• (1) Per box

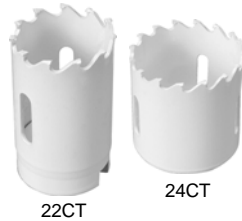

Part #	Mfg #	Dia	Pipe Tap	Pipe Entr	Price
045833	30220-20CT	1-1/4"	-	-	
006303	30222-22CT	1-3/8"	-	1"	
022412	30224-24CT	1-1/2"	1-1/4"	-	

Use Arbor 2L, 2SL or 7L

• (1) Per box

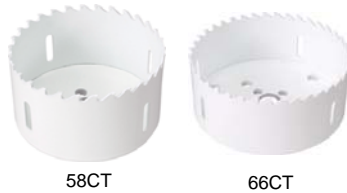

Part #	Mfg #	Dia	Pipe Tap	Pipe Entr	Price
006328	30240-40CT	2-1/2"	-	2"	
065796	30241-41CT	2-9/16"	-	-	
043574	30258-58CT	3-5/8"	-	3"	
099663	30264-64CT	4"	-	-	
033467	30266-66CT	4-1/8"	-	3-1/2"	

Diamond™ Hole Saw - 1-Piece

- For use on tile and stone
- Continuous brazed edge
- Over-sized slot in hole saw for easy plug removal
- No arbor required



Part #	Mfg #	Dia	Pipe Tap	Pipe Entr	Price
118297	121074DGDS	1/4"	-	-	
118303	1211416DGDS	1"	-	-	
118304	1211622DGDS	1-3/8"	-	1"	
118309	1211722DGDS	1-3/8"	-	-	
118310	1211824DGDS	1-1/2"	-	-	

Hole Saw Arbor

• 7L "Ejector Arbor" makes removal of material from inside of hole saw easier



Part #	Mfg #	Fits Hole Saws	Size	Shank	Price
006284	1779774	1L	9L-19L	1/2" Hex	
006299	1779801	2L	20L-96L	1/2" Hex	
006310	1779802	3L	20L-96L	1/2" Hex	
006327	1779803	4L	20L-96L	1/2" Solid/Hex	
006339	1779804	5L	9L-19L	3/8" Hex	
006345	1779805	6L	20L-96L	3/8" Hex	

Pilot Drill Bit



Part #	Mfg #	Fits Arbor #	Chuck Size	Pack	Price
058242	30297-123CT	1L,2L,4L,7L	1/4"	1	
006335	1779771	1L, 2L, 4L	1/4"	1	
006343	1779810	3L,5L,6L,7L	1/4"	25	

T-2 Technology Snap-Back™ Arbor

- Hex shank
- Faster and easier to engage/disengage hole saw
- Drives off pins, not threads
- No tools needed - prevents hole saw from locking on arbor
- Arbor threads directly into all hole saws



Part #	Mfg #	Fits Hole Saws	Thread Size	Price
125100	1779772	20L-96L	5/8"-18	
125101	1779669	9L-19L	1/2"-20	
125102	1779670	20L-96L	5/8"-18	

Tools

Hole Saws

One Tooth™ Wood Hole Cutter

- 3 Times faster than regular hole saws
- Safer/less torque than self feed bits
- Easy plug ejection
- Cuts wet, frozen, pressure treated and hard wood without binding
- Can be resharpened



Part #	Mfg #	Cutter Size	Price
061649	25434-34HC	2-1/8" for 1-1/2" Pipe, Lock Installation	
058041	25436-36HC	2-1/4" for 1-1/2" Pipe & 45°/90° Bend Couplings	
061648	25441-41HC	2-9/16" for 2" Pipe	
058043	25444-44HC	2-3/4" for 2" Pipe & 45°/90° Bend Couplings	
058044	25456-56HC	3-5/8" for 3" Pipe	
058045	25464-64HC	4" for 3" Pipe & Coupling, Dryer Vent	
058046	25474-74HC	4-5/8" for 4" Pipe	
058047	25480-80HC	5" for 4" Pipe & Coupling	
060636	25310-SB38	3/8" Stubby Spade Bit	
060634	25312-DIAF1	Diamond Sharpener File	

Bi-Metal Hole Saw Kit

- Designed for professional trades
- Plumbers Large Kit
- Includes:
 - (1) ea 3/4", 7/8", 1-1/8", 1-1/2", 1-3/4" and 2-1/4" Hole saws
 - (2) Arbors 2L and 5L
 - (1) 4321 Pilot drill
 - (1) Arbor adaptor
 - Plastic case



Part #	Mfg #	Description	Price
006347	30808-600P	10-Piece Large Hole Saw Kit	

Plumbers Medium 10-Piece Kit

- Includes:
 - (1) ea 3/4", 7/8", 1-1/8", 1-3/8", 2" and 2-1/2" Hole saws
 - (2) Arbors 2L and 5L
 - (1) 4321 Pilot drill
 - (1) Arbor adaptor
 - Plastic case



Part #	Mfg #	Description	Price
114142	30860-600CGP	10-Piece Plumbers Hole Saw Kit	

Electricians 10-Piece Hole Saw Kit

- Includes:
 - (1) ea 7/8", 1-1/8", 1-3/8", 1-3/4", 2" and 2-1/2" Hole saws
 - (2) Arbors: 2L and 5L
 - (1) 4321 Pilot drill
 - (1) Arbor adaptor
 - Plastic case



Part #	Mfg #	Description	Price
020550	30800-600L	Hole Saw Kit	

General Purpose - 26-Piece Kit

- Includes:
 - (1) ea 1-1/2", 1-3/4", 2", 2-1/8", 2-1/4", 2-1/2", 2-11/16", 3", 3-1/4", 3-3/8", 3-5/8", 3-3/4", 4-1/8", 4-1/2" and 4-3/4" Hole saws
 - (3) Arbors: 1L, 2L, 5L
 - (2) 4321 and (1) 56PD Pilot drills
 - Plastic case



Part #	Mfg #	Description	Price
059480	30804-2000G	Big Daddy™ Hole Saw Kit	

Carbide Tipped Hole Saw Kits

- Designed for professional trades
- 17-Piece Plumbers
- Includes:
 - (1) ea 3/4", 7/8", 1-1/8", 1-1/2", 1-3/4", 2-1/4", 2-9/16", 3", 3-1/2", 4", 4-1/4" and 4-1/2" Hole saws
 - (2) Arbors: 2L and 5L,
 - (2) 4321 and (1) 56 PD Pilot drill
 - Plastic case



Part #	Mfg #	Description	Price
062471	30801-1200P	Bi-Metal Hole Saw Kit	

Hole Saw Accessories

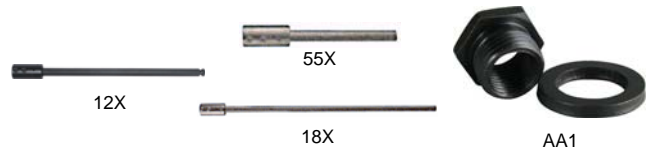

Part #	Mfg #	Description	Price
006312	30846-55X	5-1/2" Extension	
036486	30843-10X	10" Extension Fits 3/8" & Larger Drill Chucks For 5L or 6L Arbors	
006313	30847-12X	12" Extension	
006314	30848-18X	18" Extension	
006315	30857-AA1	Arbor Adaptor	

Tools

Hole Saws

Hole Cutter Kits

7-Piece Big Hawg® Hole Cutter Kit

- Designed for drilling large holes in rough wood
- Cuts up to 600 holes in wood without needing to be re-sharpened
- (3) Hardened steel teeth
- Deep gullet
- Includes:
 - (3) Hole cutters: 2-1/8", 2-9/16", 3-5/8"
 - Arbor with pilot bit
 - (2) Pilot bits
 - (1) Diamond file
 - (1) Hex wrench
- Impact-resistant case with additional storage space



Part #	Mfg #	Description	Price
137896	49-56-9075	7-Pc Big Hawg® Kit	

8-Piece Big Hawg® Hole Cutter Kit

- Includes:
 - (4) Hole saws - 2-1/8", 2-9/16", 3-5/8", 4-5/8"
 - Arbor with Big Hawg® pilot bit (49-56-9105)
 - (2) Big Hawg® Pilot bits (48-27-1401)
 - Diamond file
 - Hex wrench



Part #	Mfg #	Description	Price
138844	49-56-9080	8-Pc Big Hawg® Hole Cutter Kit	

Hole Saw Kits

8-Piece Ice Hardened™ Hole Saw Kit

- Ice Hardened™ for up to 50% longer life
- Includes:
 - (5) Hole saws: 3/4", 7/8", 1", 1-1/8", 1-1/2"
 - Twist-Release™ arbor with pilot bit: 49-56-7210
 - Additional pilot bit: 49-56-8010
 - 1/8" Hex Key
 - Adapter: 49-56-6560



Part #	Mfg #	Description	Price
150075	49-22-4005	8-Pc General Purpose Hole Saw Kit	

10-Piece Plumber's Ice Hardened™ Hole Saw Kit

- Includes:
 - (6) Hole saws: 3/4", 7/8", 1-1/8", 1-1/2", 1-3/4", 2-1/4"
 - (2) Arbors with pilot bits (49-56-7010 and 49-56-9100)
 - (2) Additional pilot bits (49-56-8010)
 - (1) Adapter (49-56-6560)
 - (1) Spacer (49-67-0120)



Part #	Mfg #	Description	Price
139022	49-22-4145	10-Pc Plumbers Ice Hardened™ Kit	

18-Piece Master Plumbers Ice Hardened™ Hole Saw Kit

- Cryogenically treated
- Optimized tooth form for up to 2 times faster cutting
- Wide, angled and offset slots
- Includes:
 - (13) Hole saws - 3/4", 7/8", 1-1/8", 1-3/8", 1-1/2", 1-3/4", 2-1/4", 2-5/8", 3", 3-1/2", 4", 4-1/4", and 4-1/2"
 - (2) Arbors with pilot bits (49-56-7010 and 49-56-9100)
 - (3) Additional pilot bits (49-56-6560)
 - (1) Spacer (49-67-0120)



Part #	Mfg #	Description	Price
139021	49-22-4155	18-Pc Master Plumber's Ice Hardened™ Hole Saw Kit	

28 PC All Purpose Professional Hole Dozer™ Hole Saw Kit

- Rip Guard™, the strongest tooth form in the industry
- Rip Guard™ limited lifetime tooth break warranty
- Plug Jack™, an all access slot design for fast plug removal
- Bi-metal construction with 8% cobalt for increased wear resistance



Part #	Mfg #	Description	Price
154644	49-22-4185	28 PC All Purpose professional Hole Dozer™ Hole Saw Kit	

Hole Saws

Hole Cutters

Big Hawg® Hole Cutter

- Designed for drilling large holes in rough wood
- Arbors and pilot bit sold separately
- Cuts up to 600 holes in wood without needing to be re-sharpened



Part #	Mfg #	Diameter	Price
137886	49-56-9000	2-1/8"	
137887	49-56-9005	2-1/4"	
137888	49-56-9010	2-9/16"	
137889	49-56-9020	3"	
137890	49-56-9030	3-5/8"	
137891	49-56-9045	4-1/4"	
137893	49-56-9050	4-5/8"	
168565	49-56-9055	5-1/4"	
137894	49-56-9065	6-1/4"	

Hole Saws

Carbide Tipped Hole Saw

- Provides longer life and faster cutting
- Designed for cutting ceramic tile, flakeboard, fiberboard, fiberglass and wood
- Not recommended for metal



49-56-0623

Part #	Mfg #	Hole Dia	Price
165182	49-56-0623	5/8"	
165183	49-56-0753	3/4"	
165184	49-56-0873	7/8"	
165185	49-56-1003	1"	
165186	49-56-1123	1-1/8"	
165188	49-56-1253	1-1/4"	
165187	49-56-1373	1-3/8"	
165189	49-56-1503	1-1/2"	
165190	49-56-1623	1-5/8"	
165191	49-56-1753	1-3/4"	
165192	49-56-2003	2"	
165193	49-56-2123	2-1/8"	
165195	49-56-2253	2-1/4"	
165196	49-56-2503	2-1/2"	
165202	49-56-2623	2-5/8"	
165203	49-56-2753	2-3/4"	
165204	49-56-2873	2-7/8"	
165205	49-56-3003	3"	
165206	49-56-3253	3-1/4"	
165207	49-56-3503	3-1/2"	
144973	49-56-3623	3-5/8"	

Hole Saws (Continued)

Carbide Tipped Hole Saw

Part #	Mfg #	Hole Dia	Price
165208	49-56-3753	3-3/4"	
154873	49-56-4003	4"	
144972	49-56-4253	4-1/4"	
165209	49-56-4503	4-1/2"	
165210	49-56-5003	5"	
165211	49-56-6003	6"	

Hole Dozer™ Hole Saw

- Rip Guard™, the strongest tooth form in the industry
- Plug Jack™, an all access slot design for fast plug removal
- Bi-metal construction for increased wear resistance



Part #	Mfg #	Description	Price
165164	49-56-0012	5/8"	
152110	49-56-0023	3/4"	
152111	49-56-0032	7/8"	
165165	49-56-0017	1 1/16"	
152112	49-56-0043	1"	
165166	49-56-0047	1-1/16"	
152113	49-56-0052	1-1/8"	
152114	49-56-0062	1-1/4"	
152115	49-56-0072	1-3/8"	
152116	49-56-0082	1-1/2"	
165167	49-56-0092	1-5/8"	
165178	49-56-0112	1-7/8"	
152117	49-56-0127	2-1/8"	
151231	49-56-9630	2-3/8"	
165168	49-56-0153	2-9/16"	
153383	49-56-0163	2-3/4"	
165170	49-56-0167	2-7/8"	
165171	49-56-0177	3-18"	
165172	49-56-0183	3-1/4"	
165173	49-56-0203	3-3/4"	
165174	49-56-0217	4-1/8"	
165175	49-56-0223	4-1/4"	
165176	49-56-0237	4-3/4"	
165177	49-56-0253	6"	

Hole Saws

Ice Hardened™ Hole Saw

- Ice Hardened™ for up to 50% longer life



Part #	Mfg #	Size	Price
143992	49-56-0102	1-3/4"	
144015	49-56-0117	2"	
144016	49-56-0147	2-1/2"	
150074	49-56-0158	2-5/8"	
144017	49-56-0173	3"	
148183	49-56-0193	3-1/2"	
144018	49-56-0197	3-5/8"	
144019	49-56-0233	4-1/2"	
142700	49-56-0243	5"	

Diamond Plus™ Hole Saw

- Diamond Plus™ greater durability and toughness delivers up to 10X longer life
- Higher grade diamonds and improved braze: Provides best-in class performance
- Large slug ejection slot
- Versatile: Ideal for cutting anchoring and clearance holes in all tile, stone and glass



Part #	Mfg #	Description	Price
173242	49-56-0505	1/4" Diamond Plus™ Hole Saw	
173243	49-56-0507	5/16" Diamond Plus™ Hole Saw	
173244	49-56-0515	3/4" Diamond Plus™ Hole Saw	
173245	49-56-0426	1-3/8" Carbide Grit Hole Saw	

Core Bit With Center Bit

- Long life: Abrasion-resistant carbide teeth increase cutter life and produce a cleaner cut
- Accurate cuts: Centering bit eliminates slipping for accurate hole placement and dimensions
- Versatile design: Use with 11" extension for extra-deep drilling applications
- Multipurpose SDS-MAX or spline shank: Interchangeable with a variety of drilling heads from 1-1/2" to 5"



Part #	Mfg #	Description	Price
166215	48-20-5092	2-1/8" Core Bit With Center Bit	

SDS-Max and SPLINE Thick Wall Carbide Tipped Core Bit

- Thick Wall Design
- Use with 12" or 18" SPLINE adapter shanks (48-00-3564, 48-03-3565) and 12" or 18" SDS-Max adapter shanks (48-03-3572, 48-03-3573)
- Use with 7-1/2" extension 48-95-6085
- Use with guide plate 48-20-5174 and centering pin 48-20-5199
- Includes core body with guide plate & centering pin



Part #	Mfg #	Description	Price
164477	48-20-5130	SDS-MAX and SPLINE Thick Wall Carbide Tipped Core Bit 1-3/4"	
159714	48-20-5140	SDS-MAX and SPLINE Thick Wall Carbide Tipped Core Bit 2-1/2"	
155357	48-20-5150	SDS-MAX and SPLINE Thick Wall Carbide Tipped Core Bit 3-1/2"	
162578	48-20-5155	SDS-MAX and SPLINE Thick Wall Carbide Tipped Core Bit 4"	

Hole Saws

SDS-PLUS Thin Wall Carbide Tipped Core Bit

- Thin wall design
- 2" Diameter
- Usable cutting depth 2-13/16"
- Use with 8" or 12" SDS PLUS adapter shanks (48-03-3555, 48-03-3561)
- Use with 7-1/2" extensions 48-95-6075
- Use with guide plate 48-20-6157 and centering pin 48-20-6155
- Includes core body with guide plate & centering pin



Part #	Mfg #	Description	Price
163505	48-20-5035	SDS-PLUS Thin Wall Carbide Tipped Core Bit 2"	
163506	48-20-5050	SDS-PLUS Thin Wall Carbide Tipped Core Bit 3-1/2"	

Diamond Core Bit Pre-Stress

- Maximum speed: Segment design allows coring at higher RPM
- High quality: Segments are silver-brazed for exceptional holding strength
- Versatile: Effectively cores pre-stressed and steel reinforce concrete, and asphalt



Part #	Mfg #	Description	Price
159936	48-16-6014	6" Diamond Core Bit Pre-Stress	

Thin Wall Hole Saw

- 1/4" Quick change hex shank for use with impact drivers
- Thin wall 8 TPI design for 40% faster cuts than standard bi-metal hole saws
- Stop shoulder design prevents over drilling and damaging components
- Ejection spring automatically removes slugs



Part #	Mfg #	Description	Price
169268	49-56-9805	3/4" Thin Wall Hole Saw	
169269	49-56-9810	7/8" Thin Wall Hole Saw	
169270	49-56-9815	1" Thin Wall Hole Saw	
169271	49-56-9820	1-1/8" Thin Wall Hole Saw	
169272	49-56-9825	1-1/4" Thin Wall Hole Saw	
169273	49-56-9830	1-3/8" Thin Wall Hole Saw	
169274	49-56-9835	1-1/2" Thin Wall Hole Saw	

Arbors

3/8" Small Arbor

- Durable hardened steel construction
- Fits all hole saws up to 1-3/16"
- Fits all drill chucks 3/8" and larger



Part #	Mfg #	Size Range	Shank Size	Price
144976	49-56-7010	Up to 1-3/16"	3/8"	

Big Hawg® Arbor

- Standard 5/8"-18 thread fits all hole saws or hole cutters 1-1/4" through 6-1/4"
- Includes:
 - (1) Flat boring pilot bit
 - (1) Big Hawg® Arbor
 - (1) 7/16" Quick change shank



Part #	Mfg #	Description	Price
137895	49-56-9105	Big Hawg® Arbor	

Large Quick Change Arbor

- Tool-free operation
- Universal, quick change with all brands of hole saws
- No adapters required
- Hardened steel construction
- Fits all hole saws 1-1/4" and larger
- Fits all drill chucks 3/8" and larger



Part #	Mfg #	Size Range	Shank Size	Price
144975	49-56-7250	1-1/4"+	3/8"	
149219	49-56-9100	1-1/4"+	7/16" No Wobble	

Pilot Drill Bits

Big Hawg® Hole Cutter Pilot Bit

- Machined cutting edge for increased cutting speed
- Exclusive bit geometry aids plug removal



Part #	Mfg #	Description	Price
137898	48-27-1401	Big Hawg® Center Spade Bit	



Hole Saws

Hole Saw Accessories

Universal Quik-Lok™ Extension

- Accepts all 7/16" shanks
- No tools required for bit change
- Impact rated



Part #	Mfg #	Size	Price
144978	48-28-1000	3" x 1/4"	
152998	48-28-1030	5-1/2" x 7/16"	

Hex Extension

Part#	Mfg #	Description	Price
138372	48-28-1010	6" Hex Extension	
138373	48-28-1020	12" Hex Extension	

Right Angle Attachment

- Rated up to 235 in/lbs torque
- Accepts standard 1/4" hex shank bits



Part #	Mfg #	Description	Price
149497	49-22-8510	Right Angle Attachment	

Files

Big Hawg® Diamond File

- Easy re-sharpening on job site



Part #	Mfg #	Description	Price
137897	48-95-5055	Big Hawg® Diamond File	

HVAC Testing Tools

Motor Testers

TECMate Pro ECM Motor Tester

- Analyze ECM motors independent of the HVAC system
- Operates in the basic HVAC settings of fan-only, heating, cooling and de-humidification
- Designed to detect and isolate motor failures from other HVAC system failures



Part #	Mfg #	Description	Price
153548	PD510009	TECMate Pro Motor Tester	

Test Connector

Part #	Mfg #	Description	Price
031520	45-24318-01	Test Connector	

Circuit Protection Products

ZBreaker Circuit Breaker Set



Part #	Mfg #	Description	Price
141508	ZK005	5 Amp	

Short-Pro Tool™

- Finds 24 volt system shorts
- Automatically resets the breaker
- (2) 18" Leads



Part #	Mfg #	Description	Price
140758	ZSPRT	Short-Finder	

Safety Power Adapters

Zebra'Dapter Fused Power Tap Cord

- Lighted to show voltage level of plug
- Safe way to obtain 120V power to vacuum pumps, charging scales, drop lights, etc.



Part #	Mfg #	Description	Price
140729	ZD002	2' Lighted Female Cordset Blue	
140728	ZD001	2' Lighted Male Cordset Yellow	

Smoke Detector & Accessories

SL-2000 Duct Smoke Detector

- Hi-Temp
- Low-Flow
- No Tools



Part #	Mfg #	Description	Price
118470	SL-2000-N	4-Wire Ionization	

Sampling Tube for SL-2000 & RT-3000 Series



Part #	Mfg #	Description	Price
118471	STN-2.5	12" to 3.0'	

Meters

Thermo-Psychrometer

- Large storage area for probes
- TM350 Includes:
 - (1) TMX2A 15' Air probe
 - (1) TMX2G 15' General purpose
 - (1) TMX2S 15' Surface probe



Part #	Mfg #	Description	Price
143080	87-TM350	Four Remote Stations	

Tools

HVAC Testing Tools

Probe for TM350 Thermo-Psychrometer



TMX2S

Part #	Mfg #	Description	Price
143081	87-TMX2C	Clamp-On	
143082	87-TMX2P	Puncture	
143083	87-TMX2S	Surface	

Hardware

Alligator Clip

Part #	Mfg #	Description	Price
140494	455055	1" Black, 6/Pk	
140495	455056	1" Red, 6/Pk	
140496	455057	Alligator Clips with 18 AWG - 36" Test Leads	

Test Lead

Part #	Mfg #	Description	Price
140609	455150	10 AWG, 36" with 10A Clip	

HVAC Testing Tools

Voltage Detectors

Voltage Detector with LED

- Can detect between 50 and 1,000VAC
- Safety rating: CAT IV 1,000V
- Green power on indicator light
- Pocket clip
- Requires (2) AA batteries (included)



Part #	Mfg #	Description	Price
137565	2202-20	Voltage Detector w/LED	

Dual Range Voltage Detector

- Different colors identify voltage range
- Built-in LED work light
- Auto-off
- Pocket clip
- Blade-tip for checking outlets
- Constant power ON LED indicator



Part #	Mfg #	Description	Price
168492	2203-20	Dual Range Voltage Detector	

Test & Measurement Tools

Fork Meter for HVAC/R

- Heavy-duty True-RMS electrical tester for professional residential, commercial and industrial applications
- High contrast white-on-black display
- Five tools in one:
 - Current measurement
 - Temperature measurement
 - Voltage measurement
 - Voltage detection
 - Task lighting - LED work light
- Includes:
 - Fork clamp
 - Test leads
 - Dual banana thermocouple
 - (2) AA Batteries
 - Manual
- 5-Year warranty



Part #	Mfg #	Description	Price
137566	2206-20	Fork Meter Kit for HVAC/R	

Digital Multimeter

- Wide voltage range to 600VAC/DC
- Auto range to millivolts
- True-RMS for accurate measurement in all applications
- Lo-Z measurement to eliminate ghost voltage
- Frequency measurements from 10Hz to 50kHz
- Contact temperature measurement: -40° to 752°F
- Current measurement to 10AAC/DC
- High contrast white on black display with back light
- Rugged over-molding increases durability and user grip
- 5-Year warranty
- Includes:
 - Multimeter
 - Test leads
 - Dual banana thermocouple
 - (2) AA Batteries
 - Manual



Part #	Mfg #	Description	Price
136067	2217-20	Digital Multimeter Kit	

Clamp Meter for HVAC/R

- Electrical current tester for professional residential, commercial and industrial applications
- 1.3" Jaw opening to easily handle large conductors
- White-on-black display
- LED Work light
- Includes:
 - Clamp
 - Test leads
 - Dual banana thermocouple
 - (2) AA Batteries
 - Manual
- 5-Year warranty



Part #	Mfg #	Description	Price
137567	2236-20	Clamp Meter for HVAC/R	



HVAC Testing Tools

Meter Case

- Case constructed of rugged nylon
- Three sided zipper closure
- One inside pocket for a manual and one main compartment for a meter
- Strong nylon strap with snap closure for hanging from belt
- All the following Milwaukee meters fit in this case:
 - 2205-20 Fork meter
 - 2206-20 Fork meter for HVAC/R
 - 2216-20 Digital multimeter
 - 2217-20 Digital multimeter
 - 2235-20 400amp clamp meter
 - 2265-20 Laser temp-gun
 - 2266-20 Laser temp-gun



Part #	Mfg #	Description	Price
164509	48-55-0175	Meter Case	
164510	48-55-0180	Large Meter Case	

HVAC Testing Tools

Meters & Testers

Vane Anemometer

- Air humidity meter with temperature measurement
- Integrated measurement with 1.5 in. vane
- Timed mean value calculation
- Hold function and max./min. values
- Wind chill calculation for outside areas (perceived temperature)
- Back lit display
- Air humidity measurement with long-term stable Testo humidity sensor
- Incl. dewpoint calculation and wet bulb
- Includes:
 - Integrated humidity measurement and NTC air thermometer
 - Protective cap for safe storage
 - Wrist strap and belt clip
 - (2) Type AAA batteries, 60 hour life
 - Calibration certificate



Part #	Mfg #	Description	Price
143078	875043	Vane Anemometer with Integrated Humidity & NTC Air Thermometer	

Carbon Monoxide Stick Meter

- Detects presence of carbon monoxide in ambient air from gas furnaces, water heaters, and other appliances or equipment
- Visual and audio warnings, adjustable alarm threshold
- No zero phase, instrument can be used immediately
- CO Zeroing on-site
- Self test function



Part #	Mfg #	Description	Price
143084	875036	Includes Leather Holster w/Belt Strap, Earphone, Wrist Strap	

Humidity and Temperature Meter

- Long-term, stable Testo humidity sensor
- +/-2.5 %RH Accuracy
- Hold function and max/min values
- Includes:
 - Protective cap for safe storage
 - Batteries
 - Calibration certificate



Part #	Mfg #	Description	Price
143079	875042	Dewpoint & Wet Bulb Meter	

Electrical

Part #	Mfg #	Description	Price
141560	86-22510	Test Leads	

Tools

HVAC Testing Tools

Clamp-On Digital Multimeters

DL389 G2 Phoenix Pro+ Clamp-On Multimeter

- Dual display and low battery display lock
- Test lead storage and holder on clamp head
- Auto off
- Input jack lock
- Detachable clamp head
- Worklight
- Magnetic mount
- User temperature calibration
- EasyView high contrast backlight display
- Compatible with common industry accessories heads
- Safety compliance CAT III 600V, CAT II 1000V
- Includes:
 - Test leads
 - K-Type probe (no adapter required)
 - Zippered case
 - (2) AAA Batteries
- 3-Year limited warranty



Part #	Mfg #	Description	Price
128764	DL389	12 Functions Including TRUE-RMS (AC Volts & Amps)	

Thermometers

550B Digital Pocket Thermometer

- Water resistant
- Records minimum & maximum temperatures
- Protective boot
- Magnetic mount
- HOLD freezes the current temp reading
- Auto power off
- Ergonomic designed head
- 3-Year limited warranty



Part #	Mfg #	Description	Price
069651	550B	-58° to 572°F Range	

PDT550 Digital Pen Type Thermometer

- Waterproof
- Built-in magnetic mount
- Records minimum & maximum temperatures
- Data hold
- Auto power off
- Easy access battery compartment
- Enhanced accuracy of digital circuitry
- Includes battery & multipurpose probe
- 3-Year limited warranty



Part #	Mfg #	Description	Price
082376	PDT550	-58° to 572°F Range	

CO Detectors

CO71 "The CO Detective" Carbon Monoxide Monitor

- Tri-color LED indicates concentrations at 3 levels complying with residential and work place standards
- Audible alert triggers at 35 ppm indicating the threshold of dangerous concentration
- Backlight display
- Operating temperature: 32° to 104°F
- MAX Continually updates to provide recall of highest CO reading
- Auto zero activates upon turn on
- 9V Battery operated
- 3-Year limited warranty



Part #	Mfg #	Description	Price
051760	CO71	Displays 0 to 999 ppm CO Level in Ambient Air	

Leak Detectors

CD100A Combustible Gas Leak Detector

- Long 18" gooseneck for hard to reach areas
- Tip light in sensor cap illuminates search area
- Probe cage protects sensor
- Audio and visual tic rate fully adjustable
- Headphone jack
- Includes:
 - Sensor and cap
 - 9V Battery
- 1-Year limited warranty



Part #	Mfg #	Description	Price
038331	CD100A	50 ppm Minimum Detection	

HVAC Testing Tools

Manometers

EM151 Digital Electronic Manometer

- Single input measurement to $\pm 20"$ wg
- Integral protective boot w/magnet
- Simple two-button operation
- Measures in inches water gauge and Mbar
- Automatic after 5 minutes of inactivity and manual power-off
- Includes:
 - (1) Pressure tubes with brass fitting connector
 - (1) Std 9V battery
 - Manual
- 1-Year limited warranty



Part #	Mfg #	Description	Price
126553	EM151	Single Input Electronic Manometer	

SSM1 Super Heat/Sub Cool Meter

- Measures:
 - Pressure from 0 - 500 psia
 - Temperature from -40° to 400°F
- Calculates:
 - Superheat for low side
 - Subcool for high side (TXV systems)
- Refrigerants included for calculations: R-22, R-134a, R-404A, and R-410A
- 1-Year limited warranty



Part #	Mfg #	Description	Price
133479	SSM1	Super Heat/Sub Cool Meter	

Electrical Testers

PET1 Pocket Electrical Tester

The PET1 features:

- Worklight
- Non-contact AC voltage test from 12-600VAC (with adjustable sensitivity)
- Detects high and low AC voltage
- Continuity check: 0-80 megohms
- Audible/visual indicators
- 3-Year limited warranty



Part #	Mfg #	Description	Price
083035	PET1	Volt Tester w/Light	

Tools

HVAC Testing Tools

Meters

Economy Auto-Ranging Clamp-On Meter

- Reads volts, amps and ohms
- Data hold and continuity buzzer
- CAT II
- Includes carrying case



Part #	Mfg #	Description	Price
111388	MA-600CF	Temp Range: -38° to 1,750°F	

Oil & Glycol Refractometer



Part #	Mfg #	Description	Price
111392	MA-REF401F	Glycol Fahrenheit Refractor	

HVAC Testing Tools

Electrical Testers

Non-Contact Voltage Tester

- High intensity, bright green LED indicator when on
- High intensity, bright red LED indicator when voltage is detected
- Package contains insert card with integrated owner's manual and (2) AAA 1.5V batteries



Part #	Mfg #	Description	Price
125141	NCVT-1	50 - 1000VAC	

Dual Range Non-Contact Voltage Tester

- Automatically detects and indicates:
 - Low voltage (12-48VAC)
 - Standard voltage (48-1000VAC)
- High intensity, bright green LED indicates the tester is operational and aids in illuminating the workspace
- Digitally controlled ON/OFF power button
- Auto power-off feature conserves and extends battery life
- Microprocessor controlled low-battery indicator
- CAT IV 1000V Rating
- Lightweight, durable polycarbonate plastic resin construction; convenient pocket clip



Part #	Mfg #	Description	Price
137459	NCVT-2	50 - 500Hz	

Clamp Meters

CL200 Professional Series Clamp Meter

- Worklights illuminate dark work spaces
- Backlit display
- Data hold captures measurements in any situation
- Diode and continuity tests
- Includes test leads, batteries, case and thermocouple
- Measures temperature, frequency and capacitance
- 8.2"H x 3"W x 1.4"D



Part #	Mfg #	Description	Price
140679	CL200	1" Jaw, 600A AC w/Thermocouple	



HVAC Testing Tools

Meters

TurboMeter™

Part #	Mfg #	Description	Price
106684	439103	Air Velocity Meter	

Differential Pressure Meter

- Includes protective cap, batteries and calibration certificate
- Display in Pascal optional over entire measurement range
- Temperature compensation
- Magnetic back permits free-hand work
- Accuracy: ± 0.01 "H₂O (0 to 0.12 "H₂O) / ± 0.02 "H₂O (0.13 to 0.4 "H₂O)
- Flow velocity measurement with Pilot tube (Pilot tube not included in delivery)
- Air density compensation
- Includes:
 - Protective cap for safe storage
 - (2) Type AAA Batteries, 50 hour life
 - Including wrist strap and belt clip



Part #	Mfg #	Description	Price
142784	875044	Digital Differential Pressure Meter	

Knives & Replacement Blades

Utility Knives

Lenox® Gold™ Quick Change Knife



GOLD5C, GOLD50D

Part #	Mfg #	Description	Price
084422	20353-SSRK1	Retractable Blade Knife with (3) Blades	

Blades

Part #	Mfg #	Description	Price
084423	20350-GOLD5C	Replacement Blades, 5/Pk	
089119	20351-GOLD50D	Replacement Blades, 50/Pk	

Lenox® Gold™ Locking Tradesman Utility Knife

- Easy open and close secure locking mechanism
- Ergonomic, rubberized comfort grip
- Multi-use tool; bottle opener, screwdriver and pipe reamer
- Built-in wire stripper



Part #	Mfg #	Description	Price
105776	10771	Locking Tradesman Utility Knife	

Knives & Replacement Blades

Utility Knives and Knife Blades

Quick Open Utility Knife

- Retractable blade
- Integrated hinge



Part #	Mfg #	Description	Price
048168	9PK	3-Position	

Top Button Action Utility Knife

- Safe, easy to operate thumb action mechanism on top



Part #	Mfg #	Description	Price
006528	4PK	3-Position	

Mini-Knife®

- Precision cuts clean and sharp
- Includes retractable blade



Part #	Mfg #	Description	Price
006525	3PKM	Mini-Knife®	

Knives & Replacement Blades

Utility Knives

Sliding Utility Knife

- Side slide activated blade
- Rubber over mold hand grip
- On board blade storage
- Tool-free blade change
- Integrated gut hook and wire stripper



Part #	Mfg #	Description	Price
137585	48-22-1910	Sliding Utility Knife	

18mm Snap Off Knife

- Durable lock- up to 2x longer life
- Speed thread- 2x faster blade adjustment
- Microcarbide blade- up to 2x longer blade life
- Acetone resistant
- 8 Point blade



Part #	Mfg #	Description	Price
163299	48-22-1964	18mm Snap Off Knife	

Fastback™ Utility Knife

- One-handed blade opening
- Tool-free blade change
- Wire stripper
- Integrated gut hook
- Thin body design



Part #	Mfg #	Description	Price
137584	48-22-1901	FASTBACK™ Flip Utility Knife	
225380	48-22-1903	FASTBACK™ Flip Utility Knife with Blade Storage	

FASTBACK™ Smooth Folding Pocket Knife

- Press and flip operation: Permits one-handed opening
- Stainless steel drop-point blade: resharpenable edge for long lasting use
- Liner lock
- Slim, compact body: stores easily yet withstands job site abuse
- Piercing tip: allows controlled piercing and smooth cutting
- Lanyard hole
- Reversible wire-form belt clip



Part #	Mfg #	Description	Price
163301	48-22-1990	FASTBACK™ Smooth Folding Pocket Knife	

FASTBACK™ Spring Assisted Serrated Knife

- Spring-assisted opening: Permits one-handed operation
- Black oxide-coated stainless steel serrated blade: Maintains long-lasting sharp edge
- Liner lock
- Serrated blade: Ideal for tearing through material, Tanto tip: Ideal for piercing material
- Slim, compact body: Stores easily yet withstands job site abuse
- Reversible wire-form belt clip



Part #	Mfg #	Description	Price
162813	48-22-1995	FASTBACK™ Spring Assisted Serrated Knife	

FASTBACK™ Hawk Bill Folding Knife

- Press-and-flip operation: permits one handed opening
- Stainless steel curved blade
- Liner lock
- Slim, compact body
- Piercing tip: allows controlled piercing and smooth cutting
- Lanyard hole
- Reversible wire-form belt clip



Part #	Mfg #	Description	Price
170008	48-22-1985	FASTBACK™ Hawk Bill Folding Knife	



Knives & Replacement Blades

50 PC General Purpose Utility Blades w/ Dispenser

- Micro carbide deposited metal delivers up to 3X longer life than standard carbon blades
- Precision grind process removes the burr from cutting edge for cleaner cuts
- Optimized grind angles deliver improved sharpness for less repeat cuts
- Made in the USA



Part #	Mfg #	Description	Price
163303	48-22-1950	50 PC General Purpose Utility Blades w/ Dispenser	

Bottle Opener

- Wire stripper- up to 12ga
- Chrome plated rust protection
- Hardened steel for durability
- Cushion grip handle
- Rear cap ID marking



Part #	Mfg #	Description	Price
165227	48-22-2000	Bottle Opener	

Knives & Replacement Blades

Putty Knives



Part #	Mfg #	Size	Price
096245	K50-015	1-1/4"	

Knives & Replacement Blades

Knives

Lightweight Lockback Knife - Drop-Point Blade with Pocket/Belt Clip

- Blade is AUS8 stainless hardened to 58-59 Rc
- Anodized aluminum finish on handle is silver with stainless steel blade or black with black-chrome blade
- Reversible thumb stud



Part #	Mfg #	Blade Length	Color	Price
117588	44001-BLK	2-1/2"	Black	

Utility Knives

Utility Blades

- Heavy-duty razor edged reversible



Part #	Mfg #	Description	Price
125646	44101	(5) Blades	

Double-Locking Folding Utility Knife

- Blade locks in both open and closed position
- Pocket/belt clip



Part #	Mfg #	Closed Length	Overall Length	Price
125645	44108	3"	6-1/8"	

Pocket Knives

2-Blade Lockback Pocket Knife - Drop Point & Screwdriver Tip Blades

- Anodized aluminum handle
- Thumb stud
- Includes removable pocket/belt clip

Part #	Mfg #	Description	Price
117581	44008	Stainless Steel	



Knives & Replacement Blades

Utility Knives and Blades

#82 Safety Nose Retractable Blade Knife

Part #	Mfg #	Description	Price
036760	38205	Heavy-Duty Red	

Tools

Levels

Levels

Torpedo Level

- Ideal for general use and work in tight places
- Three vials for plumb, level and 45° miter
- Full length strong magnetic edge
- V-Grooved edge for pipe and conduit work
- Large top read level vial



Part #	Mfg #	Model	Description	Price
051918	20233	395	9" Nightshade Level	

Levels

Levels

Torpedo Level

- Aluminum construction
- Professional quality



Part #	Mfg #	Description	Price
110080	J40-100	7-1/2" Length, Magnetic Sides	

Levels

Levels Pocket Level



- Strong molded plastic frame with pocket clip
- Multi view vial reads top, bottom or side
- Ideal for leveling thermostats

Part #	Mfg #	Length	# of Vials	Price
006443	L5	5"	1	

Levels

Levels



Part #	Mfg #	Description	Price
008910	R148700	ML-24	

Tools

Levels

Torpedo Levels

Aluminum Level

- *Lightweight, precision made*
- *Acrylic plastic yellow vials*



Part #	Mfg #	Description	Price
110504	930-9	9" Level, Plumb & 45°	

Heavy-Duty Level with Magnet

- *Allows hands-free measurements on iron or steel surfaces*
- *Features Rare Earth magnets and vial frames with E-Z-See™ glow-in-the-dark-material*



Part #	Mfg #	Description	Price
111224	931-9RE	9" Level, Plumb & 45°	

Torpedo Level

- *Large, high visibility vials are easy-to-read*
- *Rare Earth magnet*
- *Vials set for measurements at 0°, 30°, 45° and 90°*
- *Machined billet aluminum design*
- *High contrast laser etched markings*



Part #	Mfg #	Description	Price
125146	932-9RE	9" Level, Plumb, 30°, & 45°	

Miscellaneous Tools

Maxstraps

The Original 1" Polypropylene Cam Tiedown

- Ideal for lumber, pipe, ladders, and outdoor gear
- Weather and sunlight resistant
- 750 lb Test
- Rustproof cam buckle
- Easy thumb release



Part #	Mfg #	Description	Price
053091	00216	2' Black	
053093	00411	4' Red	
053094	00612	6' Yellow	
053095	00813	8' Green	
053096	01014	10' Blue	

Tools

Miscellaneous Tools

Utility Strap

Rubber Tie Down Strap

- Stretches to double its length
- Extra heavy steel S-hooks on each end



Part #	Mfg #	Description	Price
002270	540-31	31" Rubber Strap	

Fin Tools

Fin Whisk

- Plastic handled whisk for cleaning condenser and evaporator fins



Part #	Mfg #	Description	Price
141528	B-26	Fin Whisk Brush	

Miscellaneous Tools

Refrigerant Tools

Fin Tool Kit



Part #	Mfg #	Description	Price
130934	875001	Fin Tool Kit - 8, 9, 10, 11, 12, 14 Fin Heads	

Tools

Miscellaneous Tools

Telescoping Tools

Reach-It

- Retracts to 5" long, extends to 26-3/4"
- Chrome-plated brass



Part #	Mfg #	Description	Price
002268	R-1	Reach-it Tool	

Telescopic Inspection Mirror

- American made
- Double ball joint links swivel mirrors for viewing to 360°



Part #	Mfg #	Description	Price
002322	M-5	1" x 2" Oval Extends 8-1/2"	

Miscellaneous Tools

Tools

Pro-Set® Inspection Mirror



Part #	Mfg #	Description	Price
098914	87-TLMIR3	3.5" x 2.12" Rectangular Telescoping Mirror	

Batteries

Batteries - Alkaline

- Batteries all alkaline
- Attractive retail-type packaging



Part #	Mfg #	Description	Price
180520	BV900243	AA - 18 PK	
180522	BV900244	AAA - 18 PK	
180521	BV900245	9V - 4PK	

Tools



Miscellaneous Tools

Caulking Guns

Deluxe Caulking Gun

- Zinc-plated with tip-cutter and seal punch



Part #	Mfg #	Description	Price
028237	040025	Deluxe	

Miscellaneous Tools

Flue and Boiler Tube Brushes

Fine-Wire Single Spiral Brush

- For small boilers, burners, nozzles and fans
- 3" Brush lengths

Part #	Mfg #	Description	Price
007444	01216	3/4" Dia, 24" OAL 4" Loop, Carbon Steel	

Tool Cases

Stackable Utility Case

- Tough, durable, double-lock catch, 12" x 6" x 6"
- Lifetime guarantee

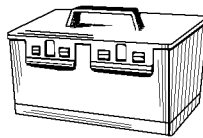

Part #	Mfg #	Description	Price
007462	75600	Tote Box - Carton	

Lock 'N Load Heavy-Duty Drybox

- Locks out moisture as well as dirt and grime
- (3) Compartments store and organize tools and accessories
- Easy access top compartment is ideal for small tools and parts
- Dimensions: 15" x 8" x 10"



Part #	Mfg #	Description	Price
061933	75605	Lock 'N Load Drybox, Carton	

Tube Cleaning Brushes

#6200 Series Power Tube Cleaning Brush

- Use for solder or brazed fittings
- Carded 1/4" hex-shank tube cleaning brushes
- Point-of-purchase display

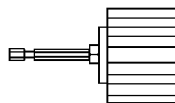

Part #	Mfg #	Description	Price
007454	62350	1/2" Bagged	
007455	62370	3/4" Bagged	

Miscellaneous Tools

Markers

Valve Action® Paint Marker

- Low chloride/low halogens paint formula
- All surface marking with durable, fade resistant, high visibility marks



Part #	Mfg #	Color	Price
057823	96801	Yellow Carded	
057825	96802	Red	
074113	96903	Black	



Miscellaneous Tools

Chemicals Insecticide

Part #	Mfg #	Description	Price
140752	85-200	Bee/Wasp Spray	

Tools

Miscellaneous Tools

Cases & Carriers

Nipple Box

- Holds 1/2" CL through 6" nipples
- Fold away handle
- Epoxy coated steel

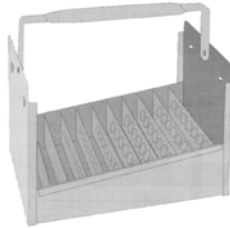

Part #	Mfg #	Size	Holds	Price
013210	3080	1/2"	77	

Miscellaneous Tools

Nipple Boxes

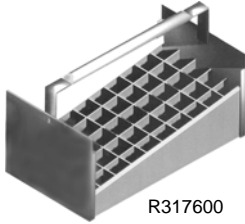

R317600

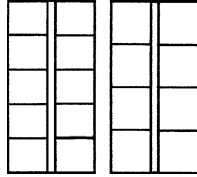

R318410

Part #	Mfg #	Description	Price
014776	R317600	E-51-R 3/4"	
094631	R318380	Ladder Mate	
080438	R318410	Galvanized Fitting Tray	

Tools

Miscellaneous Tools

Nipple Caddies

Steel Nipple Caddy Tray

- Steel construction
- Push away handles
- Baked epoxy finish
- Nipple storage range (close - 6")



Part #	Mfg #	Description	Capacity	Price
109306	N70-050	1/2" Nipple	77-Pc	
109307	N70-075	3/4" Nipple	66-Pc	
109308	N70-016	1" Nipple	50-Pc	

Internal Pipe Nipple & Screw Extractors

Internal Pipe Nipple Extractors

- Heat treated and cad plated



Part #	Mfg #	Size	Price
056472	J40-050	3/8"	
041956	J40-051	1/2"	
041957	J40-052	3/4"	

Nipple and Screw Extractor

- Left hand spiral
- Removes nipples, bolts, and screws w/o thread damage



Part #	Mfg #	Description	Price
186259	J41104	1/4" Pipe, 19/64" Drill, 3/8"-5/8" Bolt	
186926	J41106	1/2" Pipe, 17/32" Drill, 7/8"-1-1/8" Bolt	
186927	J41107	3/4" Pipe, 13/16" Drill, 1-1/8" - 1-3/8" Bolt	
186929	J41108	1" Pipe, 1-1/16" Drill, 1-3/8" - 2" Bolt	

PlumBest Handi-Plug

- Combination test plug and stub-out for drop eared elbow
- No thread seal required
- Re-usable - long lasting
- Time and labor savings
- Smooth at thread end for easy plastering



Part #	Mfg #	Description	Price
073271	H54-050	1/2" MIP Handi-Plug	

Packing

Graphite Packing

- Non-asbestos material in resealable spools



Part #	Mfg #	Description	Price
045477	T60-005	1/8" Diameter x 12' Spool	

Utility Pry Bar



Part #	Mfg #	Description	Price
041929	S49-489	13" Utility Pry Bar	

Probing Rod

Steel Probing Rod

- Welded steel construction
- Stainless steel replaceable tip



Part #	Mfg #	Description	Price
043178	P27-004	4' Steel Probing Rod	

Caulk Guns

Drop-In Half-Barrel Type Caulk Gun

- Drop-in half barrel type
- Painted steel



Part #	Mfg #	Description	Price
021059	C35-090	9" Barrel Caulk Gun	

Caulking Tools

Inside Caulking Tool

- For finishing lead joint



Part #	Mfg #	Size	Price
053532	J41-009	5/8"W x 7"L	

Outside Caulking Tool

- For finishing lead joint



Part #	Mfg #	Size	Price
053533	J41-010	5/8"W x 7"L	

Miscellaneous Tools

Caution Tape

- Black print on safety yellow
- 3 mil Thickness



Part #	Mfg #	Size	Price
041971	J43-300	3" x 300'	

Knee Pads

Heavy Duty Foam Economy Knee Pads

- Lightweight and water-resistant
- Comfortable while kneeling, standing or walking
- Won't pinch or bind behind knee
- Soft, breathable inner lining for coolness and comfort
- Velcro closures on straps



Part #	Mfg #	Description	Price
224085	K01120	1 Per Pack	

Shop Towels

Terry Towels

- Cotton Terry Cloth



Part #	Mfg #	Description	Price
224076	B05-025	(3) Pack	

Cotton Plumbers Handy Towel

- Heavy-duty shop towels
- Washable, reusable and non-abrasive



Part #	Mfg #	Description	Price
069432	B05-004	(12) Towels per Bag	

Wypall® Teri® Towel

- Strong and durable, wet or dry
- Reusable
- Equivalent to 18 lbs of rags
- Reinforced HYDROKNIT® provides extra scrubbing power

Part #	Mfg #	Description	Price
107287	B05-003	(125) Sheets per Box	

Box of Rags

- Colored cotton sweatshirt material
- 100% Recycled
- Pull-out dispensing



Part #	Mfg #	Description	Price
041975	B05-001	5 lb Box of Rags	

Heavy Duty Big Wipes

- 80 Count
- 8" x 12" wipes
- Removes paint, glue, oil, sealants, grease, and grime
- Dermatologically tested, plus Vitamin E and Aloe Vera added
- Dual sided, scrubs and cleans



Part #	Mfg #	Description	Price
186715	B05050	80 Count tub	

Trash Bags

- 2'8" x 4'2"
- 20 bags per box
- 42 gal
- 3 mil



Part #	Mfg #	Description	Price
181931	G02042	42 Gallon Trash Bags	

Marking Paints

- Inverted tip
- Water base formula
- Fast-drying and non-clogging
- Color-coded paint:
 - White for general purposes
 - Red for electric and fire protection systems
 - Blue for water and irrigation
 - Orange for telephone, telegraph and cable TV systems



Part #	Mfg #	Color	Price
043622	J40-380	White	
041973	J40-381	Yellow	
041974	J40-382	Red	
043621	J40-383	Blue	
095800	J40-385	Orange	

Miscellaneous Tools

Sponges and Brushes

Commercial Grade Cellulose Sponge

- Deeply textures
- Made in USA

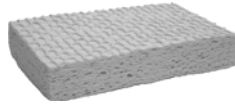

Part #	Mfg #	Description	Price
093645	S50-002	Large, 8" x 4-1/2" x 3/4"	

Show Handle Wire Brush w/ Scraper

- 4x16 rows
- Removes rust and corrosion from metals
- Oil rempered carbon steel wire tynes
- Smooth sanded hardwood block



Part #	Mfg #	Description	Price
190129	B29902	Show Handle, 4x16 rows	

Bucket Caddies



T60-102

Part #	Mfg #	Description	Price
084476	T60-102	5 Gallon Bucket, (1) Large & (4) Small Trays	
126414	T60-105	Lid for 5 Gal Bucket	
129190	T60-106	5 Gallon Bucket	
229436	T60-111	5 Gallon Bucket, (3) Large Trays	

Miscellaneous Tools

Tool Holders

Tape Measure Holder - Powerline™ Series

- Holds most tape measures with belt clips
- Rust-resistant metal clip riveted for strength
- Tunnel belt connection up to 2-1/4" belt width
- 1000 Denier DuPont Cordura® nylon
- Washable

**PowerLine™
Series**



Part #	Mfg #	Overall Size	Price
110786	5707	4-1/8" x 3-3/4"	

Zipper Canvas Bag

- Constructed of No. 8 canvas



Part #	Mfg #	Description	Price
107648	5140	Set of 4, 7" x 12-1/2", Olive, Orange, Royal Blue, and Yellow	

Tool Bags

Tool Organizer

- Constructed of double-layered 600 x 300 denier polyester
- Water-resistant
- Interior pockets include:
 - (3) Tool sleeves
 - (1) Power tool/cord sleeve
 - (6) Universal pockets
- Exterior pockets include:
 - (9) Screwdriver/nut driver pockets
 - (11) Plier pockets
 - (11) Utility pockets
 - (2) Wire stripper pockets
 - (2) Velcro® closable pockets
- Heavy-duty webbing keeps pockets open for easy access to supplies and tools
- Tools are sold separately



Part #	Mfg #	Description	Price
106843	5777	Tool Organizer 45 Pockets	

Miscellaneous Tools

Carrying Cases and Bags

Organizer Bag



Part #	Mfg #	Use with:	Price
145691	49-17-0110	Contractor Parts Organizer	

Zipper Pouch

- Rugged metal zipper
- Water resistant stand-up base
- Hang loop
- Constructed of heavy duty No. 10 canvas



Part #	Mfg #	Description	Price
170552	48-22-8180	Zipper Pouch	

3 PK Zipper Pouches

- Rugged metal zipper
- Water resistant stand-up base
- Hang loop
- Constructed of heavy duty No. 10 canvas



Part #	Mfg #	Description	Price
170554	48-22-8193	3 Pk Zipper Pouches	

Jobsite Organizer

- Mountable Bins
- Full Access When Stacked
- 20% More capacity
- Weather Seal
- No-travel bins seals



Part #	Mfg #	Description	Price
176587	48-22-8030	14"x18"x5" Tool Organizer	

Job site Backpack

- 35 Pockets for organizing tools
- Impact resistant molded base
- 1680 Ballistic material
- Load-bearing harness- padded and breathable for all day comfort
- Laptop sleeve- holds laptops up to 15.6"
- Bulk pocket- quick access to bulk items such as fish tapes and power tools
- Attachment strap- allows bag to be easily and securely attached to vertical handles



Part #	Mfg #	Description	Price
170551	48-22-8200	Job site Backpack	

Contractor Work Belt w/ Suspension Rig

- 24 Pockets for organizing tools
- 1680D Nylon construction
- Riveted seams
- All metal hardware
- Integrated carry handles
- Puncture resistant pocket
- Padded work belt- Fits 30" to 53" waists
- Smart phone pocket



Part #	Mfg #	Description	Price
170550	48-22-8120	Contractor Work Belt w/ Suspension Rig	

Electricians Work Pouch w/ Quick Adjust Belt

- 15 Pockets for organizing tools
- 1680D Nylon construction
- Riveted seams
- All metal hardware
- Integrated carry handle
- Stable base- Allows pouch to stand upright on flat surfaces
- Puncture resistant pocket
- Tape measure clip
- Belt slot- fits up to a 3" work belt
- Quick adjust belt



Part #	Mfg #	Description	Price
170548	48-22-8100	Electricians Work Pouch w/ Quick Adjust Belt	

Miscellaneous Tools

Electricians Work Belt

- 29 Pockets for organizing tools
- 1680D nylon construction
- Riveted seams
- All metal hardware
- Integrated carry handles
- Stable base- Allows pouches to stand upright on flat surfaces
- Puncture resistant pocket
- Tape measure clip
- Belt slot- Fits up to a 3" work belt



Part #	Mfg #	Description	Price
170549	48-22-8110	Electricians Work Pouch w/ Quick Adjust Belt	

M12™ Tool Holster

- Heavy duty nylon material
- Easy snap-on
- On board bit storage
- Compatible with most M12™ drilling and fastening tools



Part #	Mfg #	Description	Price
151175	2335-20	2335-20 M12 Tool Holster	

13" Job site Work Box

- Impact resistant construction
- Vertical tool storage tray
- 16" Seat height
- Cut groove
- Wide grip locking handle
- Drip ledge lid
- Indexing square
- Made in USA



Part #	Mfg #	Description	Price
170620	48-22-8010	13" Job site Work Box	

26" Job site Work Box

- Impact resistant construction
- Buttressed hinges
- Protected recessed latches
- Reinforced corners
- Integrated weather seal
- Clamping cut groove
- Over molded wide grip handle
- Pass through side grips
- Integrated screw mounting bosses
- Corner pocket storage
- Space for long and bulky tools
- Indexing square
- Made in USA



Part #	Mfg #	Description	Price
170622	48-22-8020	26" Job site Work Box	

Milwaukee® Markers

INKZALL® Black Fine Point Marker

- Clog resistant marker tip
- Writes through dusty, wet and oily surfaces
- Durable marker tip for writing on concrete, OSB and rough surfaces
- Built-In hard hat storage clip
- Fine point
- Ink dries in seconds
- Lanyard hole
- Anti-roll body design
- Non-toxic ink



Part #	Mfg #	Description	Price
165641	48-22-3100	INKZALL® Black Fine Point Marker	

1PK Med. Chisel Black Marker

- Clog resistant chisel tip marker
- Writes through dusty, wet, and oily surfaces
- Durable marker tip for writing on concrete, OSB, and rough surfaces
- Built-in hard hat storage clip



Part #	Mfg #	Description	Price
171183	48-22-3103	1Pk Med. Chisel Black Marker	

Miscellaneous Tools

2 Pack Fine Point Black

- Clog resistant marker tip
- Writes through dusty, wet, and oily surfaces
- Durable marker tip for writing on concrete, OSB, and rough surfaces
- Built-in hard hat storage clip



Part #	Mfg #	Description	Price
171184	48-22-3105	2PK Fine Point Black Markers	

INKZALL® Stylus & Black Marker

- Conductive stylus tip
- Clog resistant marker tip
- Writes through dusty, wet and oily surfaces
- Durable marker tip for writing on concrete, OSB and rough surfaces
- Built-In hard hat storage clip
- Fine point
- Ink dries in seconds
- Lanyard hole
- Anti-roll body design
- Non-toxic link



Part #	Mfg #	Description	Price
165228	48-22-3101	INKZALL® Stylus & Black Marker	

4PK Fine Point Colored Markers

- Clog resistant marker tip
- Writes through dusty, wet, and oily surfaces
- Durable marker tip for writing on concrete, OSB, and rough surfaces
- Built-in hard hat storage clip



Part #	Mfg #	Description	Price
171185	48-22-3106	4PK Fine Point Colored Markers	

Tape Measure

- Nylon bond blade protection
- 5-Point reinforced frame
- Finger stop- Protects finger during blade retraction
- Blueprint scale- Calculated 1/4" and 1/8" drawings
- Wire form belt clip- Reduces pocket tearing
- 2-Sided printing- Increases measurement readability
- Up to 9' standout
- 360 Degree hook attachment



Part #	Mfg #	Description	Price
168290	48-22-5117	16' Tape Measure	
168291	48-22-5126	25' Tape Measure	
168292	48-22-5131	30' Tape Measure	
169837	48-22-5136	35' Tape Measure	

Magnetic Tape Measure

- Nylon bond blade protection
- 5-point reinforced frame
- Finger stop- protects finger during blade retraction
- Dual magnets- prevents roll off when measuring steel studs, EMT and threaded rod
- Blueprint scales- calculates 1/4" and 1/8" drawings
- Wire form belt clip- reduces pocket tearing
- 2 Sided printing- increases measurement readability
- 360 Degree hook attachment



Part #	Mfg #	Description	Price
159975	48-22-5116	16' Magnetic Tape Measure	
159976	48-22-5125	25' Magnetic Tape Measure	

Miscellaneous Tools

Bucket Organizers

- High-impact plastic pail
- Storage trays fit snugly inside
- Easy on/off lid



Part #	Mfg #	Bucket	Trays:	Price
008175	502	5 gal	2 Large & 2 Small	

Bucket Organizer Pail Lid

- Fits both 3.5 and 5 gallon pails

Part #	Mfg #	Description	Price
059482	001	Lid Only	

Miscellaneous Tools

Tie Downs

EPDM Tie-Down Strap

- Super-strong 100% EPDM material with 2-1/2" galvanized S hooks



Part #	Mfg #	Max Length	Length	Price
183405	319-15	22"	15"	
183406	319-20	30"	20"	
183407	319-31	45"	31"	

Extendable Inspection Mirror with Angle Ball Joint

- Pocket clasp included
- Powerful long life magnetic tip



Part #	Mfg #	Size	Extension	Price
156742	390-50115	1" x 2"	5-5/8"-18-3/4"	

Pipe Cutters - Copper

Tubing Cutters

Close Quarters Tubing Cutter

- Use in restricted spaces on small diameter, hard and soft copper, aluminum, brass and plastic tubing
- Large knurled feed screw knob



Part #	Mfg #	Model	Capacity	Description	Std Wheel	Price
008659	32975	103	1/8" - 5/8"	Cutter	E-3469	
008660	32985	104	3/16" - 15/16"	Cutter	E-3469	
067702	97787	117	3/16" - 15/16"	Quick-Feed Cutter	E-3469	
051432	86127	118	1/4" - 1-1/8"	Quick-Feed Cutter	E-3469	

Constant Swing Cutter with X-CEL

- Features an enclosed feed screw to eliminate clogging and jamming, grooved rolls for close-to-flare cuts, and a fold-away reamer
- Made from high-strength aluminum alloy



Part #	Mfg #	Model	Capacity	Description	Std Wheel	Price
008687	31622	150	1/8" - 1-1/8"	Feed Cutter	E-3469	
008688	31627	150	1/8" - 1-1/8"	Feed Cutter with HD Wheel(s)	E-4546	

Tubing and Conduit Cutter with X-CEL

- Clean, square cuts on copper, brass, aluminum, and thin-wall conduit



Part #	Mfg #	Model	Capacity	Description	Std Wheel	Price
008655	32910	10	1/8" - 1"	Screw Feed Cutter	F-158	
008648	32920	15	3/16" - 1-1/8"	Screw Feed Cutter, Fold-Away Reamer	F-158	
008703	32930	20	5/8" - 2-1/8"	Screw Feed Cutter, Fold-Away Reamer	F-158	
008713	32940	30	1" - 3-1/8"	Screw Feed Cutter f/Lg Dia Steel & SS Tube	F-158	

Quick-Acting Tubing Cutter with X-CEL

- I-Beam construction, hardened wear surfaces and bearing side assemblies for smooth operation
- Plastic cutters include spare cutting wheel for cutting copper



Part #	Mfg #	Model	Capacity	Description	Std Wheel	Price
008689	31632	151	1/4" - 1-5/8"	Quick-Acting, Fold-Away Reamer	E-3469	
008690	31642	152	1/4" - 2-5/8"	Quick-Acting, Fold-Away Reamer	E-3469	
008691	31652	154	1-7/8" - 4-1/2"	Quick-Acting Tubing Cutter	E-2558	

Tools

Pipe Cutters - Copper

Internal Tubing Cutter

- For trimming tubing below floor level for shower and floor drain installations, or above the ceiling for sprinkler head installations



Part #	Mfg #	Model	Capacity Nom / Depth	Description	Std Wheel	Price
018338	33005	106	2" - 3" / 1/4" - 2-5/8"	Internal, Steel & Aluminum Body	E-2558	

Tubing Cutter Wheel



Part #	Mfg #	Model	Blade Exp	Application	For Model	Price
008575	33165	E-1240	.162	Steel - SS	10, 15, 15-SI	
008596	33175	E-2191	.292	HD Steel Tubing	30, 40, 122, 122XL, 133, 154, 156	
008599	33170	E-2558	.220	Aluminum & Copper	30, 40, 108, 109P, 133, 154, 156	
023461	34695	E-3495	.290	Aluminum	151, 152, 153, 205	
008617	33190	E-4546	.162	Steel - SS	151, 152, 153, 205	
008606	33185	E-3469	.149	Copper, Aluminum, Brass & Plastic	101,103,104,117,118,150,151,152,153,205	
008636	33160	F-158	.149	Aluminum & Copper	10,15, 20	

Tubing Cutter Parts

Part #	Mfg #	Description	For Model	Price
129719	34620	Roll Housing Screw	20	
024438	42327	Retaining Ring	101, 103, 104, 117 & 118	

Tubing Tools

456 Tri-Bender

- Ideal for plumbing and HVAC applications
- 90° Start angle minimizes effort required to form a bend
- Handy reference marks indicate the angle for quick bends through 90°



Part #	Mfg #	Model	Capacity	Price
008738	44852	456	1/4", 5/16", 3/8"	

Spring-Type Tube Bender

- Fast, free-form bending of soft copper and aluminum tube



Part #	Mfg #	Model	Length	Tube OD	Price
008563	35255	D-1377	10"	3/8"	

Tools

Pipe Cutters - Copper

Tubing Cutters

Tubing Cutters Ergonomically Designed for Professional Performance

- Professional deburring
- Will not damage cutting wheel
- Easy to use - change out wheels with only a screwdriver



Part #	Mfg #	Tube Diameter Range	Price
077287	21010-TC11/8	1/8" - 1-1/8"	
077288	21011-TC13/8	1/8" - 1-3/8"	
077289	21012-TC13/4	1/8" - 1-3/4"	
077290	21013-TC25/8	1/4" - 2-5/8"	

TSK Tight Space Tubing Cutter Kit

- Shock-resistant steel
- Non-slip grooved cast body
- 1/2" Clearance to cut
- Stainless steel rollers



Part #	Mfg #	Description	Price
140248	14833-TSK	3 Piece Tight Space Tube Cutter Kit	

Cutter Wheel



Part #	Mfg #	Description	Price
147940	14829-TSB	Copper Wheel for TS Cutter, 2-Pk	
077291	21015-TCW158 SS	Stainless Steel Cutting Wheel, 6-Pk	
089118	21017-TCW158 C	Copper Cutting Wheel, 6-Pk	
087125	21192-TCW158 C2	Copper Cutting Wheel, 2-Pk	

Tools

Pipe Cutters - Copper

Copper Tubing Cutters Close Quarters Tubing Cutter

- Most compact
- Longest life
- Chrome rollers
- Weep holes
- Directional grip
- Replaceable blade



Part #	Mfg #	Description	Price
225206	48-22-4260	1/2" Close Quarters Tubing Cutter	
225207	48-22-4261	3/4" Close Quarters Tubing Cutter	
225208	48-22-4262	1" Close Quarters Tubing	

3pc Close Quarters Tubing Cutter Set

- Most compact
- Longest life
- Chrome rollers
- Weep holes
- Directional grip
- Replaceable blade
- Includes:
 - (1) 1/2" Close quarters tubing cutter (48-22-4260)
 - (1) 3/4" Close quarters tubing cutter (48-22-4261)
 - (1) 1" Close quarters tubing cutter (48-22-4262)



Part #	Mfg #	Description	Price
225209	48-22-4263	3pc Close Quarters Tubing Cutter Set	

2pc Close Quarters Cutter Replacement Blades

- Replacement cutter wheels
- Designed for use with Milwaukee® close quarters tubing cutters
- Two pack
- High carbon steel blades
- Precision machined
- Optimized for copper



Part #	Mfg #	Description	Price
225210	48-22-4266	2pc Close Quarters Cutter Replacement Blades	

Tools



Pipe Cutters - Copper

Autocut™ Copper Tubing Cutters



ATC



RH

Part #	Mfg #	Description	Price
031428	ATC12	For 1/2" Tubing	
031429	ATC34	For 3/4" Tubing	
073599	ATC100	For 1" Tubing	
031674	RH12	Ratchet Handle for ATC12	
031675	RH34	Ratchet Handle for ATC34	
031430	ATCW	Replacement Cutter Wheels	

Pipe Cutters - Copper

Tube Benders

Tri-Tube Bender

- Indicators on handle help identify tube sizes
- Color-coded to help spot the right tube size
- Indicators on side help measure the bend radius, up to 180°



Part #	Mfg #	Description	Price
167766	1839026	1/4", 5/16", 3/8"	
171454	1839027	1/4", 3/8", 1/2"	



Pipe Cutters - PEX

Tubing Cutters ProPEX®/Tubing Cutter

- Replaceable blades
- Double ground steel V-shaped blade
- Metal core - indestructible frame
- Rework groove
- One-handed locking mechanism
- Rust protection



Part #	Mfg #	Description	Price
143343	48224200	Cuts up to 1" Tubing	

ProPEX®/Tubing Cutter Replacement Blade

- Double-Ground V-Shaped Blade (Patent Pending)
- Cleaner Cuts on 1" rubber and plastic tubing/PEX-a tubing
- Rust protection - stainless design for increased tool life and corrosion resistance



Fits 48-22-4200 and 48-22-4202 Milwaukee® Tubing Cutters

Part #	Mfg #	Description	Price
170838	48224203	Replacement Blade	

Pipe Cutters - Plastic

Plastic Tubing Cutters Quick-Acting CSST Cutter

- I-Beam frame
- Cuts corrugated gas tubing 3/8" - 1"
- Two sets of split-floating guide wheels
- Ergonomic knob
- Full lifetime warranty



Part #	Mfg #	Model	Capacity	Description	Std Wheel	Price
122158	32078	151 CSST	3/8" - 1"	Quick-Acting CSST Cutter	33190	

Plastic Pipe Tubing Cutter

- Designed for quick, clean cuts through plastic pipe and tube



Part #	Mfg #	Model	Capacity	Description	Std Wheel	Price
104549	23493	PC-1375	1/8" - 1"	Single Stroke Plastic Pipe & Tubing Cutter	X-CEL™ PCB-1375	
108391	23498	RC-1625	1/2" - 1-5/8"	Ratchet Action Plastic Pipe & Tubing Cutter, Erg Grip	27858	
119754	30088	RC-2375	1/2" - 2-3/8"	Ratchet Action Plastic Pipe & Tubing Cutter, Erg Grip	30093	

P-TEC 2550 Tailpiece Extension Cutter

- For thin-wall plastic tube
- Undercounter specialty tool for polyethylene, polypropylene and thin-walled PVC disposer kits, tailpieces and wall tube
- Clean automatic deburring
- Automatic beveling



Part #	Mfg #	Model	Description	Price
132413	34943	P-TEC 2550	Tailpiece Extension Cutter	

Cutter Replacement Blade

Part #	Mfg #	Model	Description	Price
008706	22086	1493	Replacement Blade with Clip	
104550	25588	PCB-1375	X-CEL™ Replacement Blade	
132081	27858	RCB-1625	Replacement Blade for RC-1625	
123436	30093	RCB-2375	Replacement Blade for RC-2375	
008565	92170	138	Replacement Blade for 91125	

Plastic Tubing Cutter Wheel



Part #	Mfg #	Model	Blade Exp	Application	For Model	Price
008626	33195	E-5272	.290	PVC, ABS, Standard Wall	151-P, 152-P	
008627	33180	E-5299	.412	PVC, ABS, Standard Wall	30P - 133P, 106, 108, 109P, 154-P, 156-P	

Tools

Pipe Cutters - Plastic

Big Nipper™

- Cuts hose and tubing up to 2-1/2" ID, polyethylene up to 1-1/2" ID, and PVC up to 1-1/2" ID
- Excellent for cutting tubing insulation
- Replaceable stainless steel blade
- Clean cut - no burrs or sawdust replaceable blades



Part #	Mfg #	Description	Price
112016	16368	Big Nipper Cutter	

Li'l Nipper™

- Cuts up to 1-1/4" polyethylene, PVC, ABS, and rubber hose
- Cutters are light and can be handily carried in back pocket or tool pouch
- Strong nylon handle with replaceable blades
- Cutters do not distort pipe



Part #	Mfg #	Description	Price
002266	0125	Li'l Nipper™ Cutter	
026128	0127	2 Replacement Blades	

Pipe Cutters - Plastic

PVC Cutters

PVC Cutter

- Makes clean burr-free cuts
- Reversible blade
- Handle latch keeps tool closed



Part #	Mfg #	PVC Capacity	Flex Pipe Capacity	Price
125142	50506	3/4" Sch 40	1-3/8"	

PVC Cutter Replacement Blade



Part #	Mfg #	Description	Price
141615	50549	Blade for 50506	

Pipe Cutters - Plastic

Pipe/Tubing Cutters

Professional PVC Pipe Cutter

- Rustproof
- Non-electro nickel-plated blade
- Locking hook can be used to debur pipe
- Carded



Part #	Mfg #	Description	Price
054586	P70-018	1-1/4" PVC Pipe Cutter	

PVC Pipe Cutter

- High carbon steel blades
- Aluminum alloy handles
- Ratchet action



Part #	Mfg #	Description	Price
040773	P70-001	1" Pipe Cutter	
071043	P70-002	2" Pipe Cutter, Heavy-Duty	

PlumBest E-Z Shear Inside Pipe Cutter

- Cuts PVC and ABS pipe
- High speed steel blade with zinc-plated shaft



Part #	Mfg #	Description	Price
026324	J40-830	E-Z Shear Pipe Cutter	
026325	J40-831	(2) Replacement Blades	

Socket Saver

- Removes Sch 40 plastic pipe from plastic fittings
- Cuts ABS or PVC DWV pipe below slab
- Fits 1/2" variable speed power drill



Part #	Mfg #	Description	Price
082721	J44-075	3/4" Ram Bit Cutter	
054591	J44-150	1-1/2" Socket Saver	
054592	J44-200	2" Socket Saver	
054593	J44-300	3" Socket Saver	
054594	J44-400	4" Socket Saver	

Pipe Cutters - Plastic

Tube and Pipe Cutters

Inside Pipe Cutter

- Steel blade for plastic pipe
- Abrasive disc for plastic or steel pipe



390-50163

Part #	Mfg #	Steel Blade Size	Price
035402	390-50163	1-1/4"	
035403	390-50164	1-1/4" Hardened	

PowerPEX Crimp Tools (Complete Line of ASTM F1807 Options)

- Complete line of F1807 crimp tool options below:
- Steel or composite handles
- Composite handles are strong and durable, yet lightweight
- Compact tools allow one-hand crimping
- Combo tool for the most common crimp connections and added cost savings
- Free Go/No-Go gauge provided with every model
- Also work on PB 1380 tube and fittings



305-23CPK

Composite Handle

Part #	Mfg #	Description	Length	Price
183403	305-23CPK	1/2" Over-3/4" Combo	14"	

Plactic Tube and Hose Cutter

- Quickly cut PEX, PVC, CPVC and other poly pipe or non-metallic hose
- For 1 1/8" O.D. tube or smaller



304-08

Part #	Mfg #	Blade Length	Price
160228	304-08	2-1/4"	

Pipe Cutters - Copper

Plastic Tubing Cutters

S1 Plastic Tubing Cutter

- *Serrated stainless steel blade requires less force to make a cut*
- *Rubberized handles*
- *Easy open and close*
- *Conveniently positioned locking latch allows for one-handed operation of spring-loaded cutter*



Part #	Mfg #	Description	Price
121471	12121S1	1" Nom - 1-5/16" Max OD	
121472	12125S1B	S1 Replacement Blade	

Plastic Tubing Cutter Wheel



Part #	Mfg #	Description	Price
081771	21016-TCW158 P	Plastic Cutting Wheel, 6-Pk	

Tools

Pipe Cutters - Soil Pipe

Soil Pipe Cutters

- Provides 1-stroke cutting of 1-1/2" to 6" service weight, No-Hub® soil pipe, clay, asbestos and cement pipe



Part #	Mfg #	Model	Pipe Capacity	Description	Price
008709	32900	246	1-1/2" - 6"	Cuts Clay, Cast Iron, Cement Pipe, 4" Class 22 Water Main	

Pipe Cutters - Steel

Pipe Cutters

Heavy-Duty Pipe Cutter

- Fast, clean pipe cutting by hand or power
- Extra-long shank protects adjustment threads, while an extra-large handle is provided for quick, easy adjustment
- Can be converted to 3-wheel cutter by replacing rollers with cutter wheel



Part #	Mfg #	Model	Pipe Capacity	Description	Price
008701	32820	2-A	1/8" - 2"	Heavy-Duty Pipe Cutter	

Pipe Cutter Replacement Wheel



Part #	Mfg #	Model	Blade Exp	Application	For Model	Price
008732	44185	E-1032	.450	Steel & Ductile Iron	202, 360, 732, 820/364	
008641	33105	F-3	.312	Steel & Ductile Iron	1A, 2A, 42A, 202, 360, 732, 820/364	
008637	33125	F-229	.411	Steel & Ductile Iron	3S, 4S, 44S, 466C/S/HWS, 468C/S/HWS, 472C/S/HWS, 764	
008643	33100	F-514	.312	Steel & Ductile Iron	1A, 2A, 42A, 202, 360, 732, 820/364	

Pipe Cutter Parts

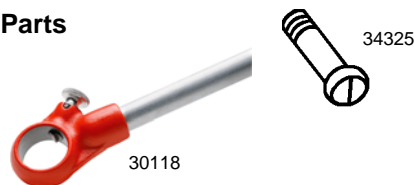

Part #	Mfg #	Model	Description	For Model	Price
008664	30118	E-3055X	Ratchet with Handle	12-R	
008720	32142		Wheel Pins with Clip, 5/Pk	151-P, 152, 152-P, 152-PVC, 153, 153-P	
008574	33970	E-1189X	Rings with Pin, 5/Pk	101, 103, 104	
008590	34325	E-1948	Screws, 10/Pk	10, 15, 15-SI	
008638	34805	F-255	Roller, 5/Pk	15	
129720	34825	F-266	Roller, 5/Pk	20	

Tools

Pipe Cutters - Plastic

Pipe Cutters Inside Pipe Cutter

- Cuts 2" and larger plastic pipe
- Fits electric drill

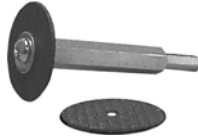

Part #	Mfg #	Description	Price
053717	P70-029	(3) Replacement Blades	

Pipe Taps

Machine Screw Tap - Plug Style



Part #	Mfg #	Description	Price
141468	R305100	WC10 1/4-20 N.C.	

Tools

Pipe Taps

Pipe Taps

Pipe Tap



Part #	Mfg #	Size	Price
056686	T41-001	1/8"	
056687	T41-002	1/4"	
041961	T41-004	1/2"	
041962	T41-005	3/4"	
050029	T41-006	1"	
056690	T41-008	2"	

Pipe Threaders

Pipe Tools Pipe Reamer

- All reamers include handles



Part #	Mfg #	Model	Capacity	Description	Price
008702	34955	2-S	1/4" - 2"	Spiral Ratchet	

Inner-Outer Reamer

- Plastic construction with long-wearing alloy steel blades



Part #	Mfg #	Model	Description	Construction	Price
017583	34965	127	1/4" - 1-1/2" Nominal Water Tube	Plastic	

Hardened Steel Inner-Outer Reamer

- Hardened steel construction
- 46 Cutting edges on interior cone
- For fast, clean, inner reaming and outer deburring/beveling of 1/2"-2" copper and stainless steel tubing



Part #	Mfg #	Model	Description	Construction	Price
111700	29993	227S	1/2" - 2" Copper & SS Tubing	Hardened Steel	

Deburring Tool

- For plastic pipe and tubing
- Made of high-grade steel with long-lasting cutting edges
- Ideal for removing outside ridges and inside burrs on plastic pipe and tubing



Part #	Mfg #	Model	Capacity	Plastic Cap ID	Price
033796	64967	74	4"	--	

Individual Pipe Extractor

- Easily removes broken threaded ends of pipe, pipe plugs and fittings
- Each is plainly marked showing drill size used when solid ends of plugs and fittings must be drilled to receive extractor



Part #	Mfg #	Model	Pipe Size	Length Overall	Use Drill	Price
120553	35610	83	1/2"	3"	5/8"	

Tools

Pipe Threaders

Manual Threaders Manual Threader Die Head

• North American standards



Part #	Mfg #	Model	Description	Nominal Pipe Capacity	Price
008661	37040	11-R	Alloy RH	1/2"	
008672	37390	12-R	Alloy RH	1/2"	
008679	37395	12-R	Alloy RH	3/4"	
008666	37400	12-R	Alloy RH	1"	
008670	37405	12-R	Alloy RH	1-1/4"	
008668	37410	12-R	Alloy RH	1-1/2"	
008677	37415	12-R	Alloy RH	2"	

Pipe Die - National Pipe Taper NPT



Part #	Mfg #	Model	Description	Nominal Pipe Capacity	Price
008671	37825	12-R	Alloy RH	1/2" - 14	
008678	37830	12-R	Alloy RH	3/4" - 14	
008665	37835	12-R	Alloy RH	1" - 11-1/2	
008669	37840	12-R	Alloy RH	1-1/4" - 11-1/2	
008667	37845	12-R	Alloy RH	1-1/2" - 11-1/2	
008676	37850	12-R	Alloy RH	2" - 11-1/2	
008724	37920	12-R	High Speed SS RH	3/4" - 14	
008725	37925	12-R	High Speed SS RH	1" - 11-1/2	

Power Threading Equipment

Oil-Less Threading Machine Parts and Accessories

Part #	Mfg #	Model	Description	Price
032337	67822	120	Folding Stand	

Pipe Die for Machine Die Heads



Pipe Die for 504A, 711, 731, 811A, 815A and 842

Part #	Mfg #	Die Material or Type	(NPT) Nominal Pipe Size Threads Per Inch	Price
008747	47745	Alloy RH NPT	1/2"-3/4" - 14	
008748	47750	Alloy RH NPT	1"-2" - 11-1/2	

Tools



Pipe Threaders

Golden Tool™ Pipe Threaders Golden Pipe Shredder™ Kit

- 4 Shredder tools: 1-1/2", 2", 3", 4"
- 1/2" Arbor size



Part #	Mfg #	Size	Qty	Price
143396	98040	1-1/2"	4	
143394	98041	2"	4	

Tools

Pliers & Wire Strippers

Pliers

6-in-1 Long Nose Pliers

- Integrated reaming head to smooth-out rough edges of metal pipe
- High-leverage design
- (6) Applications:
 - Reaming
 - Wire stripping
 - Nail/wire cutting
 - Nail pulling
 - Pliers
 - Loop maker



Part #	Mfg #	Description	Price
150218	48-22-3068	Long Nose Pliers	

6-in-1 Combination Pliers

- Integrated reaming head to smooth-out rough edges of metal pipe
- High-leverage design
- (6) Applications:
 - Reaming
 - Wire stripping
 - Bolt cutter
 - Wire cutting
 - Pliers
 - Loop maker



Part #	Mfg #	Description	Price
149136	48-22-3069	Combination Pliers	

Tongue & Groove Pliers

- Reaming head design to smooth out rough edges of up to 2" pipe
- Forged alloy steel for maximum tool strength
- Induction hardened jaws
- Smooth transition grips minimize wear tear and improve punchability
- Rust protection increases tool life by reducing corrosion



Part #	Mfg #	Size	Price
143342	48-22-3210	10"	
150217	48-22-3212	12"	

10" Quick Adjust Reaming Pliers

- Exposed reaming handles - up to 1" conduit (Patent Pending)
- Reaming head design- smooths out rough edges of up to 2" pipe (Patent Pending)
- Quick adjust jaws- V-groove jaws create a more precise fit with up to 2" jaw capacity
- Forged alloy steel- for maximum tool strength
- Rust protection- increases tool life by reducing corrosion
- Smooth transition grips- minimize wear tear and improve punchability



Part #	Mfg #	Description	Price
162647	48-22-3110	10"	

Hex-Jaw Pliers

- Hex-Jaw design- best fit for hex bolts (patent pending)
- All-metal quick adjust mechanism- 26 positions for precise fit
- REAM & PUNCH™ Handles (patent pending)- Deburr smooth pipe up to 2 3/4" and punch electrical knock outs
- Jaw capacity - up to 2 3/4" hex bolt hardened teeth - long gripping life
- Slim head design comfort grips - will not peel from jobsite conditions
- Rust resistant
- Forged design for added strength



Part #	Mfg #	Description	Price
175107	48-22-6212	12" Hex - Jaws Pliers	

TORQUE LOCK™ Curved Jaw Locking Pliers with Durable Grip

- TORQUE LOCK™ Faster setup and easy release
- Curved Jaw: Maximizes pressure points for any bolt, nut or locking tool application
- Hardened Jaws: Better grip force on job site material
- Rust Protection: Increases tool life by reducing corrosion
- Overmold Grips: Durable and comfortable



Part #	Mfg #	Description	Price
168835	48-22-3405	5" TORQUE LOCK™ Curved jaw locking pliers	
168834	48-22-3407	7" TORQUE LOCK™ Curved jaw locking pliers	

Pliers & Wire Strippers

Pliers (Continued)

TORQUE LOCK™ Curved Jaw Locking Pliers with Durable Grip

Part #	Mfg #	Description	Price
168827	48-22-3410	10" TORQUE LOCK™ Curved jaw locking pliers	

TORQUE LOCK™ Long Nose Locking Pliers With Durable Grip

- TORQUE LOCK™ Faster setup and easy release
- Curved Jaw: Maximizes pressure points for any bolt, nut or locking tool application
- Hardened Jaws: Better grip force on job site material
- Rust Protection: Increases tool life by reducing corrosion
- Overmold Grips: Durable and comfortable



Part #	Mfg #	Description	Price
168837	48-22-3409	9" TORQUE LOCK™ Long Nose Locking Pliers with Durable Grip	
168838	48-22-3406	6" TORQUE LOCK™ Long Nose Locking Pliers with Durable Grip	

TORQUE LOCK™ Straight Jaw Locking Pliers

- TORQUE LOCK™: Faster setup and easy release
- Straight Jaw: Maximizes contact points on job site work surfaces
- Hardened Jaws: Better grip force on job site material
- Forged Alloy Steel: For maximum tool strength and durability
- Rust Protection: Increases tool life by reducing corrosion



Part #	Mfg #	Description	Price
168826	48-22-3507	7" TORQUE LOCK™ Straight Jaw Locking Pliers	
168825	48-22-3510	10" TORQUE LOCK™ Straight Jaw Locking Pliers	

TORQUE LOCK™ Curved Jaw Locking Pliers

- TORQUE LOCK™: Faster setup and easy release
- Curved Jaw: Maximizes pressure points for any bolt, nut or locking tool application
- Hardened Jaws: Better grip force on job site material
- Forged Alloy Steel: For maximum tool strength and durability
- Rust Protection: Increases tool life by reducing corrosion



Part #	Mfg #	Description	Price
168824	48-22-3420	10" TORQUE LOCK™ Curved Jaw Locking Pliers	

6-in-1 Lineman's Pliers

- Integrated reaming head to smooth-out rough edges of metal pipe
- High-leverage design
- (6) Applications:
 - Reaming
 - Bolt cutter
 - Wire cutter
 - Nail pulling
 - Pliers
 - Fish tape puller



Part #	Mfg #	Description	Price
149137	48-22-3309	9" Lineman's Pliers	

7" 6 IN 1 Diagonal Pliers

- Reaming head design- smooth edges of metal pipe from 1/2" to 1" (Patent Pending)
- Bolt cutter - thread and cut #6 and #8 bolts to preferred length (Patent Pending)
- High leverage design
- Laser hardened cutting edges
- Offset head design - 15 degree offset head for easier and quicker prying and pulling (Patent Pending)
- Rust protection



Part #	Mfg #	Description	Price
175105	48-22-6107	7" 6 IN 1 Diagonal Pliers	

Pliers & Wire Strippers

Pliers

Water Pump Pliers

- *Hardened and tempered for durability*



Part #	Mfg #	Model	Description	Length	Price
008764	80475	734	2" Capacity	10"	

Pliers & Wire Strippers

Milled Jaw Slip-Joint Pliers

- Nickel-plated finish with plastic grips
- Angle-nose pliers have grip tight clip



306-10

Part #	Mfg #	Type	Size	Max Opening	Price
113964	306-10	10"	Angle Nose	1-1/2"	

Pliers & Wire Strippers

Pliers

- Undercut tongue and groove design won't slip
- Patented reinforcing edge minimizes stress breakage
- CHANNELLOCK BLUE® grips for comfort

Smooth Jaw Tongue & Groove Pliers

- Smooth jaws for non-marring surfaces (PVC pipe, chromes, etc)
- Smooth jaw for use on plated fixtures
- PermaLock® fastener eliminates nut and bolt failure



Part #	Mfg #	Length	Capacity	Price
026715	R116800	10"	2"	

Straight Jaw Tongue & Groove Pliers

- High-carbon C1080 steel for superior performance on the job and electronic coating for ultimate rust prevention
- Right-angle, laser-heat treated teeth grip better and last longer
- PermaLock® fastener eliminates nut and bolt failure



R117200



R117400



R117600



R117800



R117900

Part #	Mfg #	Length	Capacity	Price
076358	R117200	6-1/2"	7/8"	
008905	R117400	9-1/2"	1-1/2"	
008907	R117600	10"	2"	
008908	R117800	12"	2-1/4"	
109928	R117900	16-1/2"	4-1/4"	

V-Jaw Tongue & Groove Pliers

- High-carbon C1080 steel for superior performance on the job and electronic coating for ultimate rust prevention
- Right-angle, laser heat-treated teeth grip better and last longer
- V-Jaws give you more points of contact on round stock and tubing
- PermaLock® fastener eliminates nut and bolt failure



R118300



R118400

Part #	Mfg #	Length	Capacity	Price
008906	R118300	9-1/2"	1-1/2"	
139950	R118400	10"	2"	

Pliers & Wire Strippers

Standard Side-Cutting Pliers

NE-Type Side-Cutting Pliers

- Plastic dipped handles
- Sure-gripping, cross-hatched knurled jaws



Part #	Mfg #	Overall Length	Jaw Length	Jaw Width	Price
106804	D201-7NE	7-7/16"	1-9/32"	1-1/16"	

High Leverage Side-Cutting Pliers

NE-Type Side-Cutting Pliers - Streamlined Design

- Plastic dipped handles
- Streamlined design with sure-gripping, cross-hatched knurled jaws
- High leverage



Part #	Mfg #	Overall Length	Jaw Length	Jaw Width	Price
106803	D213-9NE	9-1/4"	1-19/32"	1-1/4"	

High Leverage Diagonal-Cutting Pliers

Diagonal Cutter Pliers

- Plastic dipped handles
- High leverage



Part #	Mfg #	Overall Length	Jaw Length	Jaw Width	Price
106806	D228-7	7-1/8"	13/16"	1-3/16"	

Diagonal Angled Head Cutter Pliers

- Plastic dipped handles
- High leverage



Part #	Mfg #	Overall Length	Jaw Length	Jaw Width	Price
106805	D248-8 *	8-1/16"	13/16"	1-3/16"	

* Semi-flush cuts Cherry Barrel rivets - for use on non-ferrous wire only

Journeyman™ Diagonal Angled Head Cutter Pliers

- Dual material handles
- High leverage

JOURNEYMAN



Part #	Mfg #	Overall Length	Jaw Length	Jaw Width	Price
112637	J248-8	8-1/8"	13/16"	1-3/16"	

Needle-Nose Pliers

Standard Long-Nose Side-Cutting Pliers

- Plastic dipped handles
- Induction hardened, long-lasting cutting knives
- Knurled jaws for sure wrapping and looping



Part #	Mfg #	Overall Length	Jaw Length	Jaw Width	Price
106807	D203-6	6-5/8"	1-7/8"	11/16"	

Heavy-Duty Side-Cutting Long-Nose Pliers - Wire Stripping & Crimping

- Plastic dipped extended handles
- Cleanly strips 12 AWG wire
- Crimps connectors, lugs, and terminals
- Induction hardened cutting knives



Part #	Mfg #	Overall Length	Jaw Length	Jaw Width	Price
106808	D203-8NCR	8-5/8"	2-5/16"	1"	

Slip-Joint Pliers

Slip-Joint Pliers - Plastic Dipped Handles

- (2) Versatile jaw positions
- Serrated jaws
- Nickel-chrome plated



Part #	Mfg #	Overall Length	Jaw Length	Jaw Width	Price
112647	D511-6	6-1/2"	1-3/16"	1-3/16"	

Pump Pliers

Pump Pliers - Plastic Dipped Handles

- Secure tongue and groove design for non-slip grip
- Wide range of versatile jaw positions



Part #	Mfg #	Length	Max	Price
111629	D502-6	6-1/2"	7/8"	
106809	D502-10	10"	1-3/4"	
106810	D502-12	12-1/4"	2-3/8"	

Pliers & Wire Strippers

Wire Stripping & Cutting Tools

TripSaver® Combination Multi-Tool

- High-carbon, rust-resistant stainless steel
- Lightweight, compact, sturdy
- Locking "L" handle snaps into "L" channel
- Includes:
 - Needle-nose pliers
 - Beveled wire cutter
 - Toothed pipe grippers
 - Files (coarse and fine)
 - 5-Slot wire stripper (10-18 AWG)
 - Wire-looping hole
 - Scraper
 - Awl/reamer
 - Serrated sheepsfoot knife
 - Clip-point knife
 - Standard/metric ruler
 - Drywall saw
 - Locking "L" handle
 - #1 and #2 Phillips hex bits
 - (1) Small- and (2) large-slotted hex bits
 - 1/4" Socket adapter
 - Lanyard hole and nylon pouch



Part #	Mfg #	Description	Price
111226	1016	5-3/4" Long, TripSaver Multi-Tool	

Long-Nose Multi-Purpose Tool

- Crimps insulated and non-insulated terminals and 7 to 8mm ignition terminals
- Long, curved cutting blade
- Cleanly shears bolts
- Plastic covered cushioned handles



Part #	Mfg #	Strips & Cuts	Price
107642	1010	10 - 22 AWG	

Klein-Kurve™ Wire Stripper/Cutter

- Precision shear-type blades
- Clean cuts on solid and stranded copper wire
- Markings on both sides
- Curved handles
- Wire looping and bending holes
- Coil spring provides fast self-opening action
- Precision-ground stripping holes
- Strong-gripping serrated nose
- Screw-shearing holes
- Handy closure lock for convenient storage
- Double dipped comfort grips



Part #	Mfg #	Strips & Cuts	Price
106811	11055	10-18 Solid, 12-20 Stranded	

Pliers & Wire Strippers

Pliers

Tongue and Groove Pliers

- Right angle teeth
- Comfort grips
- Undercut tongue and groove - won't slip



CHAN NEL LOCK

Part #	Mfg #	Description	Price
187740	J40-401	6-1/2" Long, 7/8" Capacity	
187741	J40-402	9-1/2" Long, 1-1/2" Capacity	
041942	J40-403	10" Long, 2" Capacity	
041943	J40-404	12" Long, 2-1/4" Capacity	

Tongue and Groove Pliers with Smooth Jaw

- Smooth jaws for non-marring surfaces (PVC, chromes, etc)
- Undercut tongue and groove
Comfort grips



Part #	Mfg #	Description	Price
187742	J40-406	10" Channel Lock. 2" Capacity	

Pliers & Wire Strippers

Wire Strippers

7" Wire Stripper

- *Comfortable grip*
- *Quick ID with easy-to-read size markings*



Part #	Mfg #	Description	Price
174618	1885426	7" Wire Strippers	

Pliers

Quick-Adjusting Tongue & Groove Pliers

- *Comfortable grip*
- *Push button allows for quick adjustments while multiple grooves guarantee precise positioning*
- *Machined jaws increase grip on the material*



Part #	Mfg #	Description	Price
174615	1890996	8" Pliers	
174616	1890997	10" Pliers	



Power Sewer Machines

Ken-Way Junior Drain Cleaner

- Cleans 1" to 4" drain and process lines
- All steel construction
- Can handle cable sizes 1/4" to 1/2"
- Three drum size options
- Chuckless design speeds cable feeding
- Air powered foot switch
- Heavy-duty 1/4 hp motor
- Dimensions: 14"H x 17-1/2"W x 11"D
- Weight without cable: 24 lbs



Part #	Mfg #	Description	Price
110571	J045	Ken-Way Jr. Drain Cleaner w/Regular Drum & 3/8" x 50' Blade End Cable & Blades	



Power Sewer Machines

Super-Vee™ Drain Cleaners

Super-Vee™ Drain Cleaner Kit

- Includes:
 - Basic unit (side action chuck, variable speed motor with reversing switch)
 - Case
 - HECS Cutter set
 - (1) Additional cartridge

Part #	Mfg #	Description	Price
019540	SV-C-WC	1/4" x 50' (50HE1) & 3/8" x 35' (35HE2) Cables	

Mini-Router™ Drain Cleaners

Mini-Router™ Drain Cleaner Kit

- Includes:
 - Basic unit (MR-200 drum, 1/3 hp motor with reverse switch, 10' power cord, ground fault interrupter, waterproof air foot switch, leather gloves and cable)
 - MRCS Cutter set (AH arrow head, BG boring gimlet, 1-1/2" U & 1-1/2" U-cutter, 2" SCB side cutter blade)

Part #	Mfg #	Description	Price
005054	MR-B	75' x 3/8" (75EM2) Cable & MRCS Cutter Set	

Mini-Router™ Drainer Cleaner Accessories



Part #	Mfg #	Description	Price
028942	MR-W	Mini-Router™ Dolly	

Flexicore Cables

- With male and female connectors

Part #	Mfg #	Size	Price
005072	50EM2	3/8" x 50'	
027735	100EM5	3/4" x 100'	

Replacement Cables



Basin Plug Head

Part #	Mfg #	Description	Price
020328	25HE1	1/4" x 25' w/El Basin Plug Head	
005073	50HE1	1/4" x 50' w/El Basin Plug Head	

Cutters

Cutters for 3/8" Cable

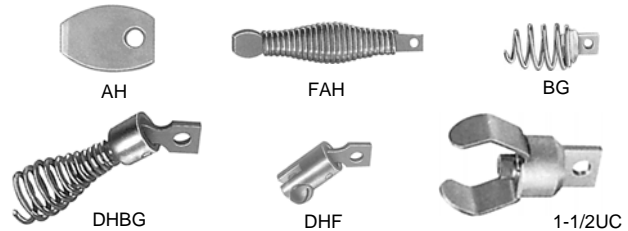

Part #	Mfg #	Description	Price
005048	AH	Arrow Head	
018911	FAH	Flex Arrow Head	
005049	BG	Boring Gimlet	
005051	DHBG	Down Head Boring Gimlet	
005052	DHF	Down Head Fitting	
005065	1-1/2UC	1-1/2" U-Cutter	

Cutters for 5/8" & 3/4" Cable

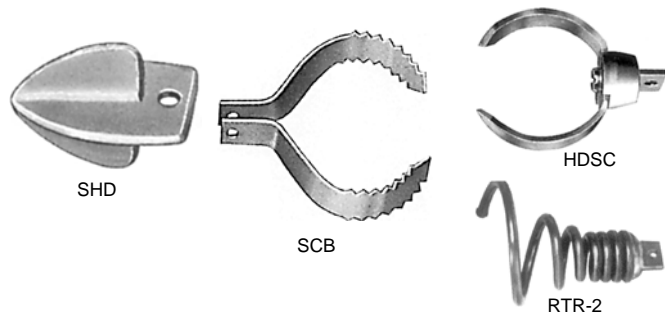

Part #	Mfg #	Description	Price
019877	SHD	Spear Head Starting Drill	
005069	3SCB	3" Side Cutter Blade - 2-Pc	
005071	4SCB	4" Side Cutter Blade - 2-Pc	
017789	3HDSC	3" Heavy-Duty Side Cutter	
019876	RTR-2	Corkscrew Retrieving Tool	

Connectors

Basic Connector

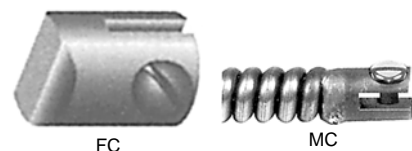

Part #	Mfg #	Description	Price
019868	5/8FC	5/8" Female, Butt Weld	
019870	3/4FC	3/4" Female, Butt Weld	
005070	3/8E-FC	3/8" Female, For 3/8" EM Cable	
019865	3/8MC	3/8" Male	



Power Sewer Machines

Connectors (Continued)

Basic Connector

Part #	Mfg #	Description	Price
019867	1/2MC	1/2" Male	
019869	5/8MC	5/8" Male, Butt Weld	
019975	3/4MC	3/4" Male, Butt Weld	

Quick Fix Connector



Part #	Mfg #	Description	Price
019860	1/2QF	1/2" Quick Fix	
019862	5/8QF	5/8" Quick Fix	
017788	3/4QF	3/4" Quick Fix	

Connector Screw

Part #	Mfg #	Description	Price
019864	5/8CS	5/8", 5-Pack, For Butt Weld	
005050	3/4CS	3/4", 5-Pack, For Butt Weld	

D-25 Handy™ Drain Cleaner Heads

D-25 Handy™ Drain Cleaner Head - Down Head (DH)

- Flexicore™ cable units
- Can be attached to a drill



Part #	Mfg #	Description	Price
095198	D-25-2	1/4" x 25'	

No. 25 Handy Drain Cleaner Heads

Down Head (DH) Handy



Part #	Mfg #	Description	Price
092130	25-8	5/16" x 25'	

Flexicore® Wire Rope Center Drain Augers

Regular Head less Handle

- Includes rotary handle
- Hand wire only



Part #	Mfg #	Description	Price
043667	L-25FL1	1/4" x 25'	

Down Head less Handle

- Includes rotary handle
- Hand wire only



Part #	Mfg #	Description	Price
097172	L-25FL1-DH	1/4" x 25'	

Flat Sewer Rods

- Oil tempered - rust ban coated
- Quick-Grip handle
- Roller head



Flat Sewer Rod for 4" - 6" Pipe

Part #	Mfg #	Size	Lgth	Price
032705	100D	3/4" x 1/8"	100'	

Power Tools

M12™ Lithium-Ion Cordless Tools

M12™ Cordless 3/8" Right Angle Drill Driver Kit

- No load speed: 0 to 800 rpm
- Clutch settings: 11+ Drill
- Chuck type: 3/8" single sleeve
- Head length/weight: 3-3/4"/2.4 lbs
- Includes:
 - M12™ 3/8" Right angle drill driver
 - M12™ Lithium-Ion battery
 - 30-Minute charger
 - Soft carrying case
- 5-Year warranty



Part #	Mfg #	Description	Price
160481	2415-20	M12™ Cordless 3/8" Right Angle Drill/Driver (Bare Tool)	
137547	2415-21	Drill Driver Kit, Cordless 3/8" Right Angle 100in-lbs Torque	

M12™ Cordless 3/8" Drill Driver

- All metal locking chuck
- 2-Speed all metal gear box
- No load speed: 0 to 400/0 to 1,500 rpm
- Clutch settings: 11+ drill
- Chuck type: 3/8" single sleeve
- Torque: 275 in-lbs
- Kit includes:
 - M12™ Drill driver (2410-20)
 - (2) 12V Lithium-Ion batteries
 - 30-Minute charger
 - Soft carrying case
- 5-Year warranty



Part #	Mfg #	Description	Price
137548	2410-22	Drill Driver Kit	

M12™ Cordless 3/8" Hammer Drill Driver

- 7-5/8" Length, 2.8 lbs
- 2-Speed metal gear box: 0 to 400/0 to 1,500 rpm
- 3/8" Metal single sleeve ratcheting chuck
- On-board fuel gauge
- Built-in LED light
- Torque: 275 in-lbs
- Kit includes:
 - M12™ 3/8" Hammer drill driver (2411-20)
 - (2) M12™ REDLITHIUM™ Batteries
 - 30-Minute charger
 - Carrying case



Part #	Mfg #	Description	Price
137549	2411-22	Hammer Drill Driver Kit	

M12™ 3/8" Hammer Drill/Driver Kit

- Delivers up to 275 in lbs of Torque
- On-board battery fuel gauge displays remaining run time
- New ergonomic handle design for increased comfort
- Metal ratcheting chuck for maximum durability
- Includes:
 - (1) M12™ 3/8" Hammer drill/driver (Bare Tool) (2408-20)
 - (2) M12™ REDLITHIUM™ battery (48-11-2401)
 - (1) M12™ Lithium-ion battery charger (48-59-2401)
 - (1) Belt clip
 - (1) Carrying case



Part #	Mfg #	Description	Price
162002	2408-20	M12™ 3/8" Hammer Drill/Driver (Bare Tool)	
161649	2408-22	M12™ 3/8" Hammer Drill/Driver Kit	

Power Tools

M12 FUEL™ 1/2" Drill/Driver Kit

- **POWERSTATE™ Brushless motor:** Delivers up to 350 in-lbs of peak torque with maximum sustained torque to complete a variety of applications
- **REDLITHIUM™ Battery technology:** Superior pack construction, electronics, and performance deliver more work per charge and more work over pack life than any battery on the market
- **REDLINK Plus™ Intelligence:** The most advanced system of cordless power tool electronics. Provides optimized performance and overload protection using total system communication between tool, battery and charger
- **Includes:**
 - (1) M12 FUEL™ 1/2" Drill/Driver (bare tool) (2403-20)
 - (1) M12 REDLITHIUM™ 2.0 Compact battery pack (48-11-2420)
 - (1) M12™ REDLITHIUM™ XC 4.0 Extended capacity battery pack (48-11-2440)
 - (1) M12™ Lithium-ion battery charger (48-59-2401)
 - (1) Belt clip
 - (1) Carrying case



Part #	Mfg #	Description	Price
165720	2403-22	M12 FUEL™ 1/2" Drill/Driver Kit	

M12™ Cordless Rotary Tool

- **Includes:**
 - M12™ Rotary tool (2460-20)
 - (1) REDLITHIUM™ Battery (48-11-2401)
 - (5) Cutting wheels, mandrel
 - Wrench
 - 30-Minute charger



Part #	Mfg #	Description	Price
162782	2460-20	M12™ Cordless Rotary Tool (Bare Tool)	
144497	2460-21	12V	

M12™ 1/4" Hex 2-Speed Screwdriver Kit

- Delivers up to 275 in-lbs of torque
- On-board battery fuel gauge displays remaining run time
- New ergonomic handle design for increased comfort
- 1/4" Hex quick change chuck for one-handed bit changes
- **Includes:**
 - (1) M12™ 1/4" Hex 2-speed screwdriver (2406-20)
 - (2) M12™ REDLITHIUM™ battery (48-11-2401)
 - (1) M12™ Lithium-ion battery charger (48-59-2401)
 - (1) Belt clip
 - (1) Carrying case



Part #	Mfg #	Description	Price
162004	2406-20	M12™ 1/4" Hex 2-Speed Screwdriver Tool Only	
162003	2406-22	M12™ 1/4" Hex 2-Speed Screwdriver Kit	

M12 FUEL™ 1/4" Hex 2-Speed Screwdriver Kit

- **POWERSTATE™ Brushless motor:** Delivers up to 325 in-lbs of peak torque with maximum sustained torque to complete a variety of applications
- **REDLITHIUM™ Battery technology:** Superior pack construction, electronics, and performance deliver more work per charge and more work over pack life than any battery on the market
- **REDLINK Plus™ Intelligence:** The most advanced system of cordless power tool electronics. Provides optimized performance and overload protection using total system communication between tool, battery and charger



Part #	Mfg #	Description	Price
165722	2402-22	M12 FUEL™ 1/4" Hex 2-Speed Screwdriver Kit	

M12™ Cordless Screwdriver

- Quick one-handed bit-loading
- Variable speed trigger
- No load speed: 0 to 500 rpm
- **Includes:**
 - M12™ Screwdriver (2401-20)
 - (2) 12V Lithium-Ion batteries
 - 12V Charger
 - Compact driver storage bag
- 5-Year warranty



Part #	Mfg #	Description	Price
137546	2401-22	100 in-lbs Torque	

Power Tools

M12™ 3/8" Drill/Driver Kit

- Delivers up to 275 in-lbs of torque
- On-board battery fuel gauge displays remaining run time
- Metal ratcheting chuck for maximum durability
- Includes:
 - (1) M12™ 3/8" Drill/Driver (bare tool) (2407-20)
 - (1) M12™ REDLITHIUM Battery (48-11-2401)
 - (1) M12™ Lithium-ion battery charger (48-59-2401)
 - (1) Belt clip
 - (1) Carrying case



Part #	Mfg #	Description	Price
162001	2407-20	3/8" Drill/Driver Tool Only	
162000	2407-22	3/8" Drill/Driver Kit	

M12™ 1/4" Hex Impact Driver Kit

- Milwaukee impact mechanism delivers 1,000 in-lbs of torque
- 0-2,500 RPM for increased fastening speed
- On-board battery fuel gauge displays remaining run time
- Includes:
 - (1) M12™ 1/4" Hex impact driver (2462-20)
 - (1) M12™ REDLITHIUM™ battery (48-11-2401)
 - (1) M12™ Lithium-ion battery charger (48-59-2401)
 - (1) Belt clip
 - (1) Carrying case



Part #	Mfg #	Description	Price
160215	2462-20	1/4" Impact Driver Tool Only	
160216	2462-22	1/4" Impact Driver Kit	

M12™ Cordless 1/4" Hex Impact Driver

- Battery fuel gauge displays remaining run-time
- Built-in LED light illuminates work surface
- Tool weight: 2.3 lbs
- No load speed: 0 to 2,000 rpm
- Torque: 850 in-lbs
- Kit includes:
 - M12™ 1/4" Hex impact driver (2450-20)
 - (2) Lithium-Ion batteries
 - 12V Charger
 - Carrying case
- 5-Year warranty



Part #	Mfg #	Description	Price
137551	2450-22	Impact Driver Kit	

M12™ 1/4" Impact Wrench Kit

- Lightweight, compact design allows for fastening in tight space
- New ergonomic handle design for increased comfort
- On-board battery fuel gauge displays remaining run time
- 1/4" anvil with friction ring for fast and easy socket changes
- Includes:
 - (1) M12™ 1/4" Impact wrench (2461-20)
 - (2) M12™ REDLITHIUM™ battery (48-11-2401)
 - (1) M12™ Lithium-ion battery charger (48-59-2401)
 - (1) Belt clip
 - (1) Carrying case



Part #	Mfg #	Description	Price
162010	2461-20	1/4" Impact Wrench Tool Only	
162009	2461-22	1/4" Impact Wrench Kit	

Power Tools

M12 FUEL™ 1/4" Impact Wrench Kit

- **POWERSTATE™ Brushless motor:** Delivers up to 500 in-lbs of peak torque with maximum sustained torque to complete a variety of applications
- **REDLITHIUM™ 2.0 Battery technology:** Superior pack construction, electronics, and performance deliver more work per charge and more work over pack life than any battery on the market
- **REDLINK Plus™ Intelligence:** The most advanced system of cordless power tool electronics. Provides optimized performance and overload protection using total system communication between tool, battery and charger
- **DRIVE CONTROL™:** Two fastening modes provide variable power and speed for precision work and heavy duty applications
- **Includes:**
 - (1) M12 FUEL™ 1/4" Impact wrench (bare tool) (2452-20)
 - (2) M12 REDLITHIUM™ 2.0 Compact battery pack (48-11-2420)
 - (1) M12™ Lithium-ion battery charger (48-59-2401)
 - (1) Belt clip
 - (1) Carrying case



Part #	Mfg #	Description	Price
165719	2452-22	M12 FUEL™ 1/4" Impact Wrench Kit	

M12 FUEL™ 3/8" Impact Wrench Kit

- **POWERSTATE™ Brushless motor:** delivers up to 1,400 in-lbs of peak torque with maximum sustained torque to complete a variety of applications
- **REDLITHIUM™ 2.0 Battery technology:** superior pack construction, electronics, and performance deliver more work per charge and more work over pack life than any battery on the market
- **REDLINK Plus™ Intelligence:** the most advanced system of cordless power tool electronics. Provides optimized performance and overload protection using total system communication between tool, battery and charger
- **DRIVE CONTROL™:** two fastening modes provide variable power and speed for precision work and heavy duty applications



Part #	Mfg #	Description	Price
165718	2454-22	M12 FUEL™ 3/8" Impact Wrench Kit	

M12™ 3/8" Impact Wrench Kit

- Milwaukee impact mechanism delivers 1,200 in-lbs of torque
- New ergonomic handle design for increased comfort
- On-board battery fuel gauge displays remaining run time
- 3/8" anvil with friction ring for fast and easy socket changes
- **Includes:**
 - (1) M12™ 3/8" Impact wrench (2463-20)
 - (2) M12™ REDLITHIUM™ battery (48-11-2401)
 - (1) M12™ Lithium-ion battery charger (48-59-2401)
 - (1) Belt clip
 - (1) Carrying case



Part #	Mfg #	Description	Price
162008	2463-20	3/8" Impact Wrench Only	
162006	2463-22	3/8" Impact Wrench Kit	

M12 FUEL™ 5/8" SDS Plus Rotary Hammer Kit

- **REDLINK™ Intelligence:** Provides optimized performance and overload protection using total system communication between tool, battery and charger
- **REDLITHIUM™ Battery technology:** Superior pack construction, electronics, and performance deliver more work per charge and more work over pack life than any battery on the market
- **Electro pneumatic mechanism:** Drills up to 5/8" holes in poured concrete and masonry
- **Powerful 12-volt motor:** Delivers 0-900 RPM and 0-6,200 BPM for superior performance
- **Compact, lightweight design:** Allows you to work comfortably in tight spaces and all day
- **2-Mode operation:** Choose rotary hammer or rotation only for maximum versatility
- **LED light:** Illuminates the work surface



Part #	Mfg #	Description	Price
165721	2416-22XC	M12 FUEL™ 5/8" SDS Plus Rotary Hammer Kit	

Power Tools

M12™ Cordless 1/4" Ratchet

- Torque: 30 ft-lbs
- Speed: 250 rpm
- Anvil: 1/4" ball detent
- Kit includes:
 - M12™ 1/4" Ratchet (2456-20)
 - (1) M12™ REDLITHIUM™ battery
 - 30-Minute charger
 - Carrying case



Part #	Mfg #	Description	Price
143703	2456-21	Ratchet Kit	

M12™ Cordless 3/8" Ratchet

- Torque: 35 ft-lbs
- Speed: 250 rpm
- Anvil: 3/8" ball detent
- Kit includes:
 - M12™ 3/8" Ratchet (2457-20)
 - M12™ REDLITHIUM™ Battery
 - 3/8" to 1/4" Adapter
 - 30-Minute charger
 - Carrying case



Part #	Mfg #	Description	Price
143706	2457-20	Ratchet Tool Only	

M12™ 102 X77 Infrared Camera

- 7,854 (102 x 77) pixel resolution captures highest resolution image in it's class
- DUAL SENSE™ pixels are ultra-responsive, adjusting individually to eliminate blurring of hot and cold details
- take measurements from long range or down to the detail with 83:1 distance-to-spot performance
- Measure surface temperatures 14°F to 626°F degrees for images spanning wide ranges
- 2-Stage trigger activates lasers for easy scanning or quickly captures images
- Dual lasers frame on-screen temperature area
- Multiple color palettes available: rainbow, grayscale and ironbow
- Automatically locates highest and lowest temperatures
- Fully compatible with Milwaukee® thermal imager reporting software available at Milwaukeeetool.com
- Compatible with over 70+ M12™ tools



Part #	Mfg #	Description	Price
185579	2258-21	M12™ 102 X 77 Infrared Camera	

M12™ M-Spector 360™ Rotating Inspection Scope

- Rotating display allows user to orient the image without having to fight the cable
- 640 x 480 Digital image sensor
- (4) LED lights
- Display: 2.7" LCD
- 9mm Aluminum head
- 3' Cable
- Includes:
 - M-Spector 360™ console
 - M12™ REDLITHIUM™ battery
 - 30 Minute charger
 - Hook, magnet and mirror attachments
 - Carrying case



Part #	Mfg #	Description	Price
148602	2313-21	Inspection Scope	
155645	2314-21	M-Spector 360™ ft Kit	

SUB-SCANNER™ M12™ Detection Tool

- Measures depth and location of Rebar up to 6" through concrete
- Detects location of wood and metal studs
- Differentiates between steel and copper or aluminum metals
- Intuitive user interface displays stud centers and edges
- High contrast white on black display and back light for easy reading
- Rugged over-molding improves durability and user grip
- One button calibration for all surfaces



Part #	Mfg #	Description	Price
153058	2291-20	SUBSCANNER™ M12™ Detection Tool	

Power Tools

M12™ Lithium-Ion Cordless Press Tools

M12™ Cordless ProPEX® Expansion Tool Kit

- Speed: 60 SPM
- Head rotation: built-in auto-rotator
- Head compatibility: 3/8" to 1" M12™/Uponor®
- LED Light
- Includes:
 - (2) Lithium-Ion batteries
 - 1/2" Expansion head
 - 3/4" Expansion head
 - 1" Expansion head
 - Grease
 - Carrying case
- 5-Year warranty



Part #	Mfg #	Description	Price
135837	2432-22	3/8" - 1" Capacity	

M12™ Force Logic™ Press Tool Kit

- Interchangeable jaw for quick adjustment from 1/2" to 1-1/4"
- Suitable for one-hand use
- 5-Second cycle time
- Press force: 5,400 lbs
- 32,000 Cycles between calibrations
- Includes:
 - M12™ Force Logic™ press tool (2473-20)
 - (2) M12™ REDLITHIUM™ batteries
 - 30-Minute charger
 - Hard carrying case
- 5-Year warranty on tool
- 2-Year warranty on jaws



Part #	Mfg #	Description	Price
150846	2473-20	Press Tool Kit	
150847	2473-22	Press Tool Kit w/1/2", 3/4" & 1" Jaws	

M12™ Force Logic™ Press Tool Jaw

- One-handed pressing solution for up to 1-1/4" pipe



Part #	Mfg #	Description	Price
150863	49-16-2450	1/2" Jaw	
150864	49-16-2451	3/4" Jaw	
150865	49-16-2452	1" Jaw	

M12™ Lithium-Ion Cordless Press Tools (Continued)

M12™ Force Logic™ Press Tool Jaw

Part #	Mfg #	Description	Price
150867	49-16-2453	1-1/4" Jaw	

M12™ Hackzall™ Cordless Reciprocating Saw

- 11" Long and 2.6 lbs for cutting in tight spaces
- 1/2" Stroke, 0 to 3,000 strokes per minute
- Keyless QUIK-LOK™ blade clamp allows for quick and easy blade changes
- All-metal gear case
- Variable speed trigger
- Battery fuel gauge displays remaining run-time
- Accepts both Hackzall™ and Sawzall® style blades
- Built-in LED light illuminates work surface
- 21 & 22 Suffixes include:
 - Hackzall™ (2420-20)
 - 30-Minute charger
 - (2) Hackzall™ blades
 - Carrying case
- 5-Year warranty



Part #	Mfg #	Description	Price
146874	2420-20	Saw Only	
137550	2420-21	Includes (1) M12™ Battery	

Power Tools

M12™ Cordless PVC Shear Kit

- Ultra sharp blade with pierce point
- Offset blade cuts PVC/PEX in-wall, in-ground, or close to wall
- Quick return blade
- All metal planetary drive
- Stainless steel blade and aluminum jaw
- Impact, water and rust resistant
- Variable speed trigger
- On board fuel gauge - displays remaining run-time
- Torque: 1,900 in-lbs
- Includes:
 - M12™ Cordless PVC shear (2470-20)
 - (1) Lithium-Ion battery
 - 30-Minute charger
 - Carrying case
- 5-Year warranty



Part #	Mfg #	Description	Price
152547	2470-20	M12™ Plastic Pipe Shear (Bare Tool)	
137552	2470-21	2" PVC Capacity	

M12™ AC/DC Wall Vehicle Charger

- 2-In-1 Design
- Charge time: 40 minutes
- Lithium-Ion battery (not included)
- 5-Year warranty



Part #	Mfg #	Description	Price
138274	2510-20	M12™ AC/DC Wall & Vehicle Charger	

M12™ Cordless Grease Gun

- Maximum operating pressure: 8,000 psi
- Grease capacity: 14 oz cartridge/16 oz bulk
- Includes:
 - M12™ Grease gun (2446-20)
 - M12™ XC REDLITHIUM™ battery
 - 60-Minute charger
 - 36" High pressure flex hose with spring guard
 - Grease coupler
 - Carrying case



Part #	Mfg #	Description	Price
141426	2446-21XC	M12™ Grease Gun	

M12™ Cordless LITHIUM-ION Multi-Tool

- Cuts, grinds, sands and scrapes
- Variable speed dial
- On board fuel gauge displays run time
- Runs 5,000 to 20,000 OPM
- Kit includes:
 - Cordless multi-tool
 - Accessory adapter
 - Wood cutting blade
 - (1) REDLITHIUM™ battery
 - 30-Minute charger
 - Contractor bag



Part #	Mfg #	Description	Price
143165	2426-21	M12™ LITHIUM-ION Multi-Tool Kit	

M12™ Cordless Copper Tubing Cutter

- Close quarter rotating cutting head cuts pipe in confined spaces
- Automatic adjustment from 3/8" to 1" tubing
- Auto locking mechanism delivers up to 200 cuts per charge
- Water resistant sealed metal cutter head
- Battery fuel gauge displays remaining run time
- Built-in LED light illuminates line of cut
- 14" Long, 3.2 lbs tool weight
- No load speed: 500 rpm
- Capacity: 1/2" to 1-1/8" OD
- Kit includes:
 - Tubing cutter (2471-20)
 - (2) 12V Lithium-Ion battery (2471-21 is single battery kit)
 - 30-Minute charger
 - Carrying case
- 5-Year warranty



Part #	Mfg #	Description	Price
148546	2471-20	Tubing Cutter Only	
137554	2471-21	Tubing Cutter Kit	

Copper Cutter Wheels

- Hardened steel with black oxide
- Convex blade design
- For use with Milwaukee® 12V copper tubing cutter model 2471



Part #	Mfg #	Description	Price
138792	48-38-0010	Copper Cutter Replacement Blades 2/Pk	

Power Tools

M12™ Cordless Multi-Tool

- Cuts, grinds, sands and scrapes
- Variable speed dial
- On board fuel gauge displays run time
- Runs 5,000 to 20,000 OPM
- Includes:
 - Cordless multi-tool
 - Accessory adapter
 - Wood cutting blade
 - Sanding pad
 - (5) Assorted sanding sheets
 - (2) REDLITHIUM™ batteries
 - 30-Minute charger
 - Contractor bag



Part #	Mfg #	Description	Price
139011	2426-22	M12™ Multi-Tool Kit	

M12™ Cordless 2-Tool Combo Kit

- 1/4" Hex screwdriver delivers 150 in-lbs of torque, 15 position clutch, and 0 to 500 rpm
- Hackzall™ reciprocating saw delivers 0 to 3000 spm
- Includes:
 - Screwdriver (2401-20)
 - Hackzall™ Reciprocating saw (2420-20)
 - (2) M12™ Lithium-Ion batteries
 - 30-Minute charger
 - (2) Hackzall™ blades
 - Contractor bag
- 5-Year warranty



Part #	Mfg #	Description	Price
137556	2490-22	150 in-lbs Torque	

M12™ Cordless LITHIUM-ION 2-Tool Combo Kit



Part #	Mfg #	Description	Price
163696	2497-22	M12™ Cordless LITHIUM-ION 2-Tool Combo Kit	

M12™ Cordless 4-Tool Combo Kit

- Hackzall™ reciprocating saw delivers 0 to 3000 spm
- Copper tubing cutter automatically adjusts to cut 3/8" to 1" copper tube
- Work light illuminates large work area with 90° rotating head and integrated magnet
- Includes:
 - Screwdriver (2401-20)
 - Hackzall™ reciprocating saw (2420-20)
 - Copper tubing cutter (2471-20)
 - Work light (49-24-0145)
 - (2) 12V Lithium-Ion battery packs
 - 30-Minute charger
 - (2) Hackzall™ blades
 - Contractor bag



Part #	Mfg #	Description	Price
138377	2490-24	150 in-lbs Torque	

M12™ Cordless 2-Tool Combo Kit (1)

- Includes:
 - 1/4" Hex Impact driver (2450-20)
 - Hackzall™ Reciprocating saw (2420-20)
 - (2) Lithium-Ion batteries
 - 30-Minute charger
 - Contractor bag
- 5-Year warranty



Part #	Mfg #	Description	Price
139268	2491-22	12V	

M12™ Cordless 2-Tool Combo Kit

- Includes:
 - 3/8" Drill driver (2410-20)
 - 1/4" Hex impact driver (2450-20)
 - (2) M12™ REDLITHIUM™ Batteries (48-11-2401)
 - 30-Minute charger (48-59-2401)
 - Contractor bag
- 5-Year warranty



Part #	Mfg #	Description	Price
137558	2494-22	12V	

Power Tools

M12 Fuel™ Cordless Tools

M12 FUEL™ 1/2" Hammer Drill/Driver Kit

- POWERSTATE™ Brushless motor
- REDLINK Plus™ Intelligence
- REDLITHIUM™ Battery technology
- Includes:
 - (1) M12 FUEL™ 1/2" hammer drill/driver (2404-20)
 - (1) M12 REDLITHIUM™ 2.0 compact battery pack (48-11-2420)
 - (1) M12™ REDLITHIUM™ XC 4.0 extended capacity battery pack (48-11-2440)
 - (1) M12™ Lithium-ion battery charger (48-59-2401)
 - (1) Belt clip
 - (1) Carrying case



Part #	Mfg #	Description	Price
154724	2404-22	M12 FUEL™ 1/2" Hammer Drill/Driver Kit	

M12 FUEL™ 1/4" Hex Impact Driver

- POWERSTATE™ Brushless motor: Delivers 1,200 in-lbs of peak torque with maximum sustained torque to complete a variety of applications
- REDLITHIUM™ 2.0 Battery technology: Superior pack construction, electronics, and performance deliver more work per charge and more work over pack life than any battery on the market
- REDLINK Plus™ Intelligence: The most advanced system of cordless power tool electronics. Provides optimized performance and overload protection using total system communication between tool, battery and charger
- DRIVE CONTROL™: Two fastening modes provide variable power and speed for precision work and heavy duty applications
- Includes:
 - (1) M12 FUEL™ 1/4" hex impact driver (2453-20)
 - (2) M12 REDLITHIUM™ 2.0 compact battery pack (48-11-2420)
 - (1) M12™ Lithium-ion battery charger (48-59-2401)
 - (1) Belt clip
 - (1) Carrying case



Part #	Mfg #	Description	Price
159974	2453-20	M12 Fuel™ 1/4" Hex Impact Driver Tool Only	
154725	2453-22	M12 FUEL™ 1/4" Hex Impact Driver Kit	

M12 FUEL™ 2-Tool Combo Kit



Part #	Mfg #	Description	Price
164845	2597-22	M12 FUEL™ 2-Tool Combo Kit	

M12 FUEL™ HACKZALL® Recip Saw Kit

- One-handed design provides superior control & versatility over a standard recip saw
- Compact size allows for cutting in tight spaces, and light weight makes overhead work easier
- POWERSTATE™ brushless motor supplies constant power for faster cuts and reduced heat for extended life
- REDLINK PLUS™ Intelligence provides optimized performance and overload protection using total system communication between tool, battery and charger
- REDLITHIUM™ XC 4.0 Battery pack provides superior pack construction, more work per charge and more work over the life of the pack than competitive batteries



Part #	Mfg #	Description	Price
166203	2520-20	M12 FUEL™ HACKZALL® Recip Saw (Bare Tool)	
166202	2520-21XC	M12 FUEL™ HACKZALL® Recip Saw Kit	

M12™ Cordless LITHIUM-ION 4-Tool Combo Kit

- Includes:
 - (1) M12™ 3/8" Drill/Driver (bare tool) (2407-20)
 - (1) M12™ HACKZALL® Recip saw (bare tool) (2420-20)
 - (1) M12™ 1/4" Hex impact driver (bare tool) (2462-20)
 - (2) M12™ REDLITHIUM™ Battery (48-11-2401)
 - (1) M12™ Lithium-ion battery charger (48-59-2401)
 - (1) M12™ Work light (49-24-0145)
 - (1) Contractor bag



Part #	Mfg #	Description	Price
159666	2498-24	M12™ Cordless LITHIUM-ION 4-Tool Combo Kit	

Power Tools

M12 Fuel™ Miscellaneous Tools

M-Spector™ Inspection Scope Kit

- 2.7" LCD display
- Four surround LED lights
- 3 ft enhanced cable
- Includes:
 - (1) M-Spector™ Scope Kit
 - (1) Pipe guide attachment
 - (1) 9V Battery
 - (1) Carrying case



Part #	Mfg #	Description	Price
229565	2309-20	M12™ M-Spector™	

M12™ Job site Radio

- Digital reception with signal processor
- 1/8" Stereo jack auxiliary input
- Includes:
 - Job site radio
 - Auxiliary input cord
 - AC Adapter
 - (2) AAA Batteries for memory backup
- Battery and charger sold separately
- 3.6 lbs



Part #	Mfg #	Size	Price
139355	2590-20	10-1/2" x 7" x 4"	

M18™ Lithium-Ion Cordless Drills

M18™ Cordless Right Angle Drill

- No load speed: 0 to 1550 rpm
- Torque: 125 in-lbs
- Chuck type: 3/8" single sleeve ratcheting
- Includes:
 - M18™ Right angle drill (2615-20)
 - M18™ REDLITHIUM™ XC High capacity battery
 - 1-Hour charger
 - Carrying case



Part #	Mfg #	Description	Price
162304	2615-20	M18™ Cordless Right Angle Drill (Bare Tool)	
142940	2615-21	Right Angle Drill Kit	

M18™ 1/2" High Performance Hammer/Drill Driver

- 4-Pole frameless motor
- 1/2" Single-sleeve ratcheting metal chuck with carbide jaws
- Battery fuel gauge displays remaining run-time
- Built-in LED light illuminates work surface
- Variable speed trigger
- No load speed: 0 to 1,800 rpm
- No load BPM: 0 to 28,000 BPM
- Includes:
 - (2) M18™ 18V XC Lithium-Ion batteries
 - 18V Charger
 - Side handle
 - Carrying case
- 5-Year warranty



Part #	Mfg #	Description	Price
139122	2611-24	650 in-lbs Torque	

M18™ Compact Drill Driver

- Built-in LED light
- 18V DC
- No load speed: 350 to 1,400 rpm
- Torque: 425 in-lbs
- Kit includes:
 - M18™ Compact drill driver (2601-20)
 - (2) 18V Lithium-Ion batteries
 - 18V Lithium-Ion charger
 - 1/2" 3-Jaw keyless chuck
- 5-Year warranty



Part #	Mfg #	Description	Price
137559	2601-22	Drill Driver Kit	

M18™ FUEL™ 1/2" Drill/Driver Kit

- Torque: 725 in-lbs
- 2-Speed
- Includes:
 - M18™ FUEL™ 1/2" Drill/driver (2603-20)
 - (2) M18™ REDLITHIUM™ XC High capacity batteries
 - Multi-voltage charger
 - Carrying case



Part #	Mfg #	Description	Price
155163	2603-20	M18™ 1/2" Drill/Driver (Bare Tool)	
148728	2603-22	FUEL Drill/Driver Kit	

Power Tools

M18™ Compact Hammer Drill Driver

- 4-Pole frameless motor
- 1/2" Single-sleeve ratcheting metal chuck
- Variable speed trigger
- No load speed: 0 to 1,700 rpm
- No load BPM: 0 to 29,000 BPM
- Torque: 550 in-lbs
- Kit includes:
 - M18™ Hammer-drill driver (2602-22)
 - (2) 18V XC Lithium-Ion batteries
 - 1-Hour 18V charger
 - Carrying case
- 5-Year warranty



Part #	Mfg #	Description	Price
143056	2602-20	Hammer Drill Driver Only	
137560	2602-22	Hammer Drill Driver Kit	

M18™ 1/4" Hex Compact Impact Driver

- 1/4" Hex quick change chuck
- 4-Pole frameless motor
- Battery fuel gauge displays remaining run-time
- No load speed: 0 to 2,200 rpm
- No load IPM: 0 to 3,200 IPM
- Variable speed trigger
- Built-in LED light illuminates work surface
- 18V
- Includes:
 - M18™ Impact driver (2650-20)
 - (2) M18™ REDLITHIUM™ XC high capacity batteries
 - Battery charger
 - Belt clip
 - Carrying case
- 5-Year warranty



Part #	Mfg #	Description	Price
144367	2650-20	Impact Driver Only	
137562	2650-22	Impact Driver Kit	

M18™ FUEL™ 1/2" Hammer Drill/Driver Kit

- 2-Speed Powerstate™ brushless motor
- Redlink PLUS™ Intelligence system communications with overload protection
- No load speed: 0 to 500/0 to 1850 rpm
- Includes:
 - 1/2" Drill/driver (2603-20)
 - (2) 18V Compact REDLITHIUM™ batteries
 - Multi-voltage charger
 - Locking chuck
 - LED Light
- 5-Year warranty



Part #	Mfg #	Description	Price
157955	2604-20	M18 FUEL™ 1/2" Hammer Drill/Driver (Bare Tool)	
148727	2604-22	725 in-lbs Torque with Cushion Grip	

Power Tools

M18 2-Speed 1/4" Hex Impact Driver Kit

- Milwaukee® 4-Pole frameless motor: features a robust design for longer life, more power and more runtime than any brushed competitor
- Milwaukee® designed impact mechanism: Delivers maximum power and application speed for greater efficiency on the job
- REDLINK™ Intelligence: Provides optimized performance and overload protection using total system communication between tool, battery and charger
- Proprietary 2-Mode DRIVE CONTROL™ Two speed/torque modes allow class-leading control for greater application versatility
- 1/4" Hex quick-connect chuck
- REDLITHIUM™ Battery technology: superior pack construction, electronics, and performance deliver more work per charge and more work over pack life than any battery on the market
- Includes:
 - (1) M18 2-Speed 1/4" hex impact driver (Bare tool) (2657-20)
 - (2) M18™ Compact REDLITHIUM™ battery (48-11-1815)
 - (1) M18™ & M12™ Multi-voltage charger (48-59-1812)
 - (1) Belt clip
 - (1) Carrying case



Part #	Mfg #	Description	Price
164016	2657-20	M18™ 2-Speed 1/4" Hex Impact Driver Kit	

M18 FUEL™ 1/4" Hex Impact Driver Kit

- 1/4" Hex quick change chuck
- 4-Pole frameless motor
- Battery fuel gauge displays remaining run-time
- Torque: 1,600 in-lbs
- No load speed: 0 to 3,600 rpm
- No load IPM: 0 to 2,900
- Variable speed trigger
- Built-in LED light illuminates work surface
- Includes:
 - Impact driver (2653-20)
 - (2) 18V REDLITHIUM™ XC High capacity batteries
 - 30-Minute multi-voltage charger
 - Belt clip
 - Carrying case
- 5-Year warranty



Part #	Mfg #	Description	Price
163681	2653-20	M18 FUEL™ 1/4" Hex Impact Driver (Bare Tool)	
148691	2653-22	Impact Driver Kit	

M18™ 3/8" Compact Impact Wrench with Friction Ring Kit

- Milwaukee® 4-Pole frameless motor
- Milwaukee® engineered impact mechanism
- REDLITHIUM™ battery technology
- REDLINK™ Intelligence
- Includes:
 - (1) M18™ 3/8" compact impact wrench with friction ring (2651-20)
 - (2) M18™ REDLITHIUM™ XC extended capacity battery (48-11-1828)
 - (1) M18™ & M12™ multi-voltage charger (48-59-1812)
 - (1) Carrying case



Part #	Mfg #	Description	Price
152299	2651-22	M18™ 3/8" Compact Impact Wrench with Friction Ring Kit	

Power Tools

M18™ 3/8" Impact Wrench Kit with Friction Ring

- Milwaukee® 4-Pole frameless motor: features a robust design for longer life, more power and more runtime than any brushed competitor
- Milwaukee® designed impact mechanism: delivers maximum power and application speed for greater efficiency on the job
- REDLINK™ Intelligence: provides optimized performance and overload protection using total system communication between tool, battery and charger
- REDLITHIUM™ Battery technology: superior pack construction, electronics, and performance deliver more work per charge and more work over pack life than any battery on the market
- 3/8" Anvil with friction ring
- Includes:
 - (1) M18™ 3/8" Impact wrench with friction ring (bare tool) (2658-20)
 - (2) M18™ REDLITHIUM™ XC Extended capacity battery (48-11-1828)
 - (1) M18™ & M12™ Multi-voltage charger (48-59-1812)
 - (1) Belt clip
 - (1) Carrying case



M18 FUEL™ 1/2" High Torque Impact Wrench with Friction Ring Kit

- Superior performance: delivers up to 700 ft-lbs of maximum fastening torque, up to 1,100 ft-lbs of nut-busting torque and up to 2X more runtime
- POWERSTATE™ brushless motor: outpowers competitors yet runs cooler with no wearable components
- REDLINK PLUS™ intelligence: allows the operator to choose between 2 fastening modes with Milwaukee's proprietary DRIVE CONTROL™ feature. Mode 1 delivers up to 100 ft-lbs of maximum fastening torque, and Mode 2 up to 700 ft-lbs of maximum fastening torque
- REDLITHIUM™ XC 5.0 battery pack: provides superior pack construction, electronics and performance to deliver 2X more runtime
- 1/2" Anvil with friction ring for fast, easy socket changes
- Includes:
 - (1) M18 FUEL™ 1/2" High torque impact wrench with friction ring (bare tool) (2763-20)
 - (1) M18™ & M12™ Multi-voltage charger (48-59-1812)
 - (2) M18™ REDLITHIUM™ XC5.0 Extended capacity battery pack (48-11-1850)
 - (1) Carrying case



Part #	Mfg #	Description	Price
166198	2658-22	M18™ 3/8" Impact Wrench Kit with Friction Ring	

Part #	Mfg #	Description	Price
165987	2763-22	M18 FUEL™ 1/2" High Torque Impact Wrench with Friction Ring Kit	

Power Tools

M18™ 1/2" Compact Impact Wrench with Pin Detent Kit

- Milwaukee® 4-Pole frameless motor: Features a robust design combined with rare-earth magnets for longer life, more power and more runtime than any brushed competitor
- Milwaukee® engineered impact mechanism: delivers maximum application speed for greater efficiency on the job
- REDLITHIUM™ Battery technology: superior pack construction, electronics, and performance deliver more work per charge and more work over pack life than any battery on the market.
- REDLINK™ Intelligence: provides optimized performance and overload protection using total system communication between tool, battery, and charger
- Includes:
 - (1) M18™ 1/2" Compact impact wrench with pin detent (bare tool) (2652-20)
 - (1) M18™ REDLITHIUM™ XC Extended capacity battery (48-11-1828)
 - (1) M18™ REDLITHIUM™ XC Extended capacity battery (48-11-1828)
 - (1) M18™ & M12™ Multi-voltage charger (48-59-1812)
 - (1) Carrying case



Part #	Mfg #	Description	Price
159510	2652-22	M18™ 1/2" Compact Impact Wrench with Pin Detent Kit	

M18™ 1/2" High-Torque Impact Wrench with Friction Ring Kit

- Milwaukee® 4-pole frameless motor
- REDLITHIUM™ battery technology
- REDLINK™ intelligence
- Includes:
 - (1) M18™ 1/2" high-torque impact wrench with friction ring (2663-20)
 - (2) M18™ REDLITHIUM™ XC extended capacity battery (48-11-1828)
 - (1) M18™ & M12™ Multi-voltage charger (48-59-1812)
 - (1) Carrying case



Part #	Mfg #	Description	Price
152298	2663-22	1/2" High-Torque Impact Wrench with Friction Ring Kit	

M18™ Cordless 5/8" SDS Plus Rotary Hammer Kit

- REDLITHIUM™ battery technology: superior pack construction, electronics, and performance deliver more work per charge and more work over pack life than any battery on the market
- Powerful 18-volt motor: delivers 0-1,300 RPM and 0-7,000 BPM
- 2-Mode operation: choose rotary hammer or rotation only for added versatility
- LED light: illuminates dark work spaces



Part #	Mfg #	Description	Price
166128	2612-21	M18™ Cordless 5/8" SDS Plus Rotary Hammer Kit	

M18™ Cordless Lithium-Ion 7/8" SDS-Plus Rotary Hammer Kit

- REDLITHIUM™ Battery technology: Superior pack construction, electronics, and performance deliver more work per charge and more work over pack life than any battery on the market
- Powerful 18-volt motor: Delivers 0-1,400 RPM, 0-4,800 BPM and up to 40% more runtime than the competition
- 1.4 Ft-lbs of torque: Provides 10% faster drilling and up to 35% harder hitting
- 3-Mode operation: Choose rotary hammer, hammer only and rotation only for added versatility
- Mechanical clutch: Protects the motor when the bit binds
- Variable position chisel stop: Allows steel to be adjusted, regardless of orientation
- AVS Anti-vibration system: Minimizes vibration for maximum comfort
- Digital power management: Prevents damage to the tool in harsh jobsite condition



Part #	Mfg #	Description	Price
159511	2605-22	M18™ Cordless Lithium-Ion 7/8" SDS-Plus Rotary Hammer Kit	

Power Tools

M18 Fuel™ Cordless Drills

M18™ FUEL™ 1/2" Hammer Drill/Driver

- POWERSTATE™ brushless motor
- REDLINK PLUS™ Intelligence prevents damage
- No load RPM: 0-550/0-2,000
BPM: 32,000
- Includes:
 - 1/2" 18V Hammer Drill/Driver
 - Side handle
 - Belt clip
- 5-Year warranty



Part #	Mfg #	Description	Price
179573	2704-20	Tool Only, 1,200 in-lbs Torque	

M18 FUEL™ 3/8" Impac Wrench Kit with Friction Ring

- Delivers a best-in class 200 ft-lbs and 2,400 in-lbs of torque in a compact design
- The Milwaukee® POWERSTATE™ brushless motor provides increased efficiency, lasts longer and delivers maximum power
- REDLINK PLUS™ electronic intelligence allows the operator to choose between 3 fastening modes with Milwaukee's proprietary DRIVE CONTROL™ feature
- The Milwaukee® REDLITHIUM™ battery pack is the most durable pack on the market and provides up to 50% more run time
- Utilizes a friction ring design for fast, easy socket changes
- Includes:
 - (1) M18 FUEL™ 3/8" Impact wrench with friction ring (2654-20)
 - (2) M18™ REDLITHIUM™ XC 4.0 Extended capacity battery pack (48-11-1840)
 - (1) M18 & M12™ multi-voltage charger (48-59-1812)
 - (1) Belt clip
 - (1) Carrying case



Part #	Mfg #	Description	Price
158102	2654-22	M18 Fuel™ 3/8" Impact Wrench Kit with Friction Ring	

M18 FUEL™ 1/2" Impact Wrench Kit with Pin Detent

- Delivers a best-in-class 210 ft-lbs and 2,520 in-lbs of torque in a compact design
- The Milwaukee® POWERSTATE™ Brushless Motor provides increased efficiency, lasts longer and delivers maximum power
- REDLITHIUM™ XC 4.0 Battery pack is the most durable pack on the market and provides up to 2X more run time
- REDLINK PLUS™ electronic intelligence allows the operator to choose between 3 fastening modes with Milwaukee's proprietary DRIVE CONTROL™ feature
- Utilizes a pin detent design for maximum socket retention
- Includes:
 - (1) M18 FUEL™ 1/2" Impact wrench with pin detent(bare tool) (2655-20)
 - (2) M18™ REDLITHIUM™ XC 4.0 extended capacity battery pack (48-11-1840)
 - (1) M18™ & M12™ multi-voltage charger (48-59-1812)
 - (1) Belt clip
 - (1) Carrying case



Part #	Mfg #	Description	Price
158103	2655-22	M18 FUEL™ 1/2" Impact Wrench Kit with Pin Detent	

M18™ Cordless Saws

M18™ Sawzall® Reciprocating Saw Kit

- Gear-protecting clutch
- Lever action Quik-Lok™ blade clamp
- Battery fuel gauge displays remaining run-time
- Variable speed trigger
- Includes:
 - Sawzall® 1" Reciprocating saw (2620-20)
 - (1) 1-Hour charger
 - (1) Sawzall® blade
 - Carrying case
- 5-Year warranty



Part #	Mfg #	Description	Price
142639	2620-20	Sawzall® Saw Tool Only	
138283	2620-21	Sawzall® with (1) 18V XC High Capacity Lithium-Ion Batteries	

Power Tools

M18™ HACKZALL® Cordless One-Handed Reciprocating Saw

- Speed: 0 to 3,000 spm
- Stroke length: 3/4"
- Blade clamp: QUIK-LOK™ universal



- Kit includes:
 - M18™ HACKZALL® Reciprocating saw (2625-20)
 - M18™ REDLITHIUM™ XC High capacity battery
 - 10-Hour charger
 - SAWZALL® Blade
 - Contractor bag

Part #	Mfg #	Description	Price
144657	2625-20	Reciprocating Saw Only	
138662	2625-21	Reciprocating Saw Kit	

M18™ HACKZALL® Recip Saw Kit

- One-handed design provides superior control & versatility
- Compact size allows for cutting in tight spaces, and light weight makes overhead work easier
- Built-in LED light



- Includes:
 - (1) M18™ HACKZALL® Recip Saw (2625-20)
 - (1) M18™ Compact REDLITHIUM Battery (48-11-1815)
 - (1) M18™ & M12™ Multi-Voltage Charger (48-59-1812)
 - (1) Contractor Bag

Part #	Mfg #	Description	Price
150993	2625-21CT	Reciprocating Saw Kit	

M18™ Cordless Band Saw

- 3-1/4" Cut capacity
- Tool-free adjustable material shoe
- LED Work light
- Blade ejection system
- Drop resistant pulley guard
- Cast aluminum gear case



- Kit includes:
 - M18™ Band saw
 - (2) M18™ REDLITHIUM™ XC High capacity batteries
 - 1-Hour charger
 - Blade
 - Case
- 5-Year warranty

Part #	Mfg #	Description	Price
143146	2629-22	Band Saw Kit	

M18 FUEL™ 6-1/2" Circular Saw Kit

- POWERSTATE™ Brushless motor: Outpowers all other 18-volt cordless circular saws and provides up to 3X longer tool life
- REDLINK PLUS™ Intelligence: The most advanced electronic system on the market maximizes performance
- REDLITHIUM™ XC 4.0 Battery pack: Offers up to 4X more runtime, 20% more power and up to 2X more recharges than competitive batteries



- Includes:
 - (1) M18 FUEL™ 6-1/2" Circular saw (bare tool) (2730-20)
 - (1) M18™ REDLITHIUM™ XC 4.0 Extender capacity battery pack (48-11-1840)
 - (1) M18™ & M12™ Multi-voltage charger (48-59-1812)
 - (1) Blade
 - (1) Blade wrench
 - (1) Contractor bag

Part #	Mfg #	Description	Price
162303	2730-20	M18 FUEL™ 6-1/2" Circular Saw (Bare Tool)	
161702	2730-22	M18 FUEL™ 6-1/2" Circular Saw Kit	

Power Tools

M18™ Cordless 6-1/2" Circular Saw

- Speed: 3,500 rpm
- Capacity: 2-1/8" @90° and 1-9/16" @45°
- Arbor: 5/8"
- Blade: 6-1/2" 24T carbide tipped
- Kit includes:
 - M18™ Circular saw (2630-20)
 - (2) M18™ REDLITHIUM™ XC High capacity batteries
 - 1-Hour charger
 - Contractor bag



Part #	Mfg #	Description	Price
138753	2630-22	Circular Saw Kit	

M18™ Cordless Jig Saw

- Speed: 0 to 2,700 SPM
- Stroke length: 1"
- Bevel capacity: 45°
- Kit includes:
 - M18™ Jig saw (2645-20)
 - (2) M18™ REDLITHIUM™ XC High capacity batteries
 - 1-Hour charger
 - Jig saw blade
 - Non-marring shoe
 - Carrying case



Part #	Mfg #	Description	Price
138656	2645-22	Jig Saw Kit	

M18™ Cordless 5-3/8" Metal Saw

- 4-Pole frameless motor
- Speed: 3,600 rpm
- Cut capacity: 1/8" to 2"
- Blade: 5-3/8" 30T carbide-tipped
- Includes:
 - M18™ 5-3/8" Metal saw
 - (2) M18™ REDLITHIUM™ XC High capacity batteries
 - 1-Hour charger
 - 30T Metal Tech™ carbide-tipped blade
 - Blade wrench
 - Contractor bag



Part #	Mfg #	Description	Price
141828	2682-22	Metal Saw Kit	

M18™ Fuel Cordless Saws

M18 Fuel™ Sawzall® Reciprocating Saw Kit

- Delivers faster than corded cutting speed and the durability of a corded saw
- POWERSTATE™ Brushless motor
- REDLINK PLUS™ Intelligence
- REDLITHIUM™ XC 4.0 Battery pack
- 2720-22, 2720-21 Kit Includes:
 - (1) M18 FUEL™ SAWZALL® reciprocating saw (2720-20)
 - (1) M18™ REDLITHIUM™ XC 4.0 extended capacity battery pack (48-11-1840)
 - (1) M18™ & M12™ Multi-voltage charger (48-59-1812)
 - (1) Blade
 - (1) Carrying case



Part #	Mfg #	Description	Price
161655	2720-20	M18 FUEL™ SAWZALL® Reciprocating Saw (Bare Tool)	
161658	2720-21	M18 Fuel™ SAWZALL® Reciprocating Saw Kit	
161581	2720-22	M18 Fuel™ SAWZALL® Reciprocating Saw Kit	

M18™ Lithium-Ion Cordless Press Tools

M18™ ProPEX™ Expansion Tool Kit

- Built-in Auto Rotate Head
- Led Work Light
- Quick Cam Mechanism Delivers Precise Continuous Expansion for 3/8"-1-1/2" ProPEX™
- D-Handle Design and Integrated Magnesium Frame Provides Job site Durability
- Includes:
 - (1) M18™ Cordless LITHIUM-ION ProPEX® Expansion Tool (2632-20)
 - (2) M18™ REDLITHIUM™ XC Extended Capacity Battery (48-11-1828)
 - (1) M18™ & M12™ Multi-Voltage Charger (48-59-1812)
 - (1) ProPEX Expander Cone Grease (49-08-2400)
 - (1) 1" M18™ ProPEX® Expansion Head
 - (1) 1-1/4" M18™ ProPEX® Expansion Head
 - (1) 1-1/2" M18™ ProPEX® Expansion Head



Part #	Mfg #	Description	Price
173693	2632-22XC	2632-22XC M18 Propex EXP Kit XC	

Power Tools

M18™ FORCE LOGIC™ 2"-3" ProPEX® Expansion Tool Kit

- Expands 2", 2-1/2" and 3" Uponor® large diameter PEX pipe
- Auto-rotate mechanism expands Uponor® PEX pipe quickly & evenly
- Auto-cycle: Rotates, expands and resets automatically simplifying installation process
- Intelligent design delivers optimum balance for overhead connections, and flips over for extended use on table-top
- LED light delivers better visibility in lower-lit areas
- Includes:
 - (1) 2-1/2" ProPEX® Expansion head (49-16-2616)
 - (1) 2" ProPEX® Expansion head (49-16-2614)
 - (3) 3" ProPEX® Expansion head (49-16-2618)
 - (2) M18™ REDLITHIUM™ XC 4.0 extended capacity Battery Pack (48-11-1840)
 - (1) M18™ & M12™ Multi-voltage charger (48-59-1812)
 - (1) 150g ProPEX® Expander cone grease (49-08-2401)
 - (1) Carrying case
 - (1) Side handle



Part #	Mfg #	Description	Price
182828	2633-22	M18™ FORCE LOGIC™ 2"-3" ProPEX® Expansion Tool Kit	

M18™ Force Logic™ Press Tool Kit

- Interchangeable jaw for quick adjustment from 1/2" to 2"
- Suitable for 1-hand use
- 5-Second cycle time
- Press force: 7,200 lbs
- 40,000 Cycles between calibrations
- Kit includes:
 - M18™ Force Logic™ press tool (2673-20)
 - (2) M18™ REDLITHIUM™ batteries
 - (6) Jaws - 1/2", 3/4", 1", 1-1/4", 1-1/2" and 2"
 - 30-Minute charger
 - Hard carrying case
- 5-Year warranty on tool
- 2-Year warranty on jaws



Part #	Mfg #	Description	Price
150848	2673-20	Press Tool Only	
150849	2673-22	Press Tool Kit	

M18™ FORCE LOGIC™ Press Tool Kit with 1/2"-2" Jaws

- Lightest, In-line design for unrivaled access
- Auto-cycle ensures full press every time
- Longest calibration interval in the industry at 50,000 cycles
- Industry's first brushless press tool
- In-line design optimized for one-handed presses
- Includes:
 - (1) M18™ FORCE LOGIC™ Press Tool (2773-20)
 - (2) M18™ REDLITHIUM™ 2.0 Compact battery pack (48-11-1820)
 - (1) M18™ & M12™ Multi-voltage charger (48-59-1812)
 - (1) M18™ 1/2" Jaw (49-16-2650)
 - (1) M18™ 3/4" Jaw (49-16-2651)
 - (1) M18™ 1" Jaw (49-16-2652)
 - (1) M18™ 1 1/4" Jaw (49-16-2653)
 - (1) M18™ 1 1/2" Jaw (49-16-2654)
 - (1) M18™ 2" Jaw (49-16-2655)



Part #	Mfg #	Description	Price
229336	2773-20	M18™ Force Logic™ Tool Only	
226110	2773-22	M18™ FORCE LOGIC™ Press Tool Kit with 1/2"-2" Jaws	

M18™ Force Logic Press Tool Jaw



Part #	Mfg #	Jaw Size	Price
150851	49-16-2650	1/2"	
150852	49-16-2651	3/4"	
150853	49-16-2652	1"	
150854	49-16-2653	1-1/4"	
150855	49-16-2654	1-1/2"	
150857	49-16-2655	2"	
150859	49-16-2656	2-1/2"	

Power Tools

M18™ Force Logic Press Tool Ring

- Presses 2-1/2" to 4" pipes



Part #	Mfg #	Ring Size	Price
150860	49-16-2657	3"	
150861	49-16-2658	4"	

M18™ Force Logic Press Tool Ring Jaw 1

- For use with M18™ Force Logic™ standard rings



Part #	Mfg #	Description	Price
150862	49-16-2659	Ring Jaw 1	

M18™ Black Iron Press Ring

- Designed for use on Viega® MegaPress® fittings
- Dual pivot design provides superior close quarter access and uniform pressing force
- Up to 30% lighter than the leading competitor
- Compatible with M18™ force logic press tool. Use with ring jaw 1



Part #	Mfg #	Description	Price
226139	49-16-2655B	M18™ 2" Black Iron Press Ring	

M18™ Short Throw Press Tool Kit w/ Viega PureFlow™ Jaws

- Designed for one handed use
- Auto cycle ensures full press every time
- 40% Faster press
- No calibration interval
- Optimized for residential installs
- Includes
 - (2) M18™ REDLITHIUM™ 2.0 Compact battery pack (48-11-1820)
 - (1) M18™ & M12™ Multi-voltage charger (48-59-1812)
 - (1) M18™ 1/2" Viega PureFlow™ jaw for M18™ short throw press tool (49-16-2631P)
 - (1) M18™ 3/4" Viega PureFlow™ jaw for M18™ short throw press tool (49-16-2633P)
 - (1) M18™ 1" Viega PureFlow™ jaw for M18™ short throw press tool (49-16-2634P)
 - (1) Carrying case



Part #	Mfg #	Description	Price
228433	2674-22P	M18™ Short Throw Press Tool Kit w/ Viega PureFlow™ Jaws	

Power Tools

M18™ Knockout Tools

FORCELOGIC™ M18™ 10 Ton Knockout Tool 1/2" to 2" Kit

- Includes:
- (2) M18™ REDLITHIUM™ XC Extended Capacity Battery (48-11-1828)
- (1) M18™ & M12™ Multi-voltage charger (48-59-1812)
- (1) Exact™ 1/2" Stainless steel die (49-16-2660S)
- (1) Exact™ 1/2" Stainless steel punch (49-16-2661S)
- (1) Exact™ 3/4" Die (49-16-2662)
- (1) Exact™ 3/4" Punch (49-16-2663)
- (1) Exact™ 1" Die (49-16-2664)
- (1) Exact™ 1" Punch (49-16-2665)
- (1) Exact™ 1-1/4" Die (49-16-2666)
- (1) Exact™ 1-1/4" Punch (49-16-2667)
- (1) Exact™ 1-1/2" Die (49-16-2668)
- (1) Exact™ 1-1/2" Punch (49-16-2669)
- (1) Exact™ 2" Die (49-16-2670)
- (1) Exact™ 2" Punch (49-16-2671)
- (1) 7/16" Draw Stud (49-16-2680)
- (1) 3/4" Draw Stud (49-16-2681)
- (1) Ball Stud
- (1) Coupler
- (1) Quick connect collar
- (1) Carrying case



Part #	Mfg #	Description	Price
167335	2676-22	FORCELOGIC™ M18™ 10 Ton Knockout Tool 1/2" to 2" Kit	

FORCELOGIC™ M18™ 10 Ton Knockout Tool 1/2" to 4" Kit

- Includes:
- (1) 1-1/8" Draw Stud
- (2) M18™ REDLITHIUM™ XC extended capacity battery (48-11-1828)
- (1) M18™ & M12™ Multi-voltage charger (48-59-1812)
- (1) EXACT™ 1/2" Stainless steel die (49-16-2660S)
- (1) EXACT™ 1/2" Stainless steel punch (49-16-2661S)
- (1) EXACT™ 3/4" Die (49-16-2662)
- (1) EXACT™ 3/4" Punch (49-16-2663)
- (1) EXACT™ 1" Die (49-16-2664)
- (1) EXACT™ 1" Punch (49-16-2665)
- (1) EXACT™ 1-1/4" Die (49-16-2666)
- (1) EXACT™ 1-1/4" Punch (49-16-2667)
- (1) EXACT™ 1-1/2" Die (49-16-2668)
- (1) EXACT™ 2" Die (49-16-2670)
- (1) EXACT™ 2" Punch (49-16-2672)
- (1) EXACT™ 2-1/2" Die (49-16-2672)
- (1) EXACT™ 2-1/2" Punch (49-16-2673)
- (1) EXACT™ 3" Die (49-16-2674)
- (1) EXACT™ 3" Punch (49-16-2675)
- (1) EXACT™ 3-1/2" Die (49-16-2676)
- (1) EXACT™ 3-1/2" Punch (49-16-2677)
- (1) EXACT™ 4" Die (49-16-2678)
- (1) EXACT™ 4" Punch (49-16-2679)
- (1) 7/16" Draw stud (49-16-2680)
- (1) 3/4" Draw stud (49-16-2681)
- (1) Ball stud
- (1) Coupler
- (1) Quick connect collar
- (2) Carrying case



Part #	Mfg #	Description	Price
167336	2676-23	FORCELOGIC™ M18™ 10 Ton Knockout Tool 1/2" to 4" Kit	

Power Tools

M18™ Miscellaneous Tools

M18 FUEL™ 4-1/2"/5" Grinder, Paddle Switch No-Lock Kit

- **POWERSTATE™** Brushless motor: delivers maximum power and up to 10X longer motor life
- **REDLINK PLUS™** Intelligence provides optimized performance, electronic clutch, and overload protection using total system communication between tool, battery, and charger
- **REDLITHIUM™ XC 4.0** Battery pack provides superior pack construction, electronics, and performance to deliver 2X more run-time and more work over pack life
- **Power TO GRIND:** World's first cordless grinder with corded performance
- **DURABILITY:** Same metal housing & gearing system as legendary high performance corded grinders
- **100% tool free:** Make all accessory changes and guard adjustments without a wrench for increased productivity
- **Paddle-switch design:** provides increased comfort and ease-of-use when operating in various positions
- **Includes:**
 - (1) M18 FUEL™ 4-1/2"/5" Grinder, paddle switch no-lock (bare tool) (2780-20)
 - (2) M18™ REDLITHIUM™ XC5.0 Extended capacity battery pack (48-11-1850)
 - (1) M18™ & M12™ Multi-voltage charger (48-59-1812)
 - (1) Carrying case
 - (1) Flange nut
 - (1) Spanner wrench
 - (1) Wheel guard



Part #	Mfg #	Description	Price
162116	2780-20	M18 FUEL™ 4-1/2"/5" Grinder, Paddle, Switch No-Lock (Bare Tool)	
164099	2780-22	M18 FUEL™ 4-1/2"/5" Grinder, Paddle Switch No-Lock Kit	

M18™ Tool Box Style Wet/Dry Vacuum

- On-board accessory and hose storage
- HEPA Rated high efficiency filter
- **Includes:**
 - Wet/dry vacuum
 - Filter assembly
 - Crevice tool
 - Wide utility nozzle
 - Wireless vinyl hose
- Battery and charger not included



Part #	Mfg #	Description	Price
136036	0880-20	2 gal, 18V	

M18™ Compact Vacuum

- High performance motor
- Adapts from handheld to stationary
- 40 CFM
- Removable HEPA filter
- Clear view and easy to empty canister
- Canister volume: 36oz
- Inlet diameter: 1 1/4"
- **Includes:**
 - (1) M18™ Compact vacuum (0882-20)
 - (1) Crevice tool
 - (2) Extension
 - (1) HEPA filter



Part #	Mfg #	Description	Price
228972	0882-20	M18™ Compact Vacuum	

M18™ Cordless 2-Speed Grease Gun Kit

- Industry leading 10,000 PSI max operating pressure
- Industry leading max flow-rate of up to 10oz / minute
- New to world precision through Pre-set grease counter dial
- 48" flexible hose offers greater access to difficult to reach fittings
- Air bleeder valve for quick priming
- M18™ REDLITHIUM™ System
- Lock-on/ Lock-off trigger delivers added user convenience
- **Includes:**
 - (1) M18™ Cordless 2-speed grease gun (2646-20)
 - (1) 48" Flex hose w/spring guard
 - (2) M18™ Compact REDLITHIUM™ battery (48-11-1815)
 - (1) M18™ & M12™ Multi-voltage charger (48-59-1812)
 - (1) High pressure grease coupler
 - (1) Hard carrying case
 - (1) Shoulder strap



Part #	Mfg #	Description	Price
160459	2646-20	M18™ Cordless 2-Speed Grease Gun (Bare Tool)	
160923	2646-22CT	M18™ Cordless 2-Speed Grease Gun Kit	

Power Tools

M18™ Cordless 18g Double Cut Shear

- 360° Tool-free rotating head
- Ergonomic body design
- Variable speed trigger
- Belt clip
- 5-Year warranty



Part #	Mfg #	Description	Price
180620	2635-20	M18™ Cut Shear - Tool Only	

M18™ Jobsite Radio

- Digital AM/FM tuner w/ 10 station presets
- Customizeable EQ (Equalizer)
- 2.1A USB Charger for all portable electronic devices
- 3.5mm Aux In Port for wired playback (cable included)
- Powered by all M18™ Batteries or A/C outlet (battery not included)
- Up to 12hrs run time with an M18™ 5.0Ah battery
- Weather sealed auxillary compartment



Part #	Mfg #	Description	Price
185219	2890-20	M18™ Job Site Radio	

M18™ Job site Radio/Charger

- Built-In charger: Quick, convenient charging of all M18™ batteries
- Exclusive digital Bluetooth® receiver
- USB power port
- Premium speakers and 40-watt amplifier
- Customizable equalizer and 10-station preset
- Reinforced roll cage and metal handles
- Weather-sealed compartment: offers on-board protection for small belongings and a smart phone
- On-board bottle opener
- Includes:
 - (1) M18™ Job site radio/charger (2792-20)
 - (1) 16" Auxiliary input cord
 - (2) AAA batteries



Part #	Mfg #	Description	Price
163377	2792-20	M18™ Job Site Radio/Charger	

M18™ Compact Blower (Bare Tool)

- 3-Speed electronic switch and variable speed trigger allow for versatile clearing power
- Lock-on switch reduces user fatigue
- Extension nozzle clears dust and debris easily from the ground or overhead without having to lean over or stretch
- Universal inflator/deflator for easy set-up and take-down of most inflatable products
- Shock-absorbing polymer and reinforced handle resists drops
- Nozzle made from soft plastic to resist crushing or cracking



Part #	Mfg #	Description	Price
163737	0884-20	M18™ Compact Blower (Bare Tool)	

M18™ Jobsite Fan

- Powerful airflow system: Circulates air over 40 feet
- Provides up to 17 hours of runtime on an REDLITHIUM™ XC5.0 battery
- Adjustable head: 120° adjustable head, and 9 stopping positions, provide best control of airflow direction
- AC adaptor included for extended run-time
- Four keyhole hangers and two hanging holes allow for multiple hanging orientations
- Compatible with all M18™ REDLITHIUM™ batteries



Part #	Mfg #	Description	Price
176814	0886-20	M18™ Jobsite Fan	

Power Tools

M18™ Tool Combo Kits

M18 FUEL™ 2 Tool Combo Kit

- Includes:
- (1) M18 FUEL™ 1/2" Hammer drill/driver (bare tool) (2604-20)
- (1) M18 FUEL™ SAWZALL® reciprocating saw (bare tool) (2720-20)
- (2) M18™ REDLITHIUM™ XC 4.0 Extended capacity battery pack (48-11-1840)
- (1) M18™ & M12™ Multi-voltage charger (48-59-1812)
- (1) Contractor bag
- (1) 6" 10 TPI thin kerf SAWZALL® blade



Part #	Mfg #	Description	Price
166501	2794-22	M18 FUEL™ 2 Tool Combo Kit	

M18™ Cordless 2-Tool Combo Kit with DPM™

- Digital power management protection prevents damage to the tool and battery in abusive situations
- Includes:
- 1/2" Hammer-Drill driver (2602-20)
- 1/4" Hex impact driver (2650-20)
- (2) REDLITHIUM™ High capacity batteries
- 1-Hour charger
- Contractor bag
- 5-Year warranty



Part #	Mfg #	Description	Price
139154	2697-22	18V	

M18™ Cordless LITHIUM-ION 2-Tool Combo Kit

- Includes:
- (1) M18™ Compact 1/2" drill driver (bare tool) (2606-20)
- (1) M18™ 1/4" Hex impact driver (bare tool) (2656-20)
- (2) M18™ Compact REDLITHIUM™ battery (48-11-1815)
- (1) M18™ & M12™ Multi-voltage charger (48-59-1812)
- (1) Contractor bag



Part #	Mfg #	Description	Price
153676	2691-22	M18™ Cordless LITHIUM-ION 2-Tool Combo Kit	

M18™ Cordless LITHIUM-ION 2-Tool Combo Kit

- Includes:
- (1) M18™ Compact 1/2" Hammer drill/driver (bare tool) (2607-20)
- (1) M18™ SAWZALL® Recip saw (bare tool) (2620-20)
- (1) M18™ REDLITHIUM™ XC Extended capacity battery (48-11-1828)
- (1) M18™ & M12™ Multi-Voltage charger (48-59-1812)
- (1) Contractor bag



Part #	Mfg #	Description	Price
155644	2694-22	M18™ Cordless LITHIUM-ION 2-Tool Combo Kit	

M18™ Cordless 4-Tool Combo Kit (1)

- Includes:
- 1/2" Hammer drill driver (2602-20)
- Sawzall® reciprocating saw (2620-20)
- 6-1/2" Circular saw (2630-20)
- Work light (49-24-0171)
- (2) REDLITHIUM™ XC High capacity batteries
- 1-Hour charger
- (1) Sawzall® blade
- Contractor bag



Part #	Mfg #	Description	Price
137564	2694-24	18V	

M18™ Cordless 4-Tool Combo Kit (2)

- Includes:
- M18™ 1/2" Hammer drill driver (2602-20)
- M18™ HACKZALL® Reciprocating saw (2625-20)
- M18™ 1/4" Hex Impact driver (2650-20)
- M18™ Work light (49-24-0171)
- (2) M18™ REDLITHIUM™ XC High capacity batteries (48-11-1828)
- 1-Hour charger (48-59-1801)
- General purpose Sawzall® blade
- Contractor bag



Part #	Mfg #	Description	Price
138971	2695-24	18V	

Power Tools

M18™ Cordless 4-Tool Combo Kit (3)

- Includes:
 - 1/2" Hammer drill driver (2602-20)
 - 1/4" Hex impact driver (2650-20)
 - Sawzall® M18™ reciprocating saw (2620-20)
 - Work light (49-24-0171)
 - (2) REDLITHIUM™ XC High capacity batteries
 - 1-Hour charger
 - General purpose Sawzall® blade
 - Contractor bag



Part #	Mfg #	Description	Price
138527	2696-24	18V	

M18 FUEL™ LITHIUM-ION 4-Tool Combo Kit

- Includes:
 - (1) M18 FUEL™ 1/2" Hammer Drill/Driver (bare tool) (2604-20)
 - (1) M18 FUEL™ 1/4" Hex impact driver (bare tool) (2653-20)
 - (1) M18 FUEL™ SAWZALL® Reciprocating saw (bare tool) (2720-20)
 - (1) M18™ LED Work light (2735-20)
 - (1) M18™ REDLITHIUM™ XC 4.0 Extended capacity battery pack (48-11-1840)
 - (1) M18™ & M12™ Multi-voltage charger (48-59-1812)
 - (1) Belt clip
 - (1) Contractor bag
 - (1) Reciprocating blade



Part #	Mfg #	Description	Price
164933	2796-24	M18 FUEL™ LITHIUM-ION 4-Tool Combo Kit	

M18 FUEL™ LITHIUM-ION 6-Tool Combo Kit

- Includes:
 - (1) M18 FUEL™ 1/2" Hammer Drill/Driver (bare tool) (2604-20)
 - (1) M18 FUEL™ 1/4" Hex impact driver (bare tool) (2653-20)
 - (1) M18 FUEL™ SAWZALL® Reciprocating saw (bare tool) (2720-20)
 - (1) M18 FUEL™ 6-1/2" Circular saw (bare tool) (2730-20)
 - (1) M18™ LED work light (2735-20)
 - (1) M18 FUEL™ 4-1/2"/5" Grinder, paddle switch no-lock (bare tool) (2780-20)
 - (2) M18™ REDLITHIUM™ XC 4.0 Extended capacity battery pack (48-11-1840)
 - (1) M18™ & M12™ Multi-voltage charger (48-59-1812)
 - (1) Belt clip
 - (1) Circular saw blade
 - (2) Contractor bag
 - (1) Reciprocating blade
 - (1) Spanner wrench



Part #	Mfg #	Description	Price
164934	2796-26	M18 FUEL™ LITHIUM-ION 6-Tool Combo Kit	

M18™ Cordless LITHIUM-ION 9-Tool Combo Kit

- Includes:
 - (1) M18™ Cordless 1/2" hammer drill/driver (2602-20)
 - (1) M18™ Cordless right angle drill (2615-20)
 - (1) M18™ SAWZALL® Recip saw (2620-20)
 - (1) M18™ Cordless LITHIUM-ION 6 -1/2" circular saw (2630-20)
 - (1) M18™ Cordless LITHIUM-ION jig saw (2645-20)
 - (1) M18™ 1/4" Hex compact impact driver (2650-20)
 - (1) M18™ 1/2" High-torque impact wrench with friction ring (2663-20)
 - (1) M18™ Cordless LITHIUM-ION 4-1/2" cut-off/grinder (2680-20)
 - (2) M18™ REDLITHIUM™ XC Extended capacity battery (48-11-1828)
 - (1) M18™ & M12™ Multi-voltage charger (48-59-1812)
 - (1) M18™ Work light (49-24-0171)



Part #	Mfg #	Description	Price
156090	2696-29	M18™ Cordless LITHIUM-ION 9-Tool Combo Kit	

Power Tools

Drills

3/8" Pistol Drill

- 8 Amp motor
- 120VAC Only
- Keyless, metal chuck type
- All metal gear case
- Soft grip handle and 2-finger trigger
- 8' Cord
- Includes:
 - 3/8" Drill
 - Side handle



Part #	Mfg #	No Load RPM	Price
139060	0240-20	0 - 2,800	

5/8" SDS Plus Rotary Hammer Kit

- Powerful 5.5 amp motor: Delivers 0-3,700 RPM, 0-4 400 BPM and 1.5 ft-lbs of torque, providing up to 65% faster drilling speeds
- Lightweight 4.6-lb design: Reduces fatigue when you drill overhead and in horizontal applications
- Compact 10.9" profile: Lets you work more efficiently in tight spaces
- 2-Mode operation: Choose rotary hammer or rotation only for added versatility
- AVS Anti-Vibration System: Minimizes vibration for maximum comfort
- Mechanical clutch: Protects the motor when the bit binds



Part #	Mfg #	Description	Price
164855	5263-21	5/8" SDS Plus Rotary Hammer Kit	

1-9/16" Spline Rotary Hammer

- Powerful 10.5 amp motor: Delivers 450RPM and 3,000 BPM
- Powerful hammer mechanism: Delivers 5.5 ft-lbs of impact energy for drilling in hard aggregate
- CPT™- Constant power technology: Delivers consistent performance in tough applications
- Mechanical clutch: Protects the tool when the bit binds up
- 2-Mode operation: Rotary hammer and hammer only for maximum versatility
- 12-Position chipping adjustment: Allows the user to maintain the desired hammer position while chipping in any orientation



Part #	Mfg #	Description	Price
153749	5316-21	1-9/16" Spline Rotary Hammer	

1-9/16" SDS Max Rotary Hammer

- Powerful 10.5 Amp motor: Delivers 450 RPM and 3,000BPM
- Powerful hammer mechanism: Delivers 5.5 ft-lbs of impact energy for drilling in hard aggregate
- CPT™- Constant power technology: Deliver consistent performance in tough applications
- Mechanical clutch: Protects the tool when the bit binds up
- 2-mode operation: Rotary hammer and hammer only for maximum versatility
- 12-Position chipping adjustment: Allows the user to maintain the desired hammer position while chipping in any orientation



Part #	Mfg #	Description	Price
159786	5317-21	1-9/16" SDS Max Rotary Hammer	

Power Tools

1/2" Hole Hawg® Drill 900 RPM

- Powerful 7.5-amp motor: Delivers 900 RPM with reverse
- Selffeed bit capacity: Handles up to a 2-9/16"
- Reinforced nylon resin casing: Provides durability and a reduced weight with greater heat dissipation and resistance to chemicals
- Includes:
 - (1) 1/2" Hole Hawg® Drill 900RPM (1670-1)
 - (1) Pipe handle



Part #	Mfg #	Description	Price
224919	1670-1	1/2" Hole Hawg® Drill 900 RPM	

3/4" Large Drill, 350 RPM

- Powerful 10.0-amp motor. Delivers up to 350RPM with reverse
- Torque: Offers 3/4" capacity in steel
- Heat-treated gears: Helical-cut for quiet performance
- 8-ft fixed rubber cord: Durable construction
- Includes:
 - (1) 3/4" Large Drill (1854-1)
 - (1) Pipe Handle



Part #	Mfg #	Description	Price
151479	1854-1	1854-1 3/4" 120V 350RP Drill	

1/2" Magnum® Drill

- Motor: 120VAC 8A
- 360° Locking side handle
- Chuck key with holder
- 8' Cord



Part #	Mfg #	No Load RPM	Price
139067	0299-20	0 - 850	
184121	0300-20	1/2" Magnum® Drill, 0-850 RPM	

Right Angle Drill Kits

1/2" Reversing Right Angle Drill Kit

- 120VAC, 7.0A R.A.D.
- 1/2" Trigger speed control reversing
- All ball and roller bearings
- Helical cut, heat treated gears
- Durable, glass reinforced nylon handles
- Use with up to 4-5/8" self-feed bits
- Steel hardened shafts
- Head and handle swivel 360°
- Locks tight in any position
- Allow 5-1/2" for right angle drill head and chuck
- Quadruple gear train
- Includes:
 - Chuck key and rubber flex key holder
 - Right angle drive
 - 9/16" Open end wrench
 - 3/16" Socket wrench
 - Chuck remover bar
 - Side handle
 - Steel carrying case
 - 8' 3-Wire Quik-Lok® cord set



Part #	Mfg #	Kit Type	Drill RPM	Amps	Price
137799	3107-6	Variable	0-500	7.0	

Super Hawg™ Drills

M18™ FUEL™ Super Hawg™ 1/2" Right Angle Drill Kit

- POWERSTATE™ brushless motor
- REDLINK™ PLUS intelligence ensures optimal performance and overload protection
- Includes:
 - M18™ FUEL™ 1/2" Right Angle Drill
 - M18™ REDLITHIUM™ battery pack
 - M18™&M12™ rapid charger
 - Chuck key
 - Side handle
 - Contractor bag
- 5-Year warranty



Part #	Mfg #	Description	Price
181107	2709-22	M18™ FUEL™ Supwer Hawg Kit	

Power Tools

Super Hawg™ 1/2" Drill

- Clutch in low speed
- High operating speeds for maximum productivity
- 90° Left-right, Roto-Lok® handle
- Comfort grip switch handle and gear case with front T-bar handle
- Includes side handle
- 1680-21 Includes carrying case
- 5-Year warranty



Part #	Mfg #	No Load RPM	Steel Capacity	Price
148643	1680-20	450/1,750	1/2"	
137572	1680-21	450/1,750	1/2"	

Hole-Hawg® Hole-Hawg® Drill

- 120VAC, 7.5A
- Compact design for drilling between studs and joists
- Heat treated gears
- All ball and roller bearings
- Triple reduction gearing
- 2-Position pipe handle
- 3-Position spade handle
- 2-Speed gear shift
- External brush caps
- Includes steel carrying case



Part #	Mfg #	No Load RPM	Price
144516	1676-6	300/1,200	

Circular Saws

TILT-LOK™ 7-1/4" Circular Saw with Case

- New exclusive TILT-LOK™ main handle adjusts to the work or most comfortable work position
- 10.4 pounds net weight
- 15 amp, 3.25 peak horsepower
- Wide, clear sight line
- Includes:
 - (1) TILT-LOK™ 7-1/4" Circular Saw with case (6390-21)
 - (1) Blade wrench
 - (1) Carrying case
 - (1) Circular saw blade



Part #	Mfg #	Description	Price
154578	6390-21	TILT-LOK™ 7-1/4" Circular Saw with Case	

8" Metal Cutting Saw Kit

- Dry-cut technology provides faster, cleaner, more affordable metal cutting
- Durable blade shields with integral chiptank deflects/collects hot chips and sparks
- Plunge lever for fast, effective plunge cuts
- Exclusive quick-release shield latch for fast waste disposal and blade changes
- 2-9/16 in cut depth for one-pass cuts through most common materials
- Powerful 13.0 amp, 3,700 rpm motor
- Premium cermet-tipped blades cut faster, cleaner, and longer than other carbide-tipped or friction blades



Part #	Mfg #	Description	Price
161013	6370-21	8" Metal Cutting Saw Kit	

Sawzall® Reciprocating Saws

13 Amp Orbital Super Sawzall® with Case

- Orbital cutting action
- Variable speed trigger
- Quik-Lok™ blade clamp
- 8' Cord
- 5-Year warranty



Part #	Mfg #	Length of Stroke	Strokes Per Minute	Price
148168	6536-21	1-1/4"	0 - 3,000	

Power Tools

12 Amp Sawzall® Reciprocating Saw

- Quik-Lok™ blade clamp
- Gear protecting clutch
- Counter weighted mechanism
- Includes:
 - (1) Sawzall® blade
 - Carrying case
- 5-Year warranty



Part #	Mfg #	Length of Stroke	Strokes Per Minute	Price
137571	6509-31	3/4"	0 - 3,000	

360° Rotating Handle Orbital Super Sawzall® Recip Saw

- 360° Rotating handle
- 13 Amp Milwaukee built motor
- Orbital cutting action
- Variable speed trigger, 0-3000 SPM
- 1-1/4in stroke
- Counter balanced/gear protection systems
- Speed dial
- QUIK-LOK™ blade clamp
- QUIK-LOK® cord
- Includes:
 - (1) 360° Rotating handle orbital super Sawzall® recip saw (6523-21)
 - (1) Carrying case



Part #	Mfg #	Description	Price
154278	6523-21	360° Rotating Handle Orbital Super Sawzall® Recip Saw	

Band Saws

Compact Band Saw

- 120VAC
- 7.0A Motor, 3-wire, 8' cord
- LED Work light
- Blade ejection system
- Drop-resistant pulley guard
- Cast aluminum gear case
- Adjustable material guide
- Maximum rectangular capacity: 3-1/4" x 3-1/4"
- Maximum round capacity: 3-1/4"
- Includes:
 - Band saw
 - Case
- 5-Year warranty



Part #	Mfg #	No Load SFPM	Price
142295	6242-6	200 - 300	

Abrasive Cut-Off Machines

14" Abrasive Cut-Off Machine

- Cuts up to 5" pipe
- Oversized wheel guards
- Miter capacity: 45° with adjustable fence
- Large spindle lock button
- Includes:
 - Vise
 - Abrasive wheel
 - Hex wrench
- 5-Year warranty



Part #	Mfg #	Description	Price
142284	6177-20	120VAC/DC, 15 Amps	

Power Tools

14" Hand Held Cut-Off Machine

- Powerful 15-amp, 4.8 maximum horsepower motor: Delivers maximum cutting performance for heavy-duty concrete and metal cutting
- 20-amp overload protection switch: Trips the tool, not a remote breaker, for greater convenience and minimal downtime
- Downward cutting rotation: Pulls the tool through the work to minimize jamming and kickback while providing a clear sight-line
- Externally accessible brushes and brush cutoff feature: Protect the epoxy-coated armature as the brushes wear down



Part #	Mfg #	Description	Price
161844	6185-20	14" Hand Held Cut-off Machine	

Sanders

5" Random Orbit Palm Sander

- 3.0A Motor
- Permanent magnet motor
- Variable speed dial
- Integrated Vacuum ports: 1-1/4" & 2-1/4"
- Includes:
 - Carrying case
 - Dust bag
 - PSA Pad
 - Hook and loop pad
 - (2) Sheets 80 grit 8-hole sandpaper



Part #	Mfg #	Speed RPM	Disc Dia	Price
139047	6021-21	12,000	5"	

Grinders

11 AMP 4-1/2" Small Angle Grinder Paddle, Lock-On

- Powerful 11 AMP, 11,000 RPM motor
- Overload Protection
- Electronic Clutch
- Tool-Free accessory change
- Tool-Free adjustable guard
- Advanced airflow system
- Debris baffles
- Includes:
 - (1) 11 Amp 4-1/2" small angle grinder paddle, lock-on (6146-30)
 - (1) Contractor bag
 - (1) Flange
 - (1) Grinding wheel
 - (1) Side handle
 - (1) Spanner wrench
 - (1) Type 27 guard



Part #	Mfg #	Description	Price
158930	6146-30	11 Amp 4-1/2" Small Angle Grinder Paddle, Lock-On	

Misc. Tools

1-Stage Wet/Dry Vacuum Cleaner

- 10 gal, 1-1/8 bu. recovery capacity, 8.0 amp motor
- Positive water shut-off
- Can be used as a blower
- One-stage bypass motor for wet/dry operation



Part #	Mfg #	Description	Price
176821	8955	1-Stage Wet/Dry Vacuum Cleaner	

Power Tools

14 Gauge Shear

- 5 amps, 4,000 SPM
- Clear unobstructed visibility
- Cuts close curves either left or right
- Blade design eliminates jamming



Part #	Mfg #	Description	Price
176044	6815	14 Gauge Shear	

10 Gauge Nibbler

- 4.0 amp, 1,000 SPM
- Cuts up to 8.75ft per minute
- 1.65 in. starting hole required
- AC-DC toggle switch allows for two-handed operation



Part #	Mfg #	Description	Price
176046	6880	10 Gauge Nibbler	

Temperature Guns

Infrared Laser TEMP-GUN™ Thermometer Kit

- Basic accuracy: 1.50%
- Distance to spot: 12 to 1
- Includes:
 - Laser TEMP-GUN™ thermometer
 - (3) AA Alkaline batteries
 - K-Type thermocouple
 - Slide rail system
- 5-Year warranty



Part #	Mfg #	Temperature Range	Price
137568	2266-20	-20° to 932°F	

Heat Guns

Dual Temperature Heat Gun

- Dual temperature 570 and 1000 degrees F, 11.6 amp motor
- Unique impact resistant heating element
- Three position rock switch - off, high and low



Part #	Mfg #	Description	Price
161906	8975-6	Dual Temperature Heat Gun	

Cordless Batteries and Accessories

12V Lithium-Ion Battery

- Over 65% lighter than "compact" NiCd batteries
- For use with Milwaukee® 12V cordless tools
- 2-Year warranty



Part #	Mfg #	Description	Price
137574	48-11-2401	12V Lithium-Ion Battery	

M12 REDLITHIUM™ Compact Battery Two Pack

- 1.5 Amp hour
- Lightweight - Over 65% lighter vs "compact NiCd batteries"
- Compact - Over 50% smaller vs "compact NiCd batteries"
- LITHIUM-ION battery delivers long life and run time with fade-free power
- Battery fuel gauge displays charge status on tool
- For use with Milwaukee M12 cordless tools



Part #	Mfg #	Description	Price
154721	48-11-2411	M12 REDLITHIUM™ Compact Battery Two Pack	

M12 REDLITHIUM™ XC Battery Two Pack

- 3.0 Amp hour
- High current discharge
- Sturdy base- Allows M12™ tools to easily stand
- LITHIUM-ION battery delivers long life and run time with fade-free power
- Battery fuel gauge displays charge status on tools
- M12™ Compatibility



Part #	Mfg #	Description	Price
171802	48-11-2412	M12 REDLITHIUM™ XC Battery Two Pack	

M18™ REDLITHIUM™ 2.0 Compact Battery Pack

- REDLINK™ Intelligence
- Best-in-class construction
- Fuel gauge onboard
- All-weather performance



Part #	Mfg #	Description	Price
154722	48-11-1820	M18™ REDLITHIUM™ 2.0 Compact Battery Pack	

Power Tools

M18™ REDLITHIUM™ XC 4.0 Extended Capacity Battery Pack

- REDLINK™ Intelligence
- Best-in-class construction
- Fuel gauge onboard
- All-weather performance
- Versatility: Powers more than 40 Milwaukee M18™ cordless power tools



Part #	Mfg #	Description	Price
158199	48-11-1840	M18™ REDLITHIUM XC 4.0 Extended Capacity Battery Pack	

M18™ REDLITHIUM™ XC5.0 Extended Capacity Battery Pack

- REDLINK™ Intelligence: Provides optimized performance and overload protection using total system communication between tool, battery and charger
- Best-in-class construction
- Fuel gauge onboard
- All-weather performance
- Versatility- Powers more than 60 Milwaukee® M18™ cordless power tools



Part #	Mfg #	Description	Price
173430	48-11-1850	M18™ REDLITHIUM™ XC5.0 Extended Capacity Battery Pack	

M18 REDLITHIUM™ High Capacity Battery Two Pack

- 3.0 Amp hour
- LITHIUM-ION battery delivers long life and run time with fade-free
- Battery fuel gauge
- Overload protection
- Temperature management system
- Individual cell monitoring
- Discharge protection
- Best in class construction
- Integrated weld frame
- Cell separator
- Impact and vibration protective rubber



Part #	Mfg #	Description	Price
154296	48-11-1822	M18 REDLITHIUM™ High Capacity Battery Two Pack	

18V Ni-Cd Battery

- Works with all 18V NiCd and V18 tools excluding:
 - 1108
 - 3108
 - 5364
 - 6516



Part #	Mfg #	Description	Price
139148	48-11-2230	Easy Release Latch	

28V Lithium-Ion Battery

- Overload protection
- Temperature management system
- Individual cell voltage monitoring
- Discharge protection
- Battery fuel gauge
- 3-Year warranty



Part #	Mfg #	Description	Price
142696	48-11-2830	28V Lithium-Ion Battery	

M12™ Power Source

- 2.1 amp powered USB port charges all portable electronic devices, including tablets
- On-board fuel gauge
- Compatible with all M12™ battery packs
- Compatible with all M12™ heated gear



Part #	Mfg #	Description	Price
161648	49-24-2310	M12™ Power Source	

M12™ Lithium-Ion Battery Charger

- 30-Minute charge time
- 5-Year warranty



Part #	Mfg #	Description	Price
137575	48-59-2401	12V Lithium-Ion Battery Charger	

Power Tools

M12™ Four Bay Sequential Charger

- Accepts up to 4 M12™ Battery Packs
- Sequentially charges batteries
- Compact design with wall mount
- REDLINK™ Intelligence: charger communication with the battery pack to ensure optimum performance and extend life



Part #	Mfg #	Description	Price
173929	48-59-1204	M12™ Four Bay Sequential Charger	

M28™ 3-Bay Universal Charger

- Single-unit simplicity: Milwaukee M28™ lithium-ion, V18 Lithium-ion and NiCd batteries
- Durable construction: Withstands tough job site conditions
- 9-ft. Pass-through plug
- High-visibility LED light: Displays charge status from across the room



Part #	Mfg #	Description	Price
164783	48-59-0280	M28™ 3-Bay Universal Charger	

M18™ Six Pack Sequential Charger

- Charges up to six batteries sequentially
- Convenient carrying handle
- Pass through plug
- Compact size



Part #	Mfg #	Description	Price
148534	48-59-1806	M18™ Six Pack Sequential Charger	

M18™ and M12™ Multi-Voltage Battery Charger

- 12V and 18V
- 5-Year warranty



Part #	Mfg #	Description	Price
148692	48-59-1812	M18™ and M12™ Battery Charger	

M18™ Lithium-Ion AC/DC Wall & Vehicle Charger

- AC Wall charger and DC vehicle charger
- Charges all M18™ batteries
- Charge times:
 - 48-11-1815: 30-Minute
 - 48-11-1828: 1-Hour
 - 48-11-1820: 45-Minute
 - 48-11-1840: 90-Minute



Part #	Mfg #	Description	Price
138273	2710-20	18V	

Cut-Off Machine Accessories

.045" x 7/8" Cut-Off Wheel

- For general purpose to specialized high performance applications
- Consistent performance from wheel to wheel
- Tested for balance, resulting in smooth, vibration free grinding and cutting



Part #	Mfg #	Size	Type	Price
138407	49-94-4500	4-1/2"	1	
162159	49-94-4520	4-1/2"	1/4"	

3/32" x 1" Cut-Off Wheel

- For general purpose to specialized high performance applications
- Consistent performance from wheel to wheel
- Tested for balance, resulting in smooth, vibration free grinding and cutting

Part #	Mfg #	Size	Type	Price
140073	49-94-1405	14"	1	

Milwaukee® Parts

Bit Holder

Part #	Mfg #	Description	Price
150713	43-72-0550	Bit Holder	

Screws, Nuts & Bolts

Part #	Mfg #	Description	Price
150710	06-82-5275	6-32" x 5/16" Torx Head Screw	

Power Tools

Pipe Inspecting and Locating
SeeSnake® micro™ Inspection Camera

- Allows you to easily perform visual inspections in hard to reach areas
- Lightweight, hand-held design can be carried anywhere
- 3' Cable reach expandable to 30' with optional extensions
- Includes batteries, mirror, hook and magnet



Part #	Mfg #	Display	Diameter	Lighting	Power Source	Price
141173	36738	3.5" Color LCD	17mm	(4) Adj LEDs	(4) AA Batteries	

Refrigeration Tools

Refrigerant Piping and Components

Rotary Vane Deep Vacuum Pump

- Internal check valve stops oil blowout in case of accidental power loss
- Gas ballast valve helps prevent oil contamination caused by high moisture
- Manifold valve isolates pump from system when testing for leaks
- Center oil fill port is accessible from front & sides
- Durable light weight die cast aluminum housing
- Delrin vanes for quieter, longer-lasting performance
- 2-Stage for lower pumping pressure
- Oil drain valve at bottom of oil reservoir
- 25 Microns ultimate vacuum
- Electrical Specs: 120V/60Hz (2-Stage_



Part #	Mfg #	Free Air Displace	Motor	Nom Pump Speed	Price
150637	90066-2V-110	6 CFM	1/3 hp	3440 rpm	

ACCU-Charge II Electronic Refrigerant Scale

- Functions:
 - Charge programming
 - Pause/charge
 - Tank capacity programming (empty/full)
 - Repeat
- Capacity: 240 lbs
- Auto off: 3 hours
- Operating temperature: 32° to 120°F
- Battery life approximately 40 hours (9 VDC)



Part #	Mfg #	Description	Price
140934	98210-A	9" x 9" Platform	

Pro-Set® Cyclone Refrigerant Recovery Machine

- Fastest overall ARI certified recovery rates in its class in all temperature environments
- Automatic low pressure shut-off feature turns unit off when recovery is completed
- Rugged high density double walled plastic housing with easy view top mounted controls
- R-410A Ready with 550 psi high pressure shut-off switch
- Ergonomic well balanced design for easy transport including shoulder strap, weighs 36 lbs
- Built-in suction filter located under suction port



Part #	Mfg #	Description	Price
112428	87-CR700	1 hp Oil-Less Cyclone	

Tools

Refrigeration Tools

Electronic Digital Vacuum Gauge

- Large 5 digit LCD display
- Measurement units are selectable for microns, in/hg, mBar, Torr. Advanced field
- Cleanable sensor can withstand 400 psi positive pressure
- Operates 30 hours on standard 9V alkaline battery



Part #	Mfg #	Description	Price
113610	87-VG200	Digital Gauge, Carry Hook, Tee, 9V Battery & Case	

Brass Access Tee - Sweat

- One valve core included for each tee
- All male flare fittings are internally threaded to accept installation of valve core
- Includes brass cap for use with core wrench



Part #	Mfg #	Fitting 1	Fitting 2	Branch Fitting	Body	Price
092124	83-CC8414-2PK	1/4" Sweat ODF	1/4" Sweat ODF	1/4" SAE Flare	Copper	
080959	83-CC8438-2PK	3/8" Sweat ODF	3/8" Sweat ODF	1/4" SAE Flare	Copper	
080956	83-CC8412-2PK	1/2" Sweat ODF	1/2" Sweat ODF	1/4" SAE Flare	Copper	

Brass Access Tee - Threaded

- One valve core included for each tee
- All male flare fittings are internally threaded to accept installation of valve core



Part #	Mfg #	Fitting 1	Fitting 2	Branch Fitting	Body	Price
103852	83-CD9601-2PK	1/4" SAE Flare (F)	1/4" SAE Flare (M)	1/4" SAE Flare (M)	Copper	

Valves

Pro-Set® Ball Valve

- Add existing hose to eliminate refrigerant loss to comply with EPA regulations
- 1/4-Turn operation, color-coded handles



Part #	Mfg #	Description	Price
119736	87-BV3-3PK	1/4" Female, 1/4" Male, SAE, 3/Pk	

Microseal™ Anti-Blowback Valve

- Automated sealing eliminates refrigerant loss and blowback
- Non-restrictive porting for maximum refrigerant flow
- SAE Male x SAE Female



Part #	Mfg #	Description	Price
098447	87-AB3-3PK	1/4" Female, 1/4" Male, SAE, 3/Pk	

Tools

Refrigeration Tools

Valve Core



Part #	Mfg #	Description	Price
140745	83-CD4460-6PK	Valve Core, 6/Pk	

Refrigerant Wrenches

6-in-1 Metric Torque Wrench

- Ideal for installing mini-split systems
- Includes (6) interchangeable heads: 12, 22, 24, 26, 27 & 29mm jaw sizes



Part #	Mfg #	Description	Price
150265	TLTWSM	Metric 6-in-1 Metric Torque Wrench	

Chemicals

Acid Test Kit

- Use to determine the acid level in mineral and alkybenzene lubricants typically used with HCFC refrigerants such as R-22 and R-401A (not for use with POE oil)
- One test per kit
- Easy to use, no complicated charts, results in seconds
- Simply add oil, shake, and observe color change (turns yellow if acidic)



Part #	Mfg #	Description	Price
031600	85-25140-01	Ref Oil Acid Test Kit	

Tools

Refrigeration Tools

Refrigeration Oil Test Kits

Phase III® Refrigeration Oil Test Kit

- For use on POE's, minerals oils, and alkylbenzene
- Tests acid level in refrigeration oil



Part #	Mfg #	Description	Price
140753	4320-W8	Phase III Oil Test Kit	

Refrigeration Tools

Charging Hoses

- Strong 6-sided crimp
- Coupler nuts are deeply knurled
- Fittings are 1/4" FFL x 1/4" FFL

1/4" Enviro-Guard™ Hose with Ball Valve

- In-line ball valves control refrigerant flow, open and close in 1/4-turn



Part #	Mfg #	Description	Price
028021	65060	(3) 60" Envir-Guard Hose Set	

Flexible Adapter

- Brass fittings
- Durable 6" long neoprene coated hose



Part #	Mfg #	Description	Price
064120	40083	1/4" Hose Gaskets	



Refrigeration Tools

Refrigerant Parts

Gasket

Part #	Mfg #	Description	Price
144859	87-HXG	Hose Gasket, 10/Pack, Fits 1/4"SAE, 1/2" Acme or 1/2" 20 UNF	

Hose - Refrigerant

Part #	Mfg #	Description	Price
140755	40360	5' Blue, Red, Yellow Refrigerant Hose Set	
140756	41601	5' Blue Refrigerant Hose	
140757	41602	5' Yellow Refrigerant Hose	
126840	41603	5' Red Refrigerant Hose	
096037	45360	5' Blue, Red, & Yellow Refrigerant Hose Set with Anti-Blowback Fittings	
148224	87-HP5BA	5' Blue Refrigerant Hose with Anti-Blowback Fittings	
148223	87-HP5RA	5' Red Refrigerant Hose with Anti-Blowback Fittings	
148222	87-HP5YA	5' Yellow Refrigerant Hose with Anti-Blowback Fittings	
148221	87-HS3A	3' Refrigerant Hose Set with Anti-Blowback Fittings	

Manifold

Part #	Mfg #	Description	Price
132142	57161	Aluminum 2-Way Manifold Gauge Set with 5' Hoses	
105054	87-MBHP5	Manifold with Hose(R-410A-R22)	

Vacuum Pump Oil

Part #	Mfg #	Description	Price
148101	85-2600	1 qt	
092114	85-2601	1 gal	

Tools, Gauges & Solder

Injector

Part #	Mfg #	Description	Price
097336	87-INJ001	System Injector	

Valve Core Tool

Part #	Mfg #	Description	Price
104588	91490	Protech Universal Valve Core Tool	
140984	91496	Valve Core Remover	
140743	83-CD3813-1PK	Valve Core Container/Wrench	
104515	83-CD3800-1PK	Valve Core Wrench	

Refrigeration Tools

Manifolds

4-Valve Aluminum Manifold

- Forged aluminum body
- Replaceable ss valve seats
- SAE styel o-ring
- Large sight glass
- 3/8" bore throughout
- Comfort grip
- Glows in the dark
- R22-404A-410A



Part #	Mfg #	Description	Price
167725	1839130	60" Hoses, Low Loss Ball-Valve Adapters	

4-Valve Aluminum Manifold Set

- Forged aluminum body
- Replaceable ss valve seats
- SAE styel o-ring
- Large sight glass
- 3/8" bore throughout
- Comfort grip
- Includes:
 - Valve
 - Dual Readout Thermometer
 - 60" Refrigeration hoses w/ ball valve adapters
- R22-404A-410A



Part #	Mfg #	Description	Price
168342	1839131	60" Hoses, Ball-Valve Adapters	

2-Valve Aluminum Manifold

- Forged aluminum body
- Replaceable ss valve seats
- SAE style o-ring
- Large sight glass
- Comfort grip
- Glows in the dark
- Built-in pressure reminder



Part #	Mfg #	Description	Price
166823	1839134	-30" Hg to 300 - 500 psi	

Flaring Tools

Orbital Flare

- Off-center mounted cone spins on an axis to effectively produce quality flares
- Clutch mechanism stops the flaring when the job is done
- Spring-loaded block grips tube securely
- A tube-stop arrow slides to set correct height and positioning, while ball detents allow for easy flaring cone alignment
- Tube Sizes (O.D.) - 3/16", 1/4", 5/16", 3/8", 1/2", 5/8", 3/4"



Part #	Mfg #	Description	Price
167767	1838952	45° Flare Type	

Swaging Tools

Compact Swage Tool

- The power to swage 1-5/8" tubing and the control to swage 5/16" without splitting the tube
- Compact design
- One-handed operation



Kit Includes: 3/8", 1/2", 5/8", 3/4", 7/8", expander heads, body, deburrer, kit box

Part #	Mfg #	Description	Price
165773	1839015	Tube sizes (O.D.) 3/8", 1/2", 5/8", 3/4", 7/8"	

Electronic Tools

Dual Readout Thermometer

- Manifold-compatible compact thermometer
- Use it on any gauge set, or remove it and use it independently
- Two easy-to-use, K-style tube clamp thermocouples



Part #	Mfg #	Description	Price
167727	1839106	0° C to +50°C	

Tools

Refrigeration Tools

Service Tools

Deburrers

- *Steel blades*



Part #	Mfg #	Description	Price
168257	1891258	1/4" to 1-5/8"	

Hoses

Refrigeration Hoses

- *Extra abrasion-resistant layer*
- *Rated for 800 PSI working pressure*
- *60" Length*



Part #	Mfg #	Description	Price
168252	1839153	Set of 3 (Red, Blue, Yellow)	

Refrigeration Tools

Vacuum Gauges

Gas Test Pressure Gauge Assembly (with Clamshell)

- 2" diameter steel case



Part #	Mfg #	Gas Test Fitting	Conn.	Price
183408	355-05PK2	Air Valve Only	3/4" FIP	

Tools

Rulers & Tape Measures

Power Return Tapes

- *Ultraviolet curing extends blade life*
- *Impact-resistant cases*

Magnetic Tip Tape Measure

- *Reinforced end hook*
- *Nylon coated blade*
- *Yellow blade*



Part #	Mfg #	Size	Price
080609	T425M	1" x 25'	



Rulers & Tape Measures

Tape Measures

Part #	Description	Price
035970	1" x 25' Plumb Tape Measure	

Tools

Rulers & Tape Measures

Steel Tapes

Power Return Tape - Double-Sided

- Baked-on epoxy coating to resist scratches, rust, and abrasions
- Thick rubber grip; blue case
- Oversized bold black number on first 11"
16" & 19" Red stud marks



Part #	Mfg #	Length	Width	Price
135034	908-25	25'	1"	

Magnetic Double End-Hook Tape

- Nylon-coated hardened steel blade
- Built-in shock absorber to protect blade tip
- True zero feature for accurate inside and outside measuring
- Durable steel belt clip for convenience
- Multi-riveted end hook with bottom blade protector reinforces the blade tip and provides maximum pull-out strength
- Rare earth magnetic double end hook
- First 11" (279mm) has oversized, bold numbers
- Easy-read fractional scale
- Double-sided rule for measurement while using against wall, ceiling or conduit
- Horizontal and vertical standout for easy one person measurements
- Shock and impact resistant case



Part #	Mfg #	Description	Price
145377	93225	25' With Magnetic Tip	

Folding Wood Rules

Standard Rule

- 6' Long hardwood rules with clear abrasion resistant coating
- Black markings on yellow, with red stud center markings every 16 inches
- Measurements are marked on both sides and both edges, graduated to 1/16th inch
- Engraved graduations on both sides



Part #	Mfg #	Reading	Length	Price
112668	900-6	Inside	6'	

Tools

Rulers & Tape Measures

Rulers

Fiberglass Folding Ruler

- Precision made of flexible heavy-duty fiberglass
- With embedded easy-to-read boldface figures and graduations with red 16" stud marks and positive locking joints
- 6" Inside flat reading



Part #	Mfg #	Model	Width	Length	Price
008692	73370	1619F	5/8"	6'	

Tools

Saws & Blades

Hand Hacksaw Frames
HT50 High Tension Frame

- Unique I-beam construction
- Rubberized handle
- 50,000 psi
- Handle stores up to (5) extra blades
- Frame includes (1) 12" 24 TPI blade



Part #	Mfg #	Description	Price
129562	12132-HT50	High Tension Metal Cutting	

Hand Saws
Compact Hacksaw

- Heavy-duty aluminum handle
- Allows for flush cutting applications



Part #	Mfg #	Description	Price
006368	20975-975	Multi-Purpose	

Close Quarter® Saw

- Reaches into tight spaces where standard won't fit



Part #	Mfg #	Description	Price
006366	20908-908	Close Quarter Saw	
022382	20906-906	6"L x 1/4"W, 32 TPI Blade	

Tri-Fold® Saw

- Complete with reciprocating blade
- Locks into three different positions for cutting anything from wood to drywall, to stainless steel at any angle
- Uses any reciprocating blade with 1/2" tang



Part #	Mfg #	Description	Price
113553	20997-TFHS618	(2) Blade, Plaster, Wood, & Metal Cutting (635R/636RP) 636	

PVC/ABS Plastic Pipe Hand Saw

- Wide rigid carbon steel blade with hardened teeth
- Cut any size diameter plastic pipe, wood and nail-embedded wood
- Heavy-duty lightweight aluminum handle

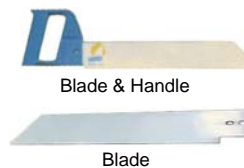

Part #	Mfg #	Description	Price
006260	20985-HSF12	12" Blade & Rubberized Handle	
006261	20980-HSF18	18" Blade & Rubberized Handle	
006258	20982-HSB12	12" Replacement Blade	
006259	20981-HSB18	18" Replacement Blade	

Tools

Saws & Blades

Bi-Metal Hacksaw Blades

- Bi-metal construction allows blades to bend and flex without breaking
- TUFF TOOTH™ design eliminates tooth strippage



Part #	Mfg #	TPI	Length x Width	Pkg Qty	Applications	Price
006302	20116-218HE	18	12" x 1/2"	100	Heavy Metal	
096100	20141-V024HE	24	10" x 1/2"	10	Medium Metal	
006282	20111-024HE	24	10" x 1/2"	100	Medium Metal	
006305	20117-224HE	24	12" x 1/2"	100	Medium Metal	
006283	20112-032HE	32	10" x 1/2"	100	Non-ferrous Metals	
006306	20118-232HE	32	12" x 1/2"	100	Non-ferrous Metals	

Reciprocating Saw Blades

Lenox® Gold™ Reciprocating Blade

- Longest lasting blade ever™
- Reinforced tooth design and precision applied titanium coating dissipate heat
- Titanium coating makes teeth more wear resistant so they stay sharp for quicker cuts
- Bi-metal design stands up to the most demanding applications

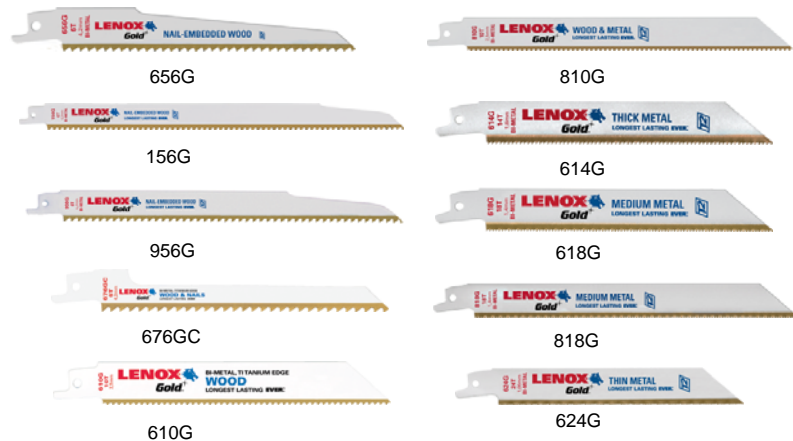

Part #	Mfg #	TPI	L x W x Thick	Pkg Qty	Applications	Price
089084	21060-656G	6	6" x 3/4" x .050"	5	Wood, Drywall & Plaster	
089095	21061-156G	6	12" x 3/4" x .050"	5	Wood, Drywall & Plaster	
089094	21062-956G	6	9" x 3/4" x .050"	5	Wood, Drywall & Plaster	
089085	21063-676GC	6	6" x 7/16" x .050"	5	Scroll Cutting, Wood	
089086	21064-610G	10	6" x 3/4" x .035"	5	Wood & Thick Metal (1/8" - 1/2")	
089090	21065-810G	10	8" x 3/4" x .050"	5	Wood & Thick Metal (1/8" - 1/2")	
089087	21067-614G	14	6" x 3/4" x .035"	5	Thick to Medium Metal (3/32" - 1/2")	
089088	21069-618G	18	6" x 3/4" x .035"	5	Medium Metal (3/32" - 5/16")	
089091	21070-818G	18	8" x 3/4" x .035"	5	Medium Metal (3/32" - 5/16")	
089089	21072-624G	24	6" x 3/4" x .035"	5	Thin Metal (1/8" & Less)	

Tools

Saws & Blades

Demolition Blade

- Engineered to rip through a wide array of materials with ease including structural steel, lumber, pipe and nail embedded wood
- Wider and thicker to stand up to the brutal conditions in demolition applications
- Shatter-resistant, bi-metal design provides the flexibility and durability single-metal blades can't



Part #	Mfg #	TPI	L x W x Thick	Pkg Qty	Applications	Price
020402	20598-966R	6	9" x 7/8" x .062"	2	Demolition, Drywall & Plaster	
089079	20500-106R	6	12" x 7/8" x .062"	2	Demolition, Drywall & Plaster	
020401	20597-960R	10	9" x 7/8" x .062"	2	Demolition	

Lazer™ Reciprocating Saw Blade

- Best for extreme metal cutting
- Reinforced tooth design ensures higher performance in the most demanding jobs
- A wider, thicker body than conventional blades delivers whip-free cuts that stay straight and smooth
- Lasts up to 45% longer than competitors blades
- Shatter-resistant, bi-metal design provides the flexibility and durability single-metal blades can't

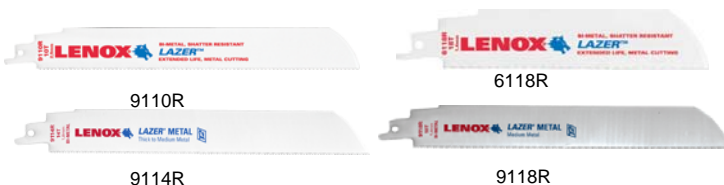

Part #	Mfg #	TPI	L x W x Thick	Pkg Qty	Applications	Price
102718	20176-9110R	10	9" x 1" x .042"	5	Structural Steels & All Metals	
089080	20178-9114R	14	9" x 1" x .042"	5	Structural Steels & All Metals	
077700	20174-6118R	18	6" x 1" x .042"	5	Structural Steels & All Metals	
110795	20180-9118R	18	9" x 1" x .042"	5	Structural Steels & All Metals	

Lenox Lazer Gold™ Reciprocating Saw Blade

- Titanium edge
- Bi-metal technology
- Designed for heavy metal cutting
- Shatter-resistant

Part #	Mfg #	TPI	L x W x Thick	Pkg Qty	Applications	Price
089101	21090-966GR	6	9" x 7/8" x .062"	5	Demolition & Wood	
089106	91091-106GR	6	12" x 7/8" x .062"	5	Demolition, Cast Iron, Wood	
089102	21089-960GR	10	9" x 7/8" x .062"	5	Demolition, Cast Iron, Wood	
089103	21097-9110GR	10	9" x 1" x .042"	5	Heavy Metals	
089107	21100-12110GR	10	12" x 1" x .042"	5	Heavy Metals	
089099	21094-6114G	14	6" x 1" x .042"	5	Medium Metals & Heavy Metals	
089104	21098-9114G	14	9" x 1" x .042"	5	Medium Metals & Heavy Metals	
089100	21095-6118GR	18	6" x 1" x .042"	5	Medium Metals	
089105	21099-9118GR	18	9" x 1" x .042"	5	Medium Metals	

Tools

Saws & Blades

Diamond™ Reciprocating Saw Blade

- Lasts three times longer than convention carbide grit
- Narrow kerf design enables thinner, faster cuts



Part #	Mfg #	Grit	L x W x Thick	Pkg Qty	Applications	Price
102459	10833	Diamond	8" x 3/4" x .040	1	Cast Iron, Tile, Brick & Stone	

Master-Grit® Reciprocating Saw Blade

- Cuts through materials that resist chip-forming
- Uniformly applied, durable carbide grit particles on a flexible blade provide fast cuts without snagging or binding

















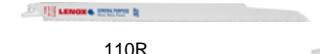



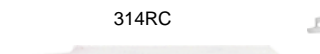

800RG

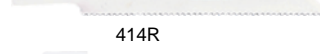
Part #	Mfg #	Grit	L x W x Thick	Pkg Qty	Applications	Price
006363	20576-800RG	Medium	8" x 3/4" x .040"	2	Fiberglass, Ceramic Tile, Clays, Brick	

Bi-Metal™ Reciprocating Saw Blade

- Patented TUFF TOOTH™ design provides long blade life
- Optimized for specific applications
- Shatter-resistant, bi-metal design provides the flexibility and durability single-metal blades can't

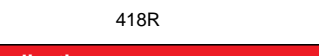
 634R	 810R	 650R	 618R
 456R	 956R	 110R	 818R
 636RP	 156R	 314RC	 118R
 656R	 610R	 414R	 424R
 676RC	 614R	 318RC	 624R
		 418R	

Part #	Mfg #	TPI	L x W x Thick	Pkg Qty	Applications	Price
006353	20575-634R	4	6" x 3/4" x .050"	5	Wood	
089082	20449-456RP	6	4" x 3/4" x .050"	5	Drywall & Plaster	
044001	20497-B636RP	6	6" x 3/4" x .050"	25	Drywall & Plaster	
006356	20572-656R	6	6" x 3/4" x .050"	5	Wood & Nail-Embedded Wood	
025881	20530-B656R	6	6" x 3/4" x .050"	25	Wood & Nail-Embedded Wood	
006358	20556-676RC	6	6" x 7/16" x .050"	25	Wood, Metal, Plastics & Composites	
006364	20580-810R	10	8" x 3/4" x .050"	5	Wood, Metal, Plastics & Composites	
057892	20590-B810R	10	8" x 3/4" x .050"	25	Wood, Thick Metal, Plastics & Composites	
006367	20582-956R	6	9" x 3/4" x .050"	5	Wood & Nail-Embedded Wood	
006295	20585-156R	6	12" x 3/4" x .050"	5	Wood & Nail-Embedded Wood	
025882	20493-B610R	10	6" x 3/4" x .035"	25	Wood, Metal, Plastics & Composites	
006349	20562-610R	10	6" x 3/4" x .035"	5	Wood, Metal, Plastics & Composites	
006350	20564-614R	14	6"x3/4 x.035"	5	Non-ferrous & Medium Metal	
024968	20592-650R	10/14	6" x 3/4" x .050"	1	Demolition	
006286	20583-110R	10/14	12" x 3/4" x .050"	5	Wood & Medium Metal (3/32" - 5/16")	

Saws & Blades

Reciprocating Saw Blades (Continued)

Bi-Metal™ Reciprocating Saw Blade

Part #	Mfg #	TPI	L x W x Thick	Pkg Qty	Applications	Price
006316	20520-314RC	14	3-5/8" x 5/16" x .035"	5	Wood & Medium Metal	
006331	20550-414R	14	4"x3/4"x.035"	5	Non-ferrous & Medium Metal (3/32"-5/16")	
006317	20521-318RC	18	3"x1/4"x.032"	5	Pressure-Treated Wood & Medium Metal	
006332	20552-418R	18	4" x 3/4" x .035"	5	Non-ferrous & Thin Metal (1/8" & Less)	
006351	20566-618R	18	6" x 3/4" x .035"	5	Non-ferrous & Thin Metal (1/8" & Less)	
033466	20529-B618R	18	6" x 3/4" x .035"	25	Non-ferrous & Thin Metal (1/8" & Less)	
028034	20578-818R	18	8" x 3/4" x .035"	5	Non-ferrous & Thin Metal (1/8" & Less)	
089077	21510-118R	18	12" x 3/4" x .035"	5	Non-ferrous & Thin Metal (1/8" & Less)	
006334	20554-424R	24	4" x 3/4" x .035"	5	Thin Metal (1/8" & Less)	
006352	20568-624R	24	6" x 3/4" x .035"	5	Thin Metal (1/8" & Less)	

Band Saw Blades

Wolf-Band® Portable Band Saw Blade

- Long lasting high speed steel teeth
- Shatter-resistant



Part #	Mfg #	TPI	Pk Qty	Price
094920	38428	10/14	1	

Saws & Blades

Abrasive Saw

- Heavy-duty cast iron base with non-slip rubber feet
- D-Handle grip ergonomic handle
- Die cast aluminum motor housing with externally accessible brushes
- Tool-less fence adjustment
- Arbor lock and arbor wrench included
- Miter cut to 45°



Replacement Saw Blade

Part #	Mfg #	Description	Price
067703	46956	14" Abrasive Disks for Steel, 10/Pk	

Pipe Saws
PVC/ABS Pipe Saw



Part #	Mfg #	Model	Description	Price
108804	50532	1205-2	18" Replacement Blade	

Tools

Saws & Blades

Hand Saws

Compact Hack Saw

- Tool-free blade change
- Adjustable blade length
- Rubber over mold grip



Part #	Mfg #	Description	Price
137579	48-22-0012	Includes (1) 10" Blade	

Rasping Jab Saw

- Rasping holes along the side of the blade to rapidly expand holes or smooth rough edges of sheet rock
- Rubber over mold grip
- 6" Plaster/dry wall blade



Part #	Mfg #	Description	Price
137581	48-22-0304	6" Rasping Jab Saw	

Folding Jab Saw

- Folds for easy storage
- Uses standard Sawzall® blades
- Includes:
 - (1) Folding jab saw
 - (3) Reciprocating blades (metal, wood, multi-purpose)



Part #	Mfg #	Description	Price
137583	48-22-0305	6" Folding Jab Saw	

Sawzall® Blades

- Matrix II high speed steel teeth with 8% cobalt, tough bi-metal design; 1/2" universal tang

SAWZALL® Blades

- NAIL GUARD™ Ordinary teeth deliver either speed or durability. NAIL GUARD™ solves this trade-off with an aggressive 5 TPI pattern for faster cuts and a unique design that protects against tooth fracture
- FANG TIP™ Ordinary tips bounce or skate on the work piece. FANG TIP™ bites into the wood on first contact.
- Matrix II bi-metal teeth for greater durability



(5 Pk)

Part #	Mfg #	Description	Price
164267	48-00-5091	6" 8/12 TPI SAWZALL® Blades (5 Pk)	
164207	48-00-5092	6" 10 TPI SAWZALL® Blades (5 Pk)	

Sawzall® Blades (Continued)

SAWZALL® Blades

(5 Pk)

Part #	Mfg #	Description	Price
164210	48-00-5182	6" 14 TPI SAWZALL® Blades (5 Pk)	
164211	48-00-5184	6" 18 TPI SAWZALL® Blades (5 Pk)	
164212	48-00-5186	6" 24 TPI SAWZALL® Blades (5 Pk)	
164279	48-00-5093	8" 8/12 TPI SAWZALL® Blades (5 Pk)	
164202	48-00-5036	9" 5 TPI SAWZALL® Blades (5 Pk)	
164203	48-00-5016	9" 6 TPI SAWZALL® Blades (5 Pk)	
164273	48-00-5187	9" 14 TPI SAWZALL® Blades (5 Pk)	
164274	48-00-5188	9" 18 TPI SAWZALL® Blades (5 Pk)	
164200	48-00-5037	12" 5 TPI SAWZALL® Blades (5 Pk)	
169673	48-00-5094	12" 8/12 TPI SAWZALL® Blades (5 Pk)	
167949	48-00-5194	12" 10/14 TPI SAWZALL® Blades (5 Pk)	

(25 Pk)

Part #	Mfg #	Description	Price
168482	48-01-2035	6" 5 TPI Sawzall® Blade (25 Pk)	
168483	48-01-2036	9" 5 TPI Sawzall® Blade (25 Pk)	

(50 Pk)

Part #	Mfg #	Description	Price
152610	48-01-6035	6" 5 TPI Sawzall® Blades (50 Pk)	

Saws & Blades

Thin Kerf SAWZALL® Blades

- Optimized tooth design providing 2X more life than our previous generation SAWZALL® blades
- Tough Neck™ ribs strengthen the blade tang and minimize breakage
- Grid Iron™ honeycomb pattern increases blade rigidity to resist blade buckling



(5 Pk)

Part #	Mfg #	Description	Price
167946	48-00-5181	4" 14 TPI Thin Kerf SAWZALL® Blades	

(25 Pk)

Part #	Mfg #	Description	Price
168363	48-01-2184	6" 18 TPI Thin Kerf SAWZALL® Blades (25 Pk)	
168364	48-01-2188	9" 18 TPI Thin Kerf SAWZALL® Blades (25 Pk)	

(100 Pk)

Part #	Mfg #	Description	Price
167948	48-01-7184	6" 18 TPI Thin Kerf SAWZALL® Blades (Bulk 100 Pk)	

Thin Kerf Ice Hardened™ SAWZALL® Blades

- Optimized tooth design providing 2X more life than our previous generation SAWZALL® blades
- Tough Neck™ ribs strengthen the blade tang and minimize breakage
- Grid Iron™ honeycomb pattern increases blade rigidity to resist blade buckling



(5 Pk)

Part #	Mfg #	Description	Price
169667	48-00-4182	6" 14 TPI Thin Kerf Ice Hardened™ SAWZALL® Blades	
167951	48-00-4189	12" 18 TPI Thin Kerf Ice Hardened™ SAWZALL® Blades (5 Pk)	

(50 Pk)

Part #	Mfg #	Description	Price
152609	48-01-8184	6" 18TPI Thin Kerf Ice Hardened™ SAWZALL® Blades (50Pk)	

The Torch™ SAWZALL® Blades

- Optimized tooth design providing 2X more life than our previous generation
- SAWZALL® blades Tough Neck™ ribs strengthen the blade tang and minimize breakage
- Grid Iron™ honeycomb pattern increases blade rigidity to resist blade buckling



(5 Pk)

Part #	Mfg #	Description	Price
152136	48-00-5712	6" 10 TPI The Torch™ SAWZALL® Blades (5 Pk)	
152137	48-00-5782	6" 14 TPI The Torch™ SAWZALL® Blades (5 Pk)	
152139	48-00-5784	6" 18 TPI The Torch™ SAWZALL® Blades (5 Pk)	
164297	48-00-5786	6" 24 TPI The Torch™ SAWZALL® Blades (5 Pk)	
152129	48-00-5713	9" 10 TPI The Torch™ SAWZALL® Blades (5 Pk)	
152130	48-00-5787	9" 14 TPI The Torch™ SAWZALL® Blades (5 Pk)	
152131	48-00-5788	9" 18 TPI The Torch™ SAWZALL® Blades (5 Pk)	
164298	48-00-5790	9" 24 TPI The Torch™ SAWZALL® Blades (5 Pk)	
152132	48-00-5714	12" 10 TPI The Torch™ SAWZALL® Blades (5 Pk)	
152133	48-00-5794	12" 14 TPI The Torch™ SAWZALL® Blades (5 Pk)	
152134	48-00-5789	12" 18 TPI The Torch™ SAWZALL® Blades (5 Pk)	
169669	48-00-5791	12" 24 TPI The Torch™ SAWZALL® Blades (5 Pk)	

(25 Pk)

Part #	Mfg #	Description	Price
161705	48-01-2713	9" 10 TPI The Torch™ SAWZALL® Blades (25 Pk)	
168987	48-00-8787	9" 14 TPI The Torch™ SAWZALL® Blades (25 Pk)	

Saws & Blades

The Torch™ Ice Hardened™ SAWZALL® Blades

- Optimized tooth design providing 2X more life than our previous generation SAWZALL® blades
- Tough Neck™ ribs strengthen the blade tang and minimize breakage
- Grid Iron™ honeycomb pattern increases blade rigidity to resist blade buckling



(5 Pk)

Part #	Mfg #	Description	Price
169668	48-00-4784	6" 18 TPI The Torch™ Ice Hardened™ SAWZALL® Blades	
229537	48-00-4712	6" 10 TPI The Torch™ Ice	
229539	48-00-4713	9" 10 TPI The Torch™ Ice	
229538	48-00-4782	6" 14 TPI The Torch™ Ice	
229540	48-00-4788	9" 18 TPI The Torch™ Ice	

The Ax™ SAWZALL® Blades

- NAIL GUARD™ Ordinary teeth deliver either speed or durability. Nail Guard™ solves this trade-off with an aggressive 5 TPI pattern for faster cuts and a unique design that protects against tooth fracture
- FANG TIP™ Ordinary tips bounce or skate on the work piece. FANG TIP™ bites into the wood on first contact
- The 1" tall blade body reduces blade twisting for straighter, more accurate cuts
- Matrix II bi-metal teeth for greater durability



(5 Pk)

Part #	Mfg #	Description	Price
152529	48-00-5021	6" 5 TPI The Ax™ SAWZALL® Blades (5 Pk)	
152530	48-00-5026	9" 5 TPI The Ax™ SAWZALL® Blades (5 Pk)	
152531	48-00-5027	12" 5 TPI The Ax™ SAWZALL® Blades (5 Pk)	

(100 Pk)

Part #	Mfg #	Description	Price
167947	48-01-7021	6" 5 TPI The Ax™ SAWZALL® Blade (100 Pk)	

The Wrecker™ SAWZALL® Blades

- A precise manufacturing process creates a sharper cutting edge on each tooth for a faster cutting blade
- A complete, unset raker tooth on the blade tip allows for easier, faster plunging by minimizing walking and bouncing
- A thicker, more rigid blade body resists fracturing and bending for maximum durability
- The 1" tall blade body reduces blade twisting for straighter, more accurate cuts



(5 Pk)

Part #	Mfg #	Description	Price
152135	48-00-5701	6" 8 TPI The Wrecker™ SAWZALL® Blades (5 Pk)	
152128	48-00-5706	9" 8 TPI The Wrecker™ SAWZALL® Blades (5 Pk)	
152127	48-00-5711	12" 8 TPI The Wrecker™ SAWZALL® Blades (5 Pk)	

Fleam Ground SAWZALL® Blades

- Deep gullet design cuts up to 25% faster than standard wood blades
- Fleam ground process creates super sharp teeth for clean cuts
- Matrix II bi-metal teeth for greater durability



(5 Pk)

Part #	Mfg #	Description	Price
169671	48-00-5015	6" 6 TPI Fleam Ground SAWZALL® Blades (5 Pk)	

Carbide Grit SAWZALL® Blade

- Tungsten carbide for long life
- Coarse grit for fast cutting



Part #	Mfg #	Description	Price
169674	48-00-1420	6" Carbide Grit SAWZALL® Blade (3 Pk)	
159451	48-00-1430	9" Carbide Grit SAWZALL® Blade (3 Pk)	

Saws & Blades

Diamond Grit THE TORCH™ SAWZALL® Blade

- Diamond Grit delivers up to 30x longer life than standard carbide grit blades
- The precisely controlled size and placement of the diamond grit allow these blades to cut up to 2x faster than standard carbide grit blades
- The 1" tall blade body reduces blade twisting for straighter, more accurate cuts



Part #	Mfg #	Description	Price
152141	48-00-1440	6" Diamond Grit THE TORCH™ SAWZALL® Blade	
151654	48-00-1450	9" Diamond Grit The TORCH™ SAWZALL® Blade	

Wood Cutting Sawzall® Blade

- For cutting stock 3/8" and above
- Recommended for very fast cutting, nail-embedded wood, general roughing-in

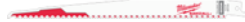

Part #	Mfg #	TPI	Blade Size	Pkg Qty	Price
141058	48-00-8036	6	9" x 3/4"	25/Pk	

Sawzall® Flush Cut Blade

- Floor guard shields teeth from floor contact during bottom plate cut-outs
- Double truss design guides blade for straight window cut-outs
- Nail Guard™ unique design protects against tooth fracture when cutting nails between studs and joists
- Fang Tip™ delivers fast plunge cutting for window cut-outs



Part #	Mfg #	TPI	Blade Size	Pkg Qty	Price
140976	48-00-1600	5	12" x 2-1/8"	1Pk	

Sawzall® Rough-In Blade

- Low blade profile cuts 2-1/8" diameter holes for 1-1/2" PVC pipe
- Can cut holes through double top plates
- NAIL GUARD™ Unique design protects against tooth fracture when cutting through holes in nail embedded wood
- FANG TIP™ fast plunge cutting through bottom plates and subfloors



Part #	Mfg #	TPI	Blade Size	Pkg Qty	Price
140978	48-00-1610	5	7-3/8" x 1/2"	5/Pk	

SUPER SAWZALL® Blade

- Double relief angle reduces tooth stress for long life
- Precision forming process creates sharper teeth for fast cutting
- Matrix II bi-metal teeth for greater durability



Part #	Mfg #	Description	Price
170458	48-00-5161	3-5/8" 10 TPI SUPER SAWZALL® Blade (5 Pk)	

Ductwork SAWZALL® Blade

- Pierce point tip geometry for quick plunging in ductwork with on tool
- Low blade profile for tight radius cuts
- Optimized tooth form designed specifically for cutting ductwork



Part #	Mfg #	Description	Price
169675	48-00-1630	Ductwork SAWZALL® Blade (5 Pk)	

Drywall Access SAWZALL® Blade

- Ideal for servicing plumbing and electrical
- Optimized length to minimize damage to pipe and wire
- Cut all directions
- Fast plunge



Part #	Mfg #	Description	Price
156089	48-00-1640	Drywall Access SAWZALL® Blade	

Pruning Sawzall® Blade



Part #	Mfg #	TPI	Blade Size	Pkg Qty	Price
142581	48-00-1303	5	12" x 3/4"	5/Pk	

High-Carbon Steel Jig Saw Blade

- Heavy duty: Advanced construction for long life in tough professional applications
- Fast cuts; Tooth shape and sharpness permit clean scroll cutting in wood
- Versatile: Fits any jig saw that accepts a T-shank blade

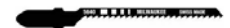

Part #	Mfg #	Description	Price
162387	48-42-5640	3" 12 TPI High-Carbon Steel Jig Saw Blade (5 Pk)	

Saws & Blades

Sawzall® Blade Sets

12-Piece Assortment General Purpose Sawzall® Blade Kit

• Includes:

- (4) 6" 18 TPI The Torch blades
- (2) 6" 8 TPI The Wrecker blades
- (2) 6" 5 TPI The Ax blades
- (2) 9" 5 TPI The Ax blades
- (2) 9" 14 TPI The Torch blades
- (1) Storage container



Part #	Mfg #	Description	Price
143952	49-22-1129	12-Pc General Purpose Blade Kit	

Hackzall™ Blades

M12 Hackzall™ Blade



Part #	Mfg #	TPI	Length	For	Pkg Qty	Price
144141	49-00-5310	10	3-1/2"	Wood	5/Pk	
144142	49-00-5324	24	3-1/2"	Metal	5/Pk	
144143	49-00-5461	6	4"	Plaster	5/Pk	

M12 Hackzall™ Blade 10-Pc Set

• Includes:

- (2) Wood blades
- (3) EMT Blades
- (2) Duct Blades
- (3) PVC Blades
- Storage pouch



Part #	Mfg #	Description	Price
143951	49-22-0220	M12™ Hackzall™ 10-Pc Set	

Sawzall® & Hackzall® Accessories

Scraper Blade

- Fits all Sawzall® and Hackzall® reciprocating saws
- Induction hardened blade edge
- Corrosion resistant coating
- Chambered corners prevent digging into work material
- Resharpenable blade



Part #	Mfg #	Description	Price
148390	49-00-5463	1-1/2" Scraper Blade	
148391	49-00-5456	3" Scraper Blade	
159007	49-00-5455	5" Scraper Blade	

Grout Removal Tool

- Fits all SAWZALL® and HACKZALL™ recip saws
- Curved cutting edge for maximum accuracy
- Coarse carbide grit for fast grout removal
- Corrosion resistant coating for longer life



Part #	Mfg #	Description	Price
159006	49-00-5450	Grout Removal Tool	

Shear & Nibbler Accessories

PVC Shear Blade

- Compatible only with the M12™ PVC Shear Tool
- Reinforced cutting edge
- Pierce point design
- Designed to cut PVC, CPVC, PEX, non-metallic conduit and rubber hose
- Blade dimensions: 4" x 2.5" x 0.149"
- High strength stainless steel
- Bowtie connection



Part #	Mfg #	Description	Price
140717	48-44-0400	(1) Shear Replacement Blade	

Saws & Blades

Band Saw Blades

Bi-Metal Band Saw Blade

- 44-7/8" x 1/2" x 0.020"
- Matrix II high speed steel teeth with 8% cobalt
- For the fastest cutting, longest life blade life available

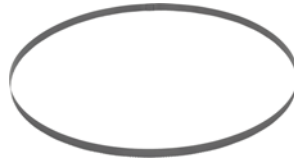

Part #	Mfg #	TPI	Dia or Wall Thickness	Pkg Qty	Price
169677	48-39-0500	10 TPI	Standard Deep Cut	Portable Band Saw Blade	
138593	48-39-0511	14 TPI	Standard Deep Cut	Portable Saw Blade	
169676	48-39-0520	18 TPI	Standard Deep Cut	Portable Band Saw Blade	
160569	48-39-0531	24 TPI	Standard Deep Cut	Portable Band Saw Blade	

Compact Portable Band Saw Blade

- Matrix II high speed steel teeth
- Alloy backing steel
- Precision formed teeth
- For cutting common materials 3/16" - 5/16" thick and very hard materials 5/16" to 1/2" thick



Part #	Mfg #	TPI	Blade Dimensions	Pkg Qty	Price
163508	48-39-0518	14 TPI	Compact Portable	Band Saw Blade	
149985	48-39-0519	14	35-3/8" x 1/2"	3	
152649	48-39-0529	18 TPI	Compact Portable	Band Saw Blade	
163509	48-39-0538	24 TPI	Compact Portable	Band Saw Blade	
160570	48-39-0539	24 TPI	Compact Portable	Band Saw Blade	

Circular Saw Blade

Circular Saw Blade 6-1/2" 24 Carbide Teeth (1 per pack)

- 6-1/2 in. diameter, 24 carbide teeth
- 5/8 in. arbor
- Thin kerf for faster cutting
- Framing and ripping blade
- Anti-kickback shoulder
- Precision ground carbide
- Expansion slots for truer cuts under heavy use



Part #	Mfg #	Description	Price
151837	48-40-4108	Circular Saw Blade 6-1/2" 24 Carbide Teeth (1 per pack)	

Circular Saw Blade 6-1/2" 48 Carbide Teeth (1 per pack)

- 6-1/2 in. diameter, 48 carbide teeth
- 5/8 in. arbor
- Anti-kickback design
- Cuts ferrous metals



Part #	Mfg #	Description	Price
151836	48-40-4015	Circular Saw Blade 6-1/2" 48 Carbide Teeth (1 per pack)	

7-1/4" 16 Carbide Teeth Circular Saw Blade

- 7-1/4 in. diameter, 16 carbide teeth
- 5/8 in. arbor with diamond knockout
- Thin kerf for faster cutting
- Framing and ripping blade
- Anti-kickback shoulder
- Precision ground carbide
- Expansion slots for truer cuts under heavy use



Part #	Mfg #	Description	Price
155049	48-40-4116	7-1/4" 16 Carbide Teeth Circular Saw Blade	



Saws & Blades

7-1/4" 40 Carbide Teeth Circular Saw Blade

- 7-1/4 in diameter, 40 carbide teeth
- 5/8 in arbor with diamond knockout
- Thin kerf for faster cutting
- Trim and finish blade
- Anti-Kickback shoulder
- Precision ground carbide
- Expansion slots for truer cuts under heavy use



Part #	Mfg #	Description	Price
154493	48-40-4126	7-1/4" 40 Carbide Teeth Circular Saw Blade	

Saws & Blades

Hand Saws

Mini Hacksaw—Pistol Grip & Standard

- Separate screw sets the 6" blade tension
- Good for fine work in small areas.
- Six inch steel blade cuts copper and brass tube, bolts, steel, wood and plaster
- Pistol Grip is easier to hold and grasp



301-062

Part #	Mfg #	Type	Blade	Price
031884	301-062	Deluxe Pistol Grip	6"	
183402	301-065	Standard D-Type	6"	

SawHorse™ Multi-Purpose Saw

- High-quality, hardened-steel blade remains sharp through thousands of cuts
- Teeth are on the nose for notching in tight areas and starting cuts in the middle of floor or wall
- Perfect for plastic pipe, wood and many other materials
- 20" model has 10 teeth/inch for faster cutting
- 12" model has 13 teeth/inch for fine cutting.
- Both include plastic teeth protector



300-20

Part #	Mfg #	Blade Size	Price
049442	300-12	20"	
183400	300-20	12"	

Replacement Blades

For: SawHorse™ Multi-Purpose Saws

Part #	Mfg #	For Model:	Price
051535	300-12B	300-12	

For: Mini Hacksaw—Pistol Grip & Standard

- 32 Teeth/Inch
- Pin ends

Part #	Mfg #	Material	Blade	Price
031885	301-061	Carbon Steel	6"	

Tools

Saws & Blades

Saws

PlumBest Plastic Pipe Saw

- Die cast aluminum handle
- Large comfortable grip
- Flame hardened blade
- Quickly cuts PVC, ABS, wood, sheetrock, etc.
- 18" Blade has 10 TPI



Part #	Mfg #	Description	Price
054589	S49-001	18" Blade & Handle	

E-Z Stroke Pipe Saw

- Tri-edge teeth are borazon wheel ground
- For smooth, fast, accurate cutting
- Pull-stroke cutting action
- Cuts plastic pipe and wood
- Replaceable blade



S49-005



S49-006

Part #	Mfg #	Description	Price
044951	S49-005	8" E-Z Stroke Pipe Saw	
045193	S49-006	8" Replacement Blade	
044963	S49-008	12" E-Z Stroke Pipe Saw	
045192	S49-007	12" Replacement Blade	

Drywall Saw

- High quality carbon steel blade
- Great for sheetrock, wallboard, gypsum, plywood, wood and plastic pipe
- 6" to 8 TPI Aggressive tooth design ensures super sharp, fast and easy cut
- Comfortable grip with thumb stop for greater leverage
- Handy wrist strap



Part #	Mfg #	Description	Price
055539	S49-012	Drywall Saw	

Close Quarters Hacksaw

- Nickel-plated steel frame
- Cuts wood, plastic, brass, aluminum and steel



S50-060



S50-062

Part #	Mfg #	Description	Price
005881	S50-060	6" Hacksaw	
111480	S50-062	6" Adjustable Hacksaw	
005882	S50-061	Blades 32 Per Inch	

Saws & Blades

Jab Saw

- Cuts drywall, wallboard, plywood, and plastic
- Triple ground teeth for a fast cut
- Blade cuts in both directions (push and pull)
- Hardened, carbon steel blade for durability
- Hardened, beveled blade point for scoring and plunge cuts
- Comfort cushion grip with thumb groove
- Handle structure designed for strength and durability
- Flat end grip for palming or punching through drywall



Part #	Mfg #	Blade Length	Overall Length	Price
106821	725	6"	12"	



Saws & Blades

Hole Saws Replacement Blade

Part #	Mfg #	Diameter	Price
072037	RBW68	4-1/4"	

Saws & Blades

Saws

PVC Cable Saw

- *Cuts plumbing or electrical PVC faster than hacksaw*
- *Ideal for tight spots and in-ground repairs*

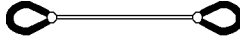

Part #	Mfg #	Description	Price
002737	70390	26" Cable Saw - Std	

Screwdrivers & Bits

All-In-One Screwdrivers

Part #	Mfg #	Description	Price
096916	23931	6-In-1	
094730	23932	9-In-1	

Screwdrivers & Bits

Screwdrivers

Regular Grip Screwdriver - Electrical Style



Part #	Mfg #	Blade Dia	Blade Length	Price
006380	C22M	1/8"	2"	

Nut Drivers

CONNEXT™ Pre-Assembled Magnetic Hex Driver - Long Lengths



- CONNEXT™ Quick change handles
- Magnetic hex chuck driver shaft components
- Use with Zip-In® and "A" hex head screws

Part #	Mfg #	Hex Dia	Shaft Length	Grips	Price
006416	HHD1	1/4"	6-7/8"	Red	
006417	HHD2	5/16"	6-7/8"	Yellow	

CONNEXT™ Pre-Assembled Magnetic Hex Driver - Standard Lengths



- CONNEXT™ Quick change handles
- Magnetic hex chuck driver shaft components
- Use with Zip-In® and "A" hex head screws

Part #	Mfg #	Hex Dia	Shaft Length	Grips	Price
132792	HHD1S	1/4"	3"	Red	

CONNEXT™ Pre-Assembled Magnetic Hex Driver - Stubby



- CONNEXT™ Quick change handle
- Magnetic hex chuck driver shaft components
- Use with Zip-In® and "A" hex head screws

Part #	Mfg #	Hex Dia	Shaft Length	Grips	Price
132795	HHD2T	5/16"	2-1/4"	Yellow	

Power Bits

Phillips Power Bit



- 1/4" Shank diameter

Part #	Mfg #	Point Size	O/A Length	Price
006444	MBLP3	2	1-15/16"	

Magnetic Hex Driver Bit



- 1/4" Shank diameter

Part #	Mfg #	Hex Opening	Nose Diameter	Price
006447	MSH1/4	1/4"	7/16"	
006449	MSH5/16	5/16"	1/2"	
006448	MSH3/8	3/8"	9/16"	

Long Style Hex Driver Bit



- 1/4" Shank diameter

Part #	Mfg #	Hex Opening	Nose Dia	Qty	Price
006446	MSHL1/4	1/4"	7/16"	1	
025655	MSHL5/16	5/16"	1/2"	1	

Extra Long Style Hex Driver Bit



- 1/4" Shank diameter

Part #	Mfg #	Hex Opening	O/A Length	Price
025042	MSHML1/4	1/4"	4"	
023240	MSHXL1/4	1/4"	6"	
096867	MSHXL5/16	5/16"	6"	

Power Bit Extension



- Ball bearing on holder provides a positive lock on 1/4" hex
- Tempered steel
- Black finish
- 9/16" Nose diameter

Part #	Mfg #	Hex Opening	O/A Length	Price
006378	BHE6	1/4"	6"	
006377	BHE10	1/4"	10"	

Power Driver Hex Adapters

Quick Change Hex Adapter



Part #	Mfg #	Hex Dia	Shank Dia	O/A Length	Price
006407	HAD1	1/4"	3/4"	1-3/4"	

Screwdrivers & Bits

Screwdrivers

#1 Philips - 3" Screwdriver

- Wrench ready HEX shanks deliver additional leverage 
- Forged tool shanks deliver more durability and longer life
- Wire bending hole- bend up to 12 gauge wire
- Wire stripper (Patent Pending)- strip up to 12 gauge wire
- Visible ID markings allows for quick tool identification on job site

Part #	Mfg #	Description	Price
169658	48-22-2011	#1 Philips - 3" Screwdriver	

#2 Philips - 4" Screwdriver

- Wrench ready HEX shanks deliver additional leverage 
- Forged tool shanks deliver more durability and longer life
- Wire bending hole - bend up to 12 gauge wire
- Wire stripper (Patent Pending) - strip up to 12 gauge wire
- Visible ID markings allow for quick tool identification on job site

Part #	Mfg #	Description	Price
169659	48-22-2012	#2 Philips - 4" Screwdriver	

#3 Philips - 6" Screwdriver

- Wrench ready HEX shanks deliver additional leverage 
- Forged tool shanks deliver more durability and longer life
- Wire bending hole - bend up to 12 gauge wire
- Wire stripper (Patent Pending) - strip up to 12 gauge wire
- Visible ID markings allows for quick tool identification on job site

Part #	Mfg #	Description	Price
169660	48-22-2013	#3 Philips - 6" Screwdriver	

5/16" Slotted- 6" Demolition Screwdriver

- Wrench ready HEX shanks deliver additional leverage 
- High impact steel cap
- Forged tool shanks deliver more durability and longer life
- Visible ID markings allows for quick tool identification on jobsite

Part #	Mfg #	Description	Price
162649	48-22-2022	5/16" Slotted- 6" Demolition Screwdriver	

3/8" Slotted - 8" Demolition Screwdriver

- Wrench ready HEX shanks deliver additional leverage 
- High impact steel cap
- Forged tool shanks deliver more durability and longer life
- Visible ID markings allows for quick tool identification on jobsite

Part #	Mfg #	Description	Price
162625	48-22-2023	3/8" Slotted- 8" Demolition Screwdriver	

Multi-Tip 11-in-1 Screwdriver

- Features ECX™ bits and hardened tips 
- Includes:
 - (9) Bits and nut drivers
 - Integrated gut hook
 - Integrated wire stripper
 - Wire bending hole - bends up to 12 gauge wire

Part #	Mfg #	Description	Price
137586	48-22-2113	Screwdriver/Nut Driver	

11 IN 1 Screwdriver w/Square Drive

- Wire stripper (patent pending) strip up to 12ga wire 
- Wire bending hole- bend up to 12ga wire
- 7 bit types

Part #	Mfg #	Description	Price
162648	48-22-2114	11 IN 1 Screwdriver w/ Square Drive	

Screwdrivers & Bits

10IN1 SAE HEX Key Driver

- Milwaukee® SAE Hex key driver offers improved functionality vs. traditional folding keys 
- 3-1/2" Power groove bits for power tool compatibility
- Revolver style bit storage and selection
- Up to 10ga wire stripper and loop maker for additional job site functionality
- Chrome plated bits
- Magnetic bit retention delivers consistent driving performance
- Wrench ready HEX shanks deliver additional leverage
- Includes:
 - (1) 10IN1 Handle
 - (1) 3 1/2" HEX x 1/4"
 - (1) 3 1/2" HEX x 1/8"
 - (1) 3 1/2" HEX x 3/16"
 - (1) 3 1/2" HEX x 5/32"
 - (1) 3 1/2" HEX x 7/32"
 - (1) 3 1/2" HEX x 7/64"
 - (1) 3 1/2" HEX x 9/64"

Part #	Mfg #	Description	Price
163154	48-22-2104	10IN1 SAE HEX Key Driver	

10IN1 TORX® Key Driver

- Milwaukee® TORX® Key Driver offers improved functionality vs. traditional folding keys 
- 3-1/2" Power groove bits for power tool compatibility
- Revolver style bit storage and selection
- Up to 10ga wire stripper and loop maker for additional job site functionality
- Chrome plated bits
- Magnetic bit retention delivers consistent driving performance
- Wrench ready HEX shanks deliver additional leverage
- Includes:
 - (1) 10IN1 Handle
 - (1) 3 1/2" TORX® T8
 - (1) 3 1/2" TORX® T10
 - (1) 3 1/2" TORX® T15
 - (1) 3 1/2" TORX® T20
 - (1) 3 1/2" TORX® T25
 - (1) 3 1/2" TORX® T27
 - (1) 3 1/2" TORX® T30

Part #	Mfg #	Description	Price
162804	48-22-2103	10IN1 TORX® Key Driver	

10IN1 Metric HEX Key Driver

- Milwaukee® Metric HEX key driver offers improved functionality vs. traditional folding keys 
- 3-1/2" Power groove bits for power tool compatibility
- Revolver style bit storage and selection
- Up to 10ga wire stripper and loop maker for additional job site functionality
- Chrome plated bits
- Magnetic bit retention delivers consistent driving performance
- Wrench ready HEX shanks deliver additional leverage
- Includes:
 - (1) 10IN1 Handle
 - (1) 3 1/2" HEX x 1.5mm
 - (1) 3 1/2" HEX x 2mm
 - (1) 3 1/2" HEX x 2.5mm
 - (1) 3 1/2" HEX x 3mm
 - (1) 3 1/2" HEX x 4mm
 - (1) 3 1/2" HEX x 5mm
 - (1) 3 1/2" HEX x 6mm

Part #	Mfg #	Description	Price
163155	48-22-2106	10IN1 Metric HEX Key Driver	

10IN1 Square Drive Multi Bit Driver

- 3-1/2" Power groove bits for power tool compatibility 
- Revolver style bit storage and selection
- Up to 10ga wire stripper and loop maker for additional job site functionality
- Chrome plated bits
- Magnetic bit retention delivers consistent driving performance
- Wrench ready™ HEX shanks deliver additional leverage
- Includes:
 - (1) 10IN1 Handle
 - (1) 3-1/2" Phillips #1
 - (1) 3-1/2" Phillips #2
 - (1) 3-1/2" Slotted 1/4"
 - (1) 3-1/2" Slotted 3/16"
 - (1) 3-1/2" Square drive #1
 - (1) 3-1/2" Square drive #2
 - (1) 3-1/2" Square drive #3

Part #	Mfg #	Description	Price
170691	48-22-2102	10IN1 Square Drive Multi Bit Driver	

Tools

Screwdrivers & Bits

10IN1 ECX™ Multi Bit Driver

- 3-1/2" Power groove bits for power tool compatibility
- Revolver style bit storage and selection
- Up to 10ga wire stripper and loop maker for additional jobsite functionality
- Chrome plated bits
- Magnetic bit retention delivers consistent driving performance
- Wrench ready™ HEX shanks deliver additional leverage
- Includes:
 - (1) 10IN1 Handle
 - (1) 3-1/2" ECX™ #1
 - (1) 3-1/2" ECX™ #2
 - (1) 3-1/2" Phillips #1
 - (1) 3-1/2" Phillips #2
 - (1) 3-1/2" Slotted 1/4"
 - (1) 3-1/2" Slotted 3/16"
 - (1) 3-1/2" Square Drive #2



Part #	Mfg #	Description	Price
161629	48-22-2101	10IN1 ECX Multi Bit Driver	

Compact 8IN1 Ratchet Multi Bit Driver

- All metal ratchet: durable high torque ratchet for 2x driving speed and maximum control
- Power groove bits for power tool compatibility and job site versatility
- Precision machined bit tips: durable driving tips for sector figment
- Wrench ready: hex shanks for additional leverage
- Chrome plated bits
- Includes:
 - (1) Compact 8IN1 Ratchet handle
 - (1) 1-1/2" Phillips #1 power groove bit
 - (1) 1-1/2" Phillips #2 power groove bit
 - (1) 1-1/2" Slotted 1/16" power groove bit
 - (1) 1-1/2" Slotted 3/32" power groove bit
 - (1) 1-1/2" Square recess #1 power groove bit
 - (1) 1-1/2" Square recess #2 power groove bit
 - (1) 1-1/2" TORX® 15 power groove bit



Part #	Mfg #	Description	Price
171804	48-22-2320	Compact 8IN1 Ratchet Multi Bit Driver	

10 IN 1 Square Drive Ratcheting Multi Bit Driver

- All metal high torque ratchet delivers more durability and 2X driving speed
- 3 1/2" Power groove bits for power tool compatibility
- Revolver style bit storage and selection
- Up to 10ga wire stripper and loop maker
- Chrome plated bits
- Magnetic bit retention delivers consistent driving performance
- Includes:
 - (1) 10in1 Ratchet handle
 - (1) 3 1/2" Phillips #1
 - (1) 3 1/2" Phillips #2
 - (1) 3 1/2" Slotted 1/4"
 - (1) 3 1/2" Slotted 3/16"
 - (1) 3 1/2" Square drive #1
 - (1) 3 1/2" Square drive #2
 - (1) 3 1/2" Square drive #3



Part #	Mfg #	Description	Price
169218	48-22-2302	10 IN 1 Square Drive Ratcheting Multi Bit Driver	

10IN1 ECX™ Ratcheting Multi Bit Driver

- All metal high torque ratchet delivers more durability and 2X driving speed
- 3 1/2" Power groove bits for power tool compatibility
- Revolver style bit storage and selection
- Up to 10ga wire stripper and loop maker
- Chrome plated bits
- Magnetic bit retention delivers consistent driving performance
- Includes:
 - (1) 10IN1 Ratchet handle
 - (1) 3 1/2" ECX™ #1
 - (1) 3 1/2" ECX™ #2
 - (1) 3 1/2" Phillips #1
 - (1) 3 1/2" Phillips #2
 - (1) 3 1/2" Slotted 1/4"
 - (1) 3 1/2" Slotted 3/16"
 - (1) 3 1/2" Square Drive #2



Part #	Mfg #	Description	Price
162815	48-22-2301	10IN1 ECX™ Ratcheting Multi Bit Driver	

Screwdrivers & Bits

8-Piece Screwdriver Set

- Includes:
 - 4" #1 & #2 ECX™
 - 3" & 4" #1 & #2 Phillips
 - 4" & 6" 1/4" & 5/16" Slotted
 - 3" & 6" 3/16" Cabinet



Part #	Mfg #	Description	Price
137587	48-22-2008	Steel Cap	

4 PC Precision Screwdriver Set

- All metal cores: up to 4x stronger
- Precision machined driving tips
- Longer shanks for improved visibility and extended reach
- 360-degree rotating back caps
- Color coded markings for easy identification
- Chrome plated shanks increase tool life by reducing corrosion
- Includes:
 - (1) Phillip #1 -4" Precision screwdriver
 - (1) Slotted 1/16" - 2 1/2" Precision screwdriver
 - (1) Slotted 3/32" - 2 1/2" Precision screwdriver
 - (1) Slotted 1/8" 3 1/2" Slotted precision screwdriver



Part #	Mfg #	Description	Price
171805	48-22-2604	4 PC Precision Screwdriver Set	

Shockwave® Impact Duty™ Bits

- Steel heat treated to control hardness
- Forged tip for maximum grip
- Geometric design provides the shock absorption zone

Shockwave® Reduced Diameter Dry wall Phillips Insert Bit



Part #	Mfg #	Dia	Lgth	Pkg Qty	Phillips	Price
141257	48-32-4444	1/4"	1"	2	#2	

Shockwave® Impact Duty™ Phillips Insert Bit



48-32-4411

Part #	Mfg #	Dia	Lgth	Pkg Qty	Phillips	Price
141251	48-32-4411	1/4"	1"	2	#1	
141255	48-32-4601	1/4"	1"	5	#2	
141256	48-32-4413	1/4"	1"	2	#3	

Shockwave® Impact Duty™ Phillips Power Bit



Part #	Mfg #	Dia	Lgth	Pkg Qty	Phillips	Price
141259	48-32-4602	1/4"	2"	5	#2	

SHOCKWAVE™ 2" Impact Phillips #1 Power Bit

- OPTIMIZED SHOCKZONE™ absorbs peak torque and prevents breaking
- PRECISE FIT CUSTOM MACHINED TIP™ prevents stripping and reduces wobble
- CUSTOM ALLOY76™ STEEL maximizes resistance to wear and shock



Part #	Mfg #	Description	Price
164161	48-32-4461	SHOCKWAVE™ 2" Impact Phillips #1 Power Bit	

SHOCKWAVE™ 3-1/2" Impact Phillips Power Bit

- OPTIMIZED SHOCKZONE™ Absorbs peak torque and prevents breaking
- PRECISE FIT CUSTOM MACHINED TIP™ prevents stripping and reduces wobble
- CUSTOM ALLOY76™ STEEL maximizes resistance to wear and shock



Part #	Mfg #	Description	Price
164164	48-32-4563	SHOCKWAVE™ 3-1/2" Impact Phillips #3 Power bit	

SHOCKWAVE™ 3-1/2" Impact Phillips #2 Power Bits (5PK)

- OPTIMIZED SHOCKZONE™ absorbs peak torque and prevents breaking
- PRECISE FIT CUSTOM MACHINED TIP™ prevents stripping and reduces wobble
- CUSTOM ALLOY76™ STEEL maximizes resistance to wear and shock



Part #	Mfg #	Description	Price
164174	48-32-4564	SHOCKWAVE™ 3-1/2" Impact Phillips #2 Power Bits (5PK)	

Screwdrivers & Bits

SHOCKWAVE™ Impact Phillips #2 Insert Bits (Contractor Pack)



Part #	Mfg #	Description	Price
164171	48-32-4604	Impact Phillips #2 Insert Bits - Contractor Pack (25QTY)	

Shockwave® Impact Duty™ Square Recess Insert Bit



48-32-4421



48-32-4471

Part #	Mfg #	Dia	Lgth	Pkg Qty	Phillips	Price
141262	48-32-4421	1/4"	1"	2	#1	
141266	48-32-4471	1/4"	2"	1	#1	
141263	48-32-4422	1/4"	1"	2	#2	
141265	48-32-4605	1/4"	1"	5	#2	
141268	48-32-4606	1/4"	2"	5	#2	
141264	48-32-4423	1/4"	1"	2	#3	
141269	48-32-4473	1/4"	2"	1	#3	
141270	48-32-4572	1/4"	3-1/2"	1	#2	

SHOCKWAVE™ 3-1/2" Impact Square Recss Power Bit

- OPTIMIZED SHOCKZONE™ absorbs peak torque and prevents breaking
- PRECISE FIT CUSTOM MACHINED TIP™ prevents stripping and reduces wobble
- CUSTOM ALLOY76™ STEEL maximizes resistance to wear and shock



Part #	Mfg #	Description	Price
164165	48-32-4573	SHOCKWAVE™ 3-1/2" Impact Square Recss #3 Power Bit	

Shockwave® Torx® Power Bit



Part #	Mfg #	Dia	Lgth	Pkg Qty	Torx	Price
164162	48-32-4482	1/4"	2"	T10		

Shockwave® Impact Duty™ Bits (Continued)

Shockwave® Torx® Power Bit

Part #	Mfg #	Dia	Lgth	Pkg Qty	Torx	Price
141271	48-32-4483	1/4"	2"	1	T15	
164163	48-32-4486	1/4"	2"	T27		
141274	48-32-4487	1/4"	2"	1	T30	

Shockwave® Bit Sets

22-Piece Shockwave® Puck Bit Dispenser

- Includes:
 - Magnetic bit holder
 - Phillips: (1) #1, (3) #2, (2) #
 - Square recess: (1) #1, (3) #2, (1) #3
 - Torx: (1) T10, (1) T15, (1) T20, (1) T25, (1) T27, (1) T30
 - Slotted: (1) 1/8", (1) 3/16", (1) 1/4", (1) 9/32"



Part #	Mfg #	Description	Price
143668	48-32-4011	22-Piece Shockwave® Puck Bit Dispenser	

Right Angle Drive Unit

- For use with Milwaukee 1/2" d-handle drills
- Provides 2 additional drilling speeds
- Includes coupling No. 42-90-0175 for 0234-6 and 0244-1
- For 50% more torque or 50% more speed



Part #	Mfg #	Description	Price
162598	48-06-2871	Right Angle Drive Unit	

11-Piece Shockwave® Impact Duty™ 30° Knuckle™ Pivoting Bit Holder Bit Set

- Locks at 0° or 30° angle
- Designed for use with Shockwave® Impact Duty™ 1/4" hex accessories
- Maximum torque: 2,000 in-lbs
- Includes:
 - Phillips bits: 1" P
 - Shockwave® 30° Knuckle™ pivoting bit holder 1, P2 & P3
 - Square bits: 1" SQ1 & SQ2
 - Slotted bits: 1" SL1/8", SL 3/16", SL1/4", SL9/32"
 - Torx® bits: 1" T25



Part #	Mfg #	Description	Price
146101	48-32-2301	11-Pc Shockwave Bit Set & Knuckle Bit Holder	

Screwdrivers & Bits

Shockwave® Impact Duty™ Nut Driver

Shockwave® Impact Duty™ Magnetic Nut Driver

- Steel heat treated to control hardness
- Color-coded rings for size identification
- Chamfered edge



Part #	Mfg #	Size	Pkg Qty	Price
141231	49-66-4502	1/4" x 1-7/8"	1	
140360	49-66-4503	5/16" x 1-7/8"	1	
164177	49-66-4537	1/2" x 2-9/16"	1	
141245	49-66-4525	3/8" x 1-7/8"	3	
141246	49-66-4526	7/16" x 1-7/8"	3	

SHOCKWAVE™ 1/4" Hex Adapter SQ 3/8"

- Proprietary steel and heat treat process for maximum strength and durability
- Heavy duty construction for fastening capabilities in all impacts



Part #	Mfg #	Description	Price
153737	48-03-4405	SHOCKWAVE™ 1/4" Hex Adapter SQ 3/8"	

SHOCKWAVE™ Square Socket Adapter

- Proprietary steel and heat treat process for maximum strength and durability
- Heavy duty construction for fastening capabilities in all impacts



Part #	Mfg #	Description	Price
164155	48-32-5030	SHOCKWAVE™ 1/4" Hex to 1/4" Square Socket Adapter	
154029	48-32-5031	SHOCKWAVE™ 1/4" Hex to 3/8" Square Socket	
164157	48-32-5032	SHOCKWAVE™ 1/4" Hex to 1/2" Square Socket Adapter	

SHOCKWAVE™ 1/2" Square to 1/4" Hex Adapter

- Proprietary steel and heat treat process for maximum strength and durability
- Heavy duty construction for fastening capabilities in all impacts



Part #	Mfg #	Description	Price
164154	48-03-4410	SHOCKWAVE™ 1/2" Square to 1/4" Hex Adapter	

Bit Sets

38-Piece Universal Quik-Lok™ Drill & Drive Set

- Universal Quik-Lok™ locks-in double ended, insert, and power groove drill bits
- Made of premium grade S2 tool steel
- Titanium hex shank bits
- Magnetic nut drivers



Part #	Mfg #	Description	Price
138409	48-32-1500	38-Pc Quick-Lok™ Drill & Drive Set	

4-Piece Replacement Bit Set

- Universal fit
- Includes:
 - ECX Bit #1 & #2
 - Phillips #1 & #2
 - Slotted 3/16" & 1/4"
 - Square #1 & #2



Part #	Mfg #	Description	Price
142609	48-22-2110	4-Pc Replacement Bit Set	

Screwdrivers & Bits

Nut Drivers

Hollow Shaft Nut Driver

- Universal driver head fits 4X more fasteners
- Removes rusted and stripped bolts
- 3" Hollow shaft depth
- Wrench ready HEX shanks deliver additional leverage
- Chrome plated - marine grade rust protection
- Forged steel shanks provide longer life and more durability
- Deep well sockets
- Multiple ID markings allow for quick tool identification on job site



Part #	Mfg #	Description	Price
163305	48-22-2421	1/4" HollowCore Driver	
163306	48-22-2422	5/16" HollowCore Driver	

HollowCore™ Magnetic Nut Driver

- HollowCore™ unlimited depth
- Magnetic drivers
- Universal driver head fits 4X more fasteners
- Removes rusted and stripped bolts
- Color coded ID markings allow for quick tool identification on job site
- Wrench ready HEX shanks deliver additional leverage
- Chrome plated- marine grade rust protection
- Forged steel shanks provide longer life and more durability
- Deep well sockets



Part #	Mfg #	Description	Price
162644	48-22-2521	1/4" HollowCore™ Magnetic Nut Driver	
162645	48-22-2522	5/16" HollowCore™ Magnetic Nut Driver	
162646	48-22-2524	3/8" HollowCore™ Magnetic Nut Driver	
162817	48-22-2525	7/16" HollowCore™ Magnetic Driver	
162818	48-22-2526	1/2" HollowCore™ Magnetic Driver	
162819	48-22-2527	9/16" HollowCore™ Magnetic Driver	
162816	48-22-2523	11/32" HollowCore™ Magnetic Driver	

2PC SAE Hollow Shaft Nut Driver Set

- Universal driver head fits 4X more fasteners
- Removes rusted and stripped bolts
- 3" Hollow shaft depth
- Wrench ready HEX shanks deliver additional leverage
- Chrome Plated- marine grade rust protection
- Multiple ID markings allow for quick tool identification on job site



Part #	Mfg #	Description	Price
163307	48-22-2402	2PC HollowCore Driver	

2 PC SAE HollowCore™ Magnetic Nut Driver Set

- HollowCore™ Unlimited depth- Ideal for long bolts or threaded rod application
- Magnetic drivers- Secure fitment in fastening applications
- Universal driver head fits 4X more fasteners
- Removes rusted and stripped bolts
- Color coded ID markings allow for quick tool identification on jobsite
- Wrench ready HEX shanks deliver additional leverage
- Chrome plated- Marine grade rust protection
- Forged steel shanks provide longer life and more durability
- Deep well sockets- drive multiple fasteners



Part #	Mfg #	Description	Price
162394	48-22-2502	2PC SAE HollowCore™ Magnetic Nut Driver Set	

Screwdrivers & Bits

7 PC Magnetic HollowCore™ SAE Nut Driver Set

- *HollowCore™ unlimited depth- ideal for long bolts or threaded rod applications*
- *Magnetic drivers- Secure fitment in fastening applications*
- *Universal driver head fits 4X more fasteners*
- *Removes rusted and stripped bolts*
- *Color coded ID markings allow for quick tool identification on jobsite*
- *Wrench ready HEX shanks deliver additional leverage*
- *Chrome plated- marine grade rust protection*
- *Forged steel shanks provide longer life and more durability*
- *Deep well sockets- Drive multiple fasteners*
- *Includes 9/16" driver*



Part #	Mfg #	Description	Price
161964	48-22-2507	7 PC Magnetic HollowCore™ SAE Nut Driver Set	



Screwdrivers & Bits

Screwdrivers

4-In-One Pocket Mini Screwdriver

- Includes:
 - 3/32" & 1/16" Slotted bit
 - #0 & #000 Phillips bit



Part #	Mfg #	Color	Price
136199	24008	Black/Yellow	

6-In-One Screwdriver

- Includes:
 - 1/4" & 3/16" Slotted bit
 - #1 & #2 Phillips bit
 - 1/4" & 5/16" Hex nut driver



Part #	Mfg #	Color	Price
028106	24006	Red	

Tools

Screwdrivers & Bits

Cushion Grip Screwdrivers

Stubby Heavy-Duty Square Shank Screwdriver - Keystone Tip



Part #	Mfg #	Shank Tip	Shank Length	Overall Length	Price
111152	600-1	1/4"	1-1/2"	3-7/16"	

Heavy-Duty Square Shank Screwdriver - Keystone Tip



Part #	Mfg #	Shank Tip	Shank Length	Overall Length	Price
107644	600-4	1/4"	4"	8-11/32"	

Round Shank Screwdriver - Cabinet Tip



Part #	Mfg #	Shank Tip	Shank Length	Overall Length	Price
107645	601-6	3/16"	6"	9-3/4"	
115682	601-10	3/16"	10"	13-3/4"	

Heavy-Duty Round Shank Screwdriver - Keystone Tip



Part #	Mfg #	Shank Tip	Shank Length	Overall Length	Price
107646	602-6	5/16"	6"	10-15/16"	

Miniature Cushion Grip Screwdriver - Phillips Tip



Part #	Mfg #	Tip Size	Shank Length	Overall Length	Price
120232	604-3	#0	3"	5-3/4"	

Miniature Cushion Grip Screwdriver - Cabinet Tip



Part #	Mfg #	Tip Size	Shank Length	Overall Length	Price
121303	607-3	3/32"	3"	5-3/4"	
121432	608-4	1/8"	4"	6-3/4"	

Stubby Round Shank Screwdriver - Profilated® Phillips Tip



Part #	Mfg #	Point Size	Shank Length	Overall Length	Price
111153	603-1	#2	1-1/2"	3-7/16"	

Round Shank Screwdriver - Profilated® Phillips Tip

- B - Wire bending



Part #	Mfg #	Point Size	Shank Length	Overall Length	Price
106813	603-4	#2	4"	8-5/16"	
114527	603-6	#3	6"	11"	
115681	603-10	#2	10"	14-5/16"	

Cushion Grip Screwdriver Sets

4-Piece Mini Cushion Grip Screwdriver Set

- Includes:
 - 604-3 Phillips tip #0
 - 606-2 Keystone tip 1/16"
 - 607-3 Cabinet tip 3/32"
 - 608-3 Cabinet tip 1/8"



Part #	Mfg #	Description	Price
106815	85484	4-Piece Mini Driver Set	

Tools

Screwdrivers & Bits

8-Piece Cushion Grip Screwdriver Set

- Includes (1) cabinet-tip, (3) keystone-tip, (4) Phillips-tip screwdrivers in styles:
 - 600-1
 - 601-3
 - 600-4
 - 602-6
 - 603-1
 - 603-3
 - 603-4
 - 603-6



Part #	Mfg #	Description	Price
113764	85078	8-Piece Set	

Screw-Holding Screwdrivers
Slotted Screw-Holding Screwdriver



Part #	Mfg #	Shank Tip	Shank Length	Overall Length	Price
106814	K36	1/4"	6"	9-3/4"	

Cushion Grip Nut Drivers

Stubby Nut Driver - 1-1/2" Hollow Shank

- Full hollow shank for long bolts or studs
- Meets or exceeds applicable AMSE/ANSI specifications



Part #	Mfg #	Size	Price
106819	610-1/4	1/4"	
106820	610-5/16	5/16"	

Magnetic Tip Stubby Nut Driver - 1-1/2" Hollow Shank

- Rare Earth magnetic tip
- Full hollow shank for long bolts or studs
- Meets or exceeds applicable AMSE/ANSI specifications



Part #	Mfg #	Size	Price
109254	610-1/4M	1/4"	
109255	610-5/16M	5/16"	

Magnetic Tip Nut Driver - 3" Hollow Shank

- Rare Earth magnetic tip
- Handle end is color-coded for easy identification
- Chrome-plated



Part #	Mfg #	Size	Price
109256	630-1/4M	1/4"	
109257	630-5/16M	5/16"	

Nut Driver - 3" Hollow Shank

- Standard length for most applications
- Fits over long bolts and studs



Part #	Mfg #	Size	Price
106818	630-1/4	1/4"	
106817	630-5/16	5/16"	
111184	630-3/8	3/8"	
111185	630-7/16	7/16"	
111183	630-1/2	1/2"	
111154	630-5/8	5/8"	

Magnetic Tip Nut Driver - 6" Hollow Shank

- Rare Earth magnetic tip
- Handle end is color-coded for easy identification
- Chrome-plated



Part #	Mfg #	Hex Size	Shaft Lgth	Price
110347	646-1/4M	1/4"	6"	
110346	646-5/16M	5/16"	6"	
112223	618-5/16M	5/16"	18"	

Cushion Grip Nut Driver Sets

Magnetic Tip Stubby Nut Driver Set - 1-1/2" Hollow Shank

- Full hollow shank for long bolts or studs
- Meets or exceeds applicable AMSE / ANSI specifications



Part #	Mfg #	Description	Price
125143	610M	1/4" & 5/16"	

Screwdrivers & Bits

Magnetic Tip Nut Driver Set - 3" Hollow Shank

- Rare Earth magnetic tip
- Cushion grip handle
- Color-coded handle end
- Internal flanges provide solid, twist-resistant shaft anchor
- Chrome-plated shaft helps prevent corrosion



Part #	Mfg #	Description	Price
125644	630M	1/4" & 5/16"	

Magnetic Tip Nut Driver Set - 6" Hollow Shank

- Rare Earth magnetic tip
- Handle end is color-coded for easy identification
- Chrome-plated



Part #	Mfg #	Description	Price
106816	646M	1/4" & 5/16"	

4-Piece Nut Driver Set - 3" Hollow Shank

- Color-coded handle end
- Cushion grip handle
- Chrome-plated
- Internal flanges provide solid, twist-resistant shaft anchor



Part #	Mfg #	Description	Price
141334	633	1/4", 5/16", 3/8" & 9/16"	

7-Piece Magnetic Tip Cushion Grip Nut Driver Set



Part #	Mfg #	Description	Price
111285	631M	3" Shank	

Screwdriver/Nut Driver Combinations

10-in-1 Screwdriver/Nut Driver

- End of handle is marked to quickly identify tool
- Includes:
 - 5/16" & 1/4" Nut drivers
 - #1 & #2 Phillips
 - 1/4" & 3/16" Slotted
 - #10 & #15 TORX®
 - #1 & #2 Square-recess
- Cushion grip handle



Part #	Mfg #	Description	Price
107643	32477	10-in-1 Screwdriver/Nut Driver	

11-in-1 Screwdriver/Nut Driver

- End of handle is marked to quickly identify tool
- Includes:
 - 3/8", 5/16" & 1/4" Nut drivers
 - #1 & #2 Phillips
 - 1/4" & 3/16" Slotted
 - #10 & #15 TORX®
 - #1 & #2 Square-recess
- Cushion grip handle



Part #	Mfg #	Description	Price
113299	32500	11-in-1 Screwdriver/Nut Driver	

10-Fold™ 10-in-1 Screwdriver/Nut Driver

- Folding pocket-style 10-in-1 tool with interchangeable bits - (8) screwdriver sizes and (2) nut drivers
- Unfolds and locks at a 180° angle to provide a straight screwdriver
- Blast finish steel bits provide a firm hold to the fastener to reduce cam-out
- Contains:
 - 5/16" & 1/4" Nut drivers
 - #1 & #2 Phillips
 - 1/4" & 3/16" Slotted
 - T10 & T15 TORX
 - #1 & #2 Square-recess



Part #	Mfg #	Description	Price
130688	32535	10-Blade Folding Screwdriver	

Tools

Screwdrivers & Bits

11-in-1 Screwdriver/Nut Driver with Valve Removal/ Installation Bit

- Includes a TR-4 Schrader® valve core installation/ removal and core extractor bit
- End of handle is marked to quickly identify tool
- Includes:
 - 3/8", 5/16" & 1/4" Nut drivers
 - #1 & #2 Phillips
 - 1/4" & 3/16" Slotted
 - #1 & #2 Square
 - Schrader valve core removal/ installation - extractor
- Cushion grip handle



Part #	Mfg #	Description	Price
130822	32527	11-in-1 Screwdriver/Nut Driver w/Schrader Valve Core Tool	

Magnetic Screwdriver with 32-Piece Bit Set

- Non-ratcheting screwdriver
- Tamperproof bit set in block includes:
 - TORX® - T7, T8, T10, T15, T20, T25, T27, T30, and T40
 - Fraction hex - 3/32" 7/64", 1/8", 9/64", 5/32", and 3/16"
 - Metric hex - 2mm, 2.5mm, 3mm, 4mm, and 5mm
 - Spanner - 4, 6, 8, and 10
 - Tri-Wing® - 1, 2, 3, and 4
 - TORQ-SET® - 6, 8, and 10
 - 1/4" Square to 1/4" hex adapter to drive sockets
- Cushion grip handle



Part #	Mfg #	Description	Price
114766	32510	Screwdriver w/32-Pc Bit Set	

Drill Bits

32-Piece Standard Tip Bit Set

- Chrome-plated
- Internal flanges
- Heat-treated shaft
- Precision-machined tip
- Patented Tip-Ident® quickly identifies the screwdriver type and tip orientation
- PVC Black block for storage
- Block slides over most screwdriver shafts for easy bit access and installation
- Industrial strength, heat-treated bits
- Includes:
 - Hex bits: 5/64", 3/32", 7/64", 1/8", 9/64", 5/32" and 3/16"
 - Phillips bits: #0, #1, #2, and #3
 - Square recess bits: #1, #2 and #3
 - TORX® bits: T6, T7, T8, T10, T15, T20 and T25
 - Slotted bits: 3-4, 5-6, 6-8, 8-10, 10-12, and 12-14
 - Clutch bits: 5/32" and 3/16"
 - 1/4" Square to 1/4" hex adapter to drive sockets

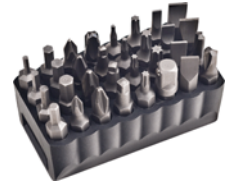

Part #	Mfg #	Description	Price
114768	32526	32-Piece Bit Set	



Sensible Products



Sensible Products

Screwdrivers & Bits

Slide Drivers

Slide Driver

- 1/4" Driver and 5/16" driver-in-one tool
- Magnetized



Part #	Mfg #	Description	Price
136605	SD-10	10" Length	

Bit Driver Slide Driver

- Fits into your drill
- Magnetized
- Thumb nut safety lock for slide driver
- 1/4" Driver and 5/16" driver-in-one tool



Part #	Mfg #	Description	Price
137282	SDBD-1	3" Length	

Screwdrivers & Bits

Power Bits

Phillips Bit



Part #	Mfg #	Description	Price
041954	S41-306	#2 Point, 1/4" Hex, 1" Long	

Screwdrivers & Bits

Screwdrivers & Bits

9 in 1 Multi-Tool

- Slip-resistant grip
- Thick-walled shaft
- Included:
 - Bits
 - Valve core remover
 - Square #2
 - 1/2" Hex
 - 5/16" Hex
 - 3/8" Hex
 - Phillips #1 & #2
 - 3/16" and 1/4" slotted



Part #	Mfg #	Description	Price
165766	1839053	9-in-1 Multi-Tool	

3" Shaft Magnetic Nut Drivers

- Secure hold
- Color-coded for quick identification
- Slip-resistant grip
- Hollowed shaft allows for use on long bolts
- Chrome-vanadium steel construction



Part #	Mfg #	Description	Price
171359	1839059	Red, 1/4" x 3"	
171360	1839060	Yellow, 5/16" x 3"	

6" Shaft Magnetic Nut Drivers

- Secure hold
- Color-coded for quick identification
- Slip-resistant grip
- Hollowed shaft allows for use on long bolts
- Chrome-vanadium steel construction



Part #	Mfg #	Description	Price
171362	1839068	Red, 1/4" x 6"	
171363	1839069	Yellow, 5/16" x 6"	
171364	1839074	Set of 2, 1/4" & 5/16"	

Precision Screwdriver Set

- Comfortable grips
- Maximum precision
 - Rotating head allows for precise adjustments
- Quick identification with easy-to-read tips
- Pouch included for storage
- Includes:
 - #0x3" Phillips, 1/16"x2", 3/32"x3", 1/8"x4", 1/8"x6" Slotted



Part #	Mfg #	Description	Price
174627	1891089	5-Pc Set	

Sheet Metal Tools

Snips for Metal and Vinyl

Max2000™ Aviation Snips

- An adjustable crossover disk assures an optimal length of cut that remains smooth and accurate
- Machined serrations on outside face of cutting edge
- Thicker, stronger steel handle resists abuse and will not collapse under normal use
- Length: 10-3/4"



M2001



M2002



M2003

Part #	Mfg #	Description	Price
032962	M2001	Cuts Left, Red Ergonomic Grip	
032963	M2002	Cuts Right, Green Ergonomic Grip	
032964	M2003	Combination, Yellow Ergonomic Grip	

Max2000™ Bulldog Aviation Snips

- Designed for notching and trimming
- Ideal for cutting multiple layers or "S" cleats



Part #	Mfg #	Description	Price
032965	M2005	Red Ergonomic Grip	

Max2000™ Offset Aviation Snips

- Cuts straight line and 5" diameter circles



M2006



M2007

Part #	Mfg #	Description	Price
036461	M2006	Cuts Offset Left, Red Ergonomic Grip	
036462	M2007	Cuts Offset Right, Green Ergonomic Grip	

Andy™ Classic Snips

- Suitable for mild curve cuts, straight shearing, or cutting multiple layers of sheet metal
- Lightweight aluminum handle
- 3" Cutting length



Part #	Mfg #	Description	Price
006451	M12A	12" Length	

Andy™ Pattern Snips

- Ground blade edge
- Suitable for mild curve cuts, straight shearing, or cutting multiple layers of sheet metal
- Lightweight aluminum handle
- Larger handle loops
- Extended blade tips
- 3-1/4" Cutting length



Part #	Mfg #	Description	Price
057978	M14N	14" Length	

Sheet Metal Tools

Awls

Scratch Awl

- High carbon alloy tool steel blade polished to resist rust
- May be re sharpened many times
- Easy-to-spot orange handles are shock and shatter resistant

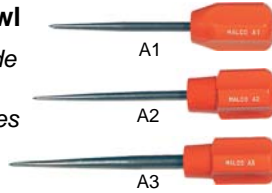

Part #	Mfg #	Blade Dia	Nom Length	Price
006370	A1	7/32"	5-3/4"	
006371	A2	1/4"	6-1/4"	
006373	A3	3/8"	7-1/2"	

Scribers

Pocket Size Sheet Metal Scriber

- Five teeth produce 10 scribing depths
- Compact scribe stores in pocket, pouch or tool box
- Use hang hole or magnet to keep handy on the job



Part #	Mfg #	Min/Max Adjustments	Price
038068	A40	1/8" - 1" Depths	

Adjustable Sheet Metal Scriber

- Measure, mark and scribe in one easy operation
- Depth up to 12-1/2"
- Compact design
- Durable construction
- Constructed of rust resistant nickel plated steel
- Knob assembly with hardened steel bolt insert will not strip out
- Uses Zip-In® sheet metal screw making point replacement easy



Part #	Mfg #	Min/Max Adjustments	Price
006376	A60	1/4" - 12-1/2" Depths	

Dividers

- Length: 11"
- Scratch awl points are easily re sharpened or replaced
- Nickel-plated steel body



Part #	Mfg #	Description	Price
006515	#18	32" Max Circle Diameter	
006522	#24	42" Max Circle Diameter	

Dividers (Continued)

Part #	Mfg #	Description	Price
021655	RP2	Divider Points for #18 and #27	

Folding Tools

- Folding seams are formed from two steel halves, permanently joined together



Part #	Mfg #	Width	Folding Depths	Price
006512	12F	12"	3/8" and 1"	
006516	18F	18"	3/8" and 1"	

Duct Tools and Accessories

Duct Stretcher

- Wheels can be changed to other side of tool for applications where side of duct is close to wall or obstruction



Part #	Mfg #	Description	Price
006386	DS1	16"	
006388	DS2	16" Offset Handle	
025654	DS3	12" Locking	

TurboShear™ Drills

TurboShear™

- Attaches to the chuck of a 1200 rpm, 12V cordless or an A/C electric drill
- Makes fast cuts in sheet metal
- Capable of making precise 6" x 6" square hole cuts
- 20 Gauge capacity in spiral duct
- 18 Gauge capacity in galvanized steel
- Material must be pre-set or held by an assistant
- Shear cuts to the left
- Use TSDC drill clamp for 1-hand operation



Part #	Mfg #	Description	Price
067222	TS1	TurboShear™ Sheet Metal Cutter	

Sheet Metal Tools

Hole Cutters

"Gold Standard" Hole Cutter

- Cuts holes up to 12" diameter in 20 gauge sheet metal
- Use with any standard 1/4" electric drill
- Cast aluminum body
- All wearing parts made of special heat-treated steel



Part #	Mfg #	Hole Diameter	Price
006408	HC1	2" - 12"	

REDLINE™ Hand Tools

5-Blade Pipe Crimper

- One-hand operation latch
- Soft-touch, non-slip handle insert
- Ergonomically contoured handles



Part #	Mfg #	Throat Depth	Price
131064	C5R	1-5/8"	

Hand Notcher

- One-hand operation latch
- Soft-touch, non-slip handle insert
- Ergonomically contoured handles
- Opening maximizes handle leverage



Part #	Mfg #	Throat Depth	Price
132797	N1R	13/16"	
132798	N2R	1"	

Hand Seamer with Forged Steel Jaw

- One-hand operation latch
- Soft-touch, non-slip handle insert
- Ergonomically contoured handles
- Opening maximizes handle leverage



Part #	Mfg #	Jaw Depth	Jaw Width	Price
132799	S2R	1-1/4"	3-1/4"	
132801	S6R	1-1/4"	6"	

Offset Hand Seamer with Forged Steel Jaw

- One-hand operation latch
- Soft-touch, non-slip handle insert
- Ergonomically contoured handles
- Opening maximizes handle leverage



Part #	Mfg #	Jaw Depth	Jaw Width	Price
132800	S3R	1-1/4"	3-1/4"	

Snap Lock Punch for Siding

- One-hand operation
- Ergonomic handles
- Opening maximizes handle leverage



Part #	Mfg #	Length	Throat Depth	Price
006483	SL1R	8"	3/8"	

Sheet Metal Tools

Crimpers

Single Crimper with Red Grip

- Fast, easy to use and lightweight
- Handy lock makes tool pocket sized
- Length: 8"



Part #	Mfg #	Throat Depth	Price
020268	SC1	1-1/4"	

Riveting Tools

2-in-1 Hand Riveter

- Adjustment features a single long stroke and a short ratchet action



Part #	Mfg #	Capacity	Price
006518	2-IN-1	1/8"-3/16" Rivet w/Steel Mandrel, 3/32- 5/32" Rivet w/SS Mandrel 8"Long	

Fiberglass Flex Duct Tools

Tensioning Tool

- Hardened steel stampings with weather resistant nickel chrome finish
- Vinyl grips with hand stops
- Tensioning adjustment knob and auto cut-off mechanism



Part #	Mfg #	Description	Price
006499	TY6	High Leverage Tie Tool, Auto Cut-Off	

Tie Tool

- Action tie tools feature long wearing, serviceable parts
- Comfortable handles reduce the pinch point area
- Works on all ties including thin designs



Part #	Mfg #	Description	Price
006498	TY4	Manual Cut-Off	

Flex Duct Cutter and Shear

- Double edged knife blade
- Thumb operated latch
- Easily resharpenable
- Handles feature non-slip vinyl grips



Part #	Mfg #	Description	Price
006389	FDC1	Flex Duct Cutter	

Tools

Sheet Metal Tools

Snips

Aviation Snips

- One handed locking
- Flush bolt design
- Forged alloy steel blades
- Hard chrome-plated blades reduces corrosion and protects against rust
- Serrated jaws
- Ergonomic handles



48-22-4010



48-22-4020



48-22-4030

Part #	Mfg #	Description	Price
150222	48-22-4010	Left Cutting	
150224	48-22-4020	Right Cutting	
150220	48-22-4030	Straight Cutting	

Offset Snips

- 45 Degree offset
- One handed locking - Ease of use/quick open & close
- Flush bolt design
- Forged alloy steel blades
- Rust protection - hard chrome plated blades increases tool life by reducing corrosion
- Serrated jaws - cuts: up to 18ga CRS (Cold rolled steel); 22ga SS (Stainless steel)
- Ergonomic handles



Part #	Mfg #	Description	Price
163181	48-22-4012	Left Cutting Offset Snips	
163182	48-22-4022	Right Cutting Offset Snips	
163183	48-22-4032	Straight Cutting Offset Snips	

Bulldog Snips

- One handed locking - ease of use quick open & close
- Flush bolt design
- Forged alloy steel blades
- Rust protection
- Serrated jaws - cuts up to 16ga CRS (Cold rolled steel); 18ga SS (Stainless steel)
- Ergonomic handles



Part #	Mfg #	Description	Price
163647	48-22-4000	Bulldog Snips	

Right Angle Snips

- One handed locking - ease of use/quick open & close
- Flush bolt design
- Forged alloy steel blades
- Rust protection - hard chrome plated blades increases tool life by reducing corrosion
- Serrated jaws - Cuts up to 24ga cold rolled steel; 28ga stainless steel
- Ergonomic handles



Part #	Mfg #	Description	Price
163488	48-22-4011	Left Cutting Right Angle Snips	
162739	48-22-4021	Right Cutting Right Angle Snips	

3-Piece Aviation Snips Set

- One-handed locking
- Flush bolt design
- Forged alloy steel blades
- Rust protection
- Serrated jaws cuts up to 18 gauge cold rolled steel and 22 gauge stainless steel
- Ergonomic handles
- Includes:
 - Straight cutting snips (48-22-4030)
 - Right cutting snips (48-22-4020)
 - Left cutting snips (48-22-4010)



Part #	Mfg #	Description	Price
147911	48-22-4033	3-Pc Aviation Snips Set	

Job site Straight Scissors

- Iron carbide edge blades
- Smooth blades for burr-free cuts
- All metal core
- Bolt lock technology
- Rust protection
- Large handle loops
- Ruler markings on blade
- Index finger groove



Part #	Mfg #	Description	Price
168966	48-22-4041	Job site Straight Scissors	



Sheet Metal Tools

Job site Offset Scissors

- Iron carbide edge blades
- Micro-Serrated blades for grip while cutting
- All metal core
- Bolt lock technology
- Rust protection
- Large handle loops
- Ruler markings on blade
- Index finger groove



Part #	Mfg #	Description	Price
168964	48-22-4040	Job site Offset Scissors	

Sheet Metal Tools

Sheet Metal Tools

5-Blade Crimper

- All steel construction and nickel-plating
- Produces indentations in stove pipe and round duct
- Crimps 24 gauge CRSM and 24 gauge SSSM



Part #	Mfg #	Handle Color	Length	Price
106830	86550	Blue	9"	

Hand Notcher

- Creates 30° "V"-shaped cuts in sheet metal
- Forged, high impact steel jaw with 13/16" maximum throat depth
- All steel construction with nickel-plated and black-oxide finish



Part #	Mfg #	Handle Color	Length	Price
106831	86551	Blue	8-1/2"	

Straight Hand Seamer - 3-1/4" Jaw

- For bending and flattening sheet and non-ferrous metals
- 3-1/4" Wide forged, high impact steel jaws are marked in 1/4" increments
- All steel construction and nickel-plated



Part #	Mfg #	Handle Color	Length	Price
106828	86553	Blue	8-3/8"	

Offset Hand Seamer

- Compound-leverage mechanism easily bends, seams and flattens sheet metal
- For use in overhead and confined areas
- Broader jaw model for forming wider folds
- Folds 22 gauge CRSM and 24 gauge SSSM
- Jaw marked in 1/4" (6 mm) increments for precise bending measurements
- Heavy-duty jaw/handle linkage for durability and easy operation
- All steel construction and nickel-chrome plated hardware
- Vinyl grips with handle stops



Part #	Mfg #	Handle Color	Length	Price
106829	86552	Blue	8"	

Offset Seamer Tong

- Hot drop-forged
- Bending depth indicators marked in 1/4" increments
- Bends 22 gauge CRSM
- Cushioned handles



Part #	Mfg #	Handle Color	Length	Price
108257	86554	Red	9-3/4"	

Folding Tool

- (2) Folding depths:
 - 3/8" (10mm)
 - 1" (925mm)
- Handy sight gauges
- Made of heavy-duty 16 gauge steel



Part #	Mfg #	Description	Price
108249	88980	12" Long	
108250	88981	18" Long	
108252	88982	24" Long	

Duct Stretcher

- Aligns and pulls ductwork together, easing installation of drive cleats
- Offset handle protects hand



Part #	Mfg #	OAL	Price
108255	89565	16"	

Sheet Metal Tools

Cutting and Notching Tools

Tinner Snips

- 6" Angled, hollow-ground cutting edge for cutting full 3-1/2" (89 mm) straight cuts and wide curves
- Easily replaceable cutting blades made of high-carbon steel
- Cutting capacity:
 - 22 Gauge cold-rolled sheet metal
 - 26 Gauge stainless steel sheet metal
- Not for use on hardened wire, nails, or any other rounded surface
- Lightweight magnesium handles



Part #	Mfg #	Handle Color	Length	Price
108246	3100	Gray	13"	

Snap Lock Punch

- Compound-leverage mechanism for greater control and easy operation
- Drop-forged steel jaw easily punches 3/8" (9.5mm) wide impressions on metal edges to easily join pieces of sheet metal, duct, or pipe
- All-steel construction and nickel-chrome plated hardware provide long life and durability
- Vinyl grips with handle stops for added comfort and easy operation



Part #	Mfg #	Handle Color	Length	Price
108254	86560	Blue	8"	

Cutting and Notching Snips

Journeyman Offset Snips

- Soft touch grips
- Klein Kurve® handles

JOURNEYMAN



J2100L



J2102S



J2101R



J2106S

Part #	Mfg #	Overall Length	Cutting Pattern	Color Code	Price
130818	J2100L	9-1/2"	Left/Str	Red/Blk	
130819	J2101R	9-1/2"	Right/Str	Grn/Blk	
130820	J2102S	9-1/2"	Straight	Yel/Blk	
130821	J2106S	10-1/2"	Straight Long Blade	Yel/Blk	

Aviation Snips



Part #	Mfg #	Overall Length	Cutting Pattern	Color Code	Price
106833	1100L	9-3/4"	Left	Red	
106832	1101R	9-3/4"	Right	Green	
108247	1102S	10-1/8"	Straight	Yellow	
106835	2100L	9-1/2"	Offset Left	Red	
106836	2101R	9-1/2"	Offset Right	Green	
108248	2102S	9-1/2"	Offset Str	Yellow	
106834	2103	9-1/4"	Notch	Yellow	

Tools

Sheet Metal Tools

Snips

Aviation Snips

- Long blade life
- Ultimate spring durability
- Quick identification



22102



22101



22103

Part #	Mfg #	Description	Price
102088	22101	Cuts Left	
104542	22102	Cuts Right	
103683	22103	Straight	

Offset Snips

- Long blade life
- Ultimate spring durability
- Quick identification



22206



22207

Part #	Mfg #	Description	Price
103680	22206	Cuts Left	
103681	22207	Cust Right	

Sheet Metal Tools

General Purpose Tools

Offset Snips

- 1-1/2" Cut length



796



797



Part #	Mfg #	Model	Description	Length	Price
017927	16202	796	Cuts Right	10-1/2"	
017926	16207	797	Cuts Left	10-1/2"	

Tools

Sheet Metal Tools

Sheet Metal Tools

Aviation Snips

- Comfortable grip
- High-carbon steel blades with reinforce chrome silicon spring
- Color-coded handle inserts and splines



Part #	Mfg #	Description	Price
177210	1891133	Aviation Snips Left Cut	
177211	1891134	Aviation Snip Right Cut	

Hand Seamers

- Comfortable grip
- High-carbon steel blades with reinforced chrome silicon spring
- Quick notification with 1/4" depth marks on blades



Part #	Mfg #	Description	Price
174605	1891183	3" Offset Hand Seamer	
174604	1891185	3" Hand Seamer	

Folding Tools

- Built for both 3/8" (10mm) and 1" (25mm) folds
- Equipped with sight holes for proper depth alignment



Part #	Mfg #	Description	Price
174607	1891146	12" Folding Tool	
174608	1890985	18" Folding Tool	
174610	1890986	24" Folding Tool	

Hole Cutters

- Lightweight aluminum frame, with a milled bit
- Inch and metric scales
- Fits into any corded or cordless drill with a 1/4" or larger chuck



Part #	Mfg #	Description	Price
175060	1891191	2" to 12" Hole Cutter	

Shovels

Shovels

Round Point Shovel with Long Handle

- 14 Gauge steel head and ferrule
- Shovel blades and shanks are 1-piece rustproof, taper-formed, then heat treated
- Handle length: 47"



Part #	Mfg #	Model	Blade Size	Price
008693	52300	170	8-5/8" x 11-1/2"	

Shovels

Heavy-Duty Commercial Shovels

Round Point Shovel with Long Fiberglass Handle

- 12 Gauge steel head and ferrule
- Closed back
- Wood reinforced fiberglass handle
- Handle length: 48-1/2"
- Overall length: 59-1/4"
- 100% American made



Part #	Mfg #	Description	Price
136120	92515	12ga Round Point Shovel	

Spades

Drain Spade D-Grip with Fiberglass Handle

- 12 Gauge steel head and ferrule
- Closed back
- Wood reinforced fiberglass handle
- Handle length: 32"
- Overall length: 40"
- 100% American made



Part #	Mfg #	Description	Price
136121	92535	12ga Drain Spade, Closed	

Floral & Speciality Shovels

Mud Shovel with Long Fiberglass Handle

- 14 Gauge steel head and ferrule
- Closed back
- Wood reinforced fiberglass handle
- Handle length: 48-1/2"
- Overall length: 59"
- 100% American made



Part #	Mfg #	Description	Price
136122	92705	14ga Mud Shovel, Closed	

Trunk Shovel with D-Grip Steel Handle

- 14 Gauge steel head and ferrule
- Closed back
- Steel handle
- Handle length: 24-1/2"
- Overall length: 32-3/4"
- 100% American made



Part #	Mfg #	Description	Price
147666	92712	14ga Trunk Shovel, Steel	

Trouble Lights/Extension Cords

Light Bulbs**Rough Service Light Bulb**

- *Multi-support filament*
- *Lasts twice as long as a standard bulb*
- *Frosted to reduce glare*



Part #	Mfg #	Description	Price
002314	8502	100 Watt Frosted	



Trouble Lights/Extension Cords

Work Lights

Fluorescent Trouble/Work Light

Part #	Mfg #	Description	Price
140727	D12812025	6' Orange Trouble Light with Grounded Outlet	

Trouble Lights/Extension Cords

Worklights

Magnetic Worklight

- *With hook and magnets*

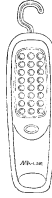

Part #	Mfg #	Description	Price
120538	MA-FL24LEDA	24 LEDs	

Tools

Trouble Lights/Extension Cords

Extension Cords

Orange Extension Cord

- 12/3 SJT
- Super heavy duty
- Outdoor/ Grounded
- Safety orange color



Part #	Mfg #	Description	Price
224081	E25005	12/3 SJT, 25 ft.	
224082	E25006	12/3 SJT, 50 ft.	

Shop Heater

- Fan forced wire element
- Three settings: 750/1500 watts
- Adjustable thermostat
- Wide stable base and adjustable tilt
- All metal body
- Long 6 ft. cord
- Padded carry handle
- Box: 10" x 7" x 11.5"



Part #	Mfg #	Description	Price
224080	H90101	Portable Shop Heater	

Work Lights

Trouble Light with Metal Cage

- Industrial quality
- 25 ft. cord
- 16/3 SJT
- 3-Prong side outlets
- Metal cage

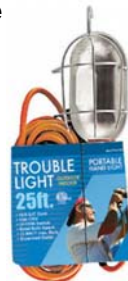

Part #	Mfg #	Description	Price
224083	E25021	16/3 SJT, 25 ft.	

Portable Halogen Work Light

- 500 Watt
- 6 ft. Grounded
- Power cord
- Adjustable frame



Part #	Mfg #	Description	Price
190131	E25250	6 ft Grounded, 500 Watt	

Wrenches

Wrenches

Heavy-Duty Straight Pipe Wrench

- Sturdy, cast iron housing and I-beam hand with full floating forged hook jaw, nonstick adjustment nut and replaceable hook and heel jaws



Part #	Mfg #	Model	Nom Size	Pipe Capacity	Price
008714	31010	10	10"	1-1/2"	
008686	31020	14	14"	2"	
008695	31025	18	18"	2-1/2"	
029928	31030	24	24"	3"	

Aluminum Handle Straight Pipe Wrench

- Nearly 40% lighter than comparable cast iron models of the same size
- Jaws and all other parts identical to RIDGID heavy-duty wrenches



Part #	Mfg #	Model	Nom Size	Pipe Capacity	Price
008768	31090	810	10"	1-1/2"	
054899	47057	812	12"	2"	
008770	31095	814	14"	2"	
008772	31100	818	18"	2-1/2"	
008774	31105	824	24"	3"	
026610	31115	848	48"	6"	

Aluminum Handle Offset Pipe Wrench

- Nearly 50% lighter than comparable cast iron models of the same size
- Features a jaw opening parallel to the handle and narrower hook jaw head which provides easy entry into tight spots



Part #	Mfg #	Model	Nom Size	Pipe Capacity	Price
022973	31125	18	18"	2-1/2"	

Strap Wrench

- Best for any polished pipe
- Strong, woven nylon strap gives tight grip
- Polyurethane-coated strap prevents scratching
- Replacement straps available



Part #	Mfg #	Model	Handle Length	Strap Length	Strap Width	Pipe Capacity	OD Tube Capacity	Price
008700	31340	2	11-3/4"	17"	1-1/8"	2"	3-1/2"	

Hex Wrench

- Gives multi-sided, secure grip on all hex nuts, square nuts, unions, and valve packing nuts



Part #	Mfg #	Model	Description	Nom Size	Pipe Capacity	Price
008571	31305	E110	Offset Hex	9-1/2"	1-1/8" - 2-5/8"	

Tools

Wrenches

Spud Wrench

- *Narrow jaws to fit into tight places*
- *Smooth, toothless jaws ideal for square or rectangular stock*



Part #	Mfg #	Size	Pipe Capacity	Price
008717	31400	12"	3/8" - 2-5/8"	

Adjustable Wrench

- *High strength forged, precision broached superior strength*
- *Wider and deeper jaws increased bite and grip surface*
- *Nickel plated superior corrosion resistance*
- *Acid etched scales English and metric readings*



Part #	Mfg #	Model	Nom Size	Pipe Capacity	Price
050314	86902	756	6"	3/4"	
050315	86907	758	8"	7/8"	
050323	86912	760	10"	1-1/8"	
050320	86917	762	12"	1-5/16"	

Basin Wrench

- *Spring-loaded jaws of forged alloy steel*
- *Tension plug holds head in any position up to 90° angle*



Part #	Mfg #	Model	Description	Nom Size	Pipe Capacity	Price
008658	31175	1017	Telescoping Basin	10" - 17"	3/8" - 1-1/4"	
022327	31180	1019	Telescoping Basin	10" - 17"	1-1/4" - 2-1/2"	

Faucet and Sink Installer (Plastic Nut Basin Wrench)

- *Designed to reach and turn plastic mounting nuts on faucets, sprayers and ballcocks*
- *Used to fasten and remove plastic basin nuts, supply line nuts, and 7/8" and 1" hex nuts*
- *Notched ends are designed to self-center on 2, 3, 4 and 6 tab nuts and to fit on metal hex nuts*
- *Strainer basket attachment holds drain unit in place while tightening strainer nut*
- *High strength plastic with aluminum inserts*



Part #	Mfg #	Model	Length	Price
034146	66807	2006	10-1/4"	

OneStop™ Wrench

- *(2) Tools in one*
- *Provides exact size surface wrenches needed for angle stop and compression coupling installation*



Part #	Mfg #	Model	Description	Price
065524	27023	2002	OneStop™ Wrench	

Tools

Wrenches

Wrench Parts



Part #	Mfg #	Description	For Model	Price
008614	31675	Heel Jaw & Pin Assembly	18, 818, E-18, S4A	

Tools

Wrenches

Wrenches

Aluminum Pipe Wrench



Part #	Mfg #	Size	Price
089135	23820-10ALPW	10"	
089136	23821-12ALPW	12"	
089137	23822-14ALPW	14"	
089138	23823-18ALPW	18"	
089139	23824-24ALPW	24"	

Heavy-Duty Cast Iron Pipe Wrench



Part #	Mfg #	Size	Price
096094	23813-10HDPW	10"	
096096	23814-12HDPW	12"	
096917	23815-14HDPW	14"	

Wrenches

Wrenches

Chrome Adjustable Wrench

- Longer jaws grip better, avoiding slippage or nut round off
- Measurement scales are handy for sizing nuts, pipe and tube diameters
- Greater jaw capacity supports larger nuts and bolts
- Thinner jaws for greater access in tight spaces
- Precise jaw design grips tight the first time
- Four thread knurl and non-protruding jaws provide greater capacity
- Minimal head width improves performance in confined spaces
- Chrome vanadium steel construction



Part #	Mfg #	Length	Capacity	Price
058194	R114800	4-1/2"	1/2"	
058195	R114900	6-1/4"	15/16"	
058196	R115000	8"	1-3/16"	
058197	R115100	10"	1-3/8"	
058198	R115200	12"	1-1/2"	

Code Blue® Adjustable Wrench

- Longer jaws grip better, avoiding slippage or nut round off
- Measurement scales are handy for sizing nuts, pipe and tube diameters
- Greater jaw capacity supports larger nuts and bolts
- Thinner jaws for greater access in tight spaces
- Precise jaw design grips tight the first time
- Four thread knurl and non-protruding jaws provide greater capacity
- Minimal head width improves performance in confined spaces
- Code Blue® grips are designed for durability and comfort



Part #	Mfg #	Length	Capacity	Price
117996	R115560	8"	1-1/2"	

Radiator Nipple Wrench

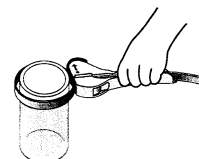

Part #	Mfg #	Description	Price
029136	R126145	Rubber Strap Wrench, 3/8" to 5-1/2"	

Drain Wrench

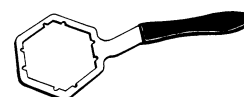

Part #	Mfg #	Description	Price
032867	R124710	Drain Wrench	

Tools

Wrenches

Adjustable Wrenches

Standard-Jaw Design Adjustable Wrench - Plastic Dipped Handles

- Plastic dipped handles
- Forged heat treated alloy steel for maximum strength and lightweight
- High polish chrome finish



Part #	Mfg #	Length	Capacity	Price
111292	D506-4	4-1/2"	1/2"	

Adjustable Wrench - Extra Capacity Plastic Handle

- Excellent in confined spaces
- High polish chrome finish



Part #	Mfg #	Length	Capacity	Price
112170	D507-6	6-3/8"	15/16"	
107650	D507-8	8-3/8"	1-1/8"	
106824	D507-10	10-3/8"	1-5/16"	
123781	D507-12	12-3/8"	1-1/2"	

Ratcheting Box Wrenches

Fully Reversible Ratcheting Refrigeration Wrench

- Fully reversible ratchet wrenches designed for refrigeration packing gland nuts and valve stem sockets
- Also designed for beam clamp installation
- Wrenches are compact in size, with clearly marked sockets for four nut sizes
- Chrome finish



Part #	Mfg #	Socket Sizes	Price
113965	68310	3/16" & 5/16" Square x 1/4" & 3/8" Square	

Ratcheting Box Wrench Sets

3-Piece Fully Reversible Ratcheting Offset Box Wrench Set

- Includes:
 - 68234 1/4" x 5/16"
 - 68236 3/8" x 7/16"
 - 68238 1/2" x 9/16"



Part #	Mfg #	Socket Sizes	Price
106827	68244	3-Piece Set	

L-Style Hex Keys Sets

- Long side for accessing hard-to-reach places
- Short side for higher torque situations and low clearances

12-Piece L-Style Hex Ball-End Caddy Set - Inch

- Includes:
 - BL2 .050"
 - BL4 1/16"
 - BL5 5/64"
 - BL6 3/32"
 - BL7 7/64"
 - BL8 1/8"
 - BL9 9/64"
 - BL10 5/23"
 - BL12 3/16"
 - BL14 7/32"
 - BL16 1/4"
 - BL20 5/16"



Part #	Mfg #	Description	Price
112667	BLK12	12-Piece Set - Inch	

Folding Hex Key Sets

9-Key Hex Set

- Sizes:
 - 5/64"
 - 3/32"
 - 7/64"
 - 1/8"
 - 9/64"
 - 5/32"
 - 3/16"
 - 7/32"
 - 1/4"



Part #	Mfg #	Description	Price
106826	70591	4-1/4" Length	

Wrenches

Ratchet Wrenches

Ratchet Wrench



- For installing or servicing heating, air conditioning or refrigeration units

Part #	Mfg #	Square	Hex	Price
006478	RRW3	3/16", 1/4", 5/16", 3/8"	-	

Hex Key Wrench Insert



Part #	Mfg #	Square	Hex	Price
006479	RRW3/16	1/4"	3/16"	

Hex Keys

Folding Hex Key Set

- Professional quality
- Produced from tough alloy steel



Part #	Mfg #	Description	Price
006503	W29	(9) Keys, Deluxe Pocket	

Wrenches

Razorback™ Wrench

- Remove shower and sink drains from top or bottom with just one hand
- T-Handle rotates 180°



Part #	Mfg #	Description	Price
093510	73055	Razorback™ Wrench	

Wrenches

Tools

Smart Dumbell®

- *Installs or removes drains without cross-bars (Kohler, American Standard)*
- *Heavy duty die-cast aluminum*
- *Prevents scratching of decorative finishes*
- *Use crescent wrench or large Phillips screwdriver to turn the tool*



Part #	Mfg #	Length	Price
008104	4554	6"	

Basin Wrenches

Eureka Cleanout Plug Wrench

- *Fits slotted or square countersunk cleanout plugs*
- *Strong, malleable iron*



Part #	Mfg #	Description	Price
083108	4567	Cleanout Plug Wrench	

Tools



Wrenches

Golden Tool™ Tools

Golden Grip® Internal Pipe Wrench

- *Installs or extracts pipe nipples from the inside*



Part #	Mfg #	Description	Price
080112	97250	Single 1/2"	

Golden Extractor™ Tub Drain Tool

- *Standard 3/8" drive ratchet to extract or install tub drains*



Part #	Mfg #	Description	Price
083657	97258	Universal Size	

Wrenches

Faucet Nut Splitter

- Splits old or new zinc or brass nuts in seconds
- Fits over all 1/2" faucet shanks
- Aluminum with a chisel tip of hardened tool steel



Part #	Mfg #	Description	Price
120323	NS-1	Faucet Nut Splitter	

Plumber's T-Handle Torque Tools

- Unique locking collar
- Slips internally when proper torque achieved



Part #	Mfg #	Socket	Type	in-lbs	Price
022114	2-SH	5/16"	Std No-Hub	60	

Wrenches

Plumbing Specialty Tools

4-Way Key

- For valves, faucets and sillcocks
- Plated steel



Part #	Mfg #	Sizes	Price
041932	J40-005	1/4", 9/32", 5/16" & 11/32"	

Extract-A-Drain Tub Drain Removal Tool

- Removes old or rusty drains
- Prevents damage to your tub's finish



Part #	Mfg #	Description	Price
057806	J40-018	Fits Both 1-1/4" & 1-1/2" Tub Drains	

Compression Sleeve Puller

- Removes leaking compression sleeves without damaging walls
- For 5/8" compression units



Part #	Mfg #	Description	Price
054587	J40-021	Comp Sleeve Puller, Carded	

Faucet Handle Puller

- Removes faucet and valve handles
- Plated steel



Part #	Mfg #	Description	Price
054584	J40-010	Standard Unit	

Wrenches

Element Wrench

- For removing heater elements
- Zinc-plated steel
- Individually bagged



Part #	Mfg #	Description	Price
041934	J36-101	Heavy-Duty	

No-Hub Torque Wrench

- Automatically releases at 60 in/lb
- Ratchets one way
- Built-in reversing lever
- Chrome vanadium socket



Part #	Mfg #	Description	Price
041933	T60-060	Domestic	

Basin Wrench

- 1-1/4" Jaw capacity



Part #	Mfg #	Description	Price
041935	B11-010	10" - 17" Telescoping	
227750	B11-012	9-1/2" - 16-1/2" Telescoping	

Radiator Spud Wrench

- For use as spud key and wrench



Part #	Mfg #	Description	Price
041936	J40-030	Plated Malleable Iron Wrench	

4-Way Plug Wrench



Part #	Mfg #	Description	Price
021060	J40-040	Countersunk Plug Wrench	

4-Way P.O. Plug Wrench

- For installing or removing basket strainers, tub drains and P.O. plugs



Part #	Mfg #	Description	Price
041937	J40-026	Wrench	

Wrenches

Moen® Stem & Cartridge Wrench

- Removes Moen® stems and cartridges
- Works on plastic/brass faucet/shower valves



Part #	Mfg #	Description	Price
054583	J45-015	Stem & Cartridge Wrench (Carded)	

Spanner/Strainer Wrench

- Used for basket strainer jam nuts



Part #	Mfg #	Description	Price
041941	J40-024	Plated Malleable Iron Wrench	

Do All Plumber's Wrench

- Longer, more comfortable handle
- Fits most standard size basket strainers including Opella, Duo, Twist Lock and PB Duo and any strainer which uses a standard 3-3/8" locknut
- Fits most shower stall drains

Part #	Mfg #	Description	Price
054595	J40-019	Do All Plumber's Wrench (Carded)	

Universal Drain Wrench

- Die cast aluminum
- Installs and removes tub drains and closet spuds
- Use crescent wrench or screwdriver to turn tool



Part #	Mfg #	Description	Price
050424	J45010	6" Long	



Sensible Products



Sensible Products

Wrenches

Fan Blade & Blower Wheel Pullers

- Removes fan blades/blower wheels that are frozen to a motor shaft
- Can be used to apply pushing or pulling force
- Includes (4) pulling hooks and (3) set screws
- Accommodates 5/8" belt drive and 1/2" or less direct drive motor shafts



Part #	Mfg #	Description	Price
136604	UP-1	"The Ultimate Puller"	

Tools

Aluminum Venting

**Aluminum Duct
Aluminum Pipe**



Part #	Size	Price
014515	3" x 24"	
015382	4" x 24"	
075826	4" x 60"	
015709	6" x 24"	

Aluminum Elbow

- Box quantity: 12



Part #	Size	Price
014306	3"	
015192	4"	
015617	6"	

Venting

Aluminum Venting

Ventilation Products

Versa Cap™ Flue and Hot Stack Cap

- *Non-clogging positive draft design*
- *Adjustable clamp fitting*
- *UL Listed*



Venting

Part #	Mfg #	Pipe OD	Single Wall	Price
006171	6-3050	2-7/8" - 5"	3" & 4"	
006172	6-5070	4-7/8" - 7"	5" & 6"	
006173	6-7090	6-7/8" - 9"	7" & 8"	
006170	6-1200	11-7/8" - 14-1/2"	12" & 14"	

Chimney Liners

Metalbest Flexible Aluminum Chimney Liner Kits

- Solution for gas-fired heat venting
- Eliminates chimney flue deterioration
- Aluminum Liner Kit includes:
 - 2-Ply Aluminum Flexi-liner
 - Round top (RV)
 - Flashing with 3" collar
 - Motor guard



Part #	Part #	Size	Length	Price
031689	AF25-03	3"	25'	
031800	AF35-03	3"	35'	
015210	AF25-04	4"	25'	
020303	AF35-04	4"	35'	
020304	AF35-05	5"	35'	
020305	AF35-06	6"	35'	

Venting

Draft Diverters

Galvanized Diverters
Galv Vertical Draft Diverter



Part #	Size	Price
011100	8"	

Venting

Dryer Venting

Dryer Venting

Aluminum Elbow & Pipe

- All aluminum



Part #	Mfg #	Description	Price
051185	D04-027	4" x 90° Swivel Elbow	
051184	D04-028	4" x 24" Pipe	

Vinyl Vent Hose

- Wire reinforced vinyl



Part #	Mfg #	Size	Price
015494	D04-050	4" x 50'	

Aluminum Vent Hood

- For clothes dryers or exhaust fans
- Complete with damper and flange plate



Part #	Mfg #	Size	Price
007995	D04-024	4"	

Louvered Dryer Vent Hood

- Includes:
 - Hood
 - Aluminum pipe
 - Collar

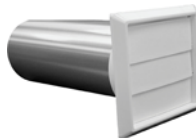

Part #	Mfg #	Size	Color	Price
046324	D04-025	4"	White	
046325	D04-026	4"	Brown	

Dryer Vent Hood

- PVC
- Weather proof 12" aluminum extension
- Pre-punched mounting holes

Part #	Mfg #	Size	Price
081179	D04-012	4"	

Metal Clamp for Dryer Vent

- Heavy-duty all metal design
- Excellent for use with metal ducting



Part #	Mfg #	Size	Price
014355	D04-015	3"	
015229	D04-016	4"	

Dryer Duct

Flexible Aluminum Foil Ducting

- Ideal for exhausting clothes dryers and bathroom fans
- Will not support combustion
- No fire or UL ratings



Part #	Mfg #	Size	Price
090879	D04-057	4" x 8'	

Flexible Aluminum Ducting

- Ideal for exhausting clothes dryers
- Bendable to any configuration



Part #	Mfg #	Size	Price
030873	D04-054	4" x 25'	

Dryer Venting

Wall Vents**Louver Hood Faceplate**

Part #	Mfg #	Description	Price
097306	20328	6" White Hood, 12/Pk	

Mini Louver Fresh Air Intake

- Plastic
- Screens are 1/4" x 1/4" molded grid
- Fixed louvers
- Works for thru-wall as well as eave venting

Part #	Mfg #	Description	Price
097307	20332	6" White Fresh Air Intake	

Venting

Exhaust Fans

WhisperGreen® Ventilating Fans

WhisperGreen® Fan with Built-In Control

- Continuous and spot ventilation
- Constant CFM - built-in intelligence performs at a constant CFM regardless of elbows and other factors - when the fan faces static pressure, it automatically increases speed to reach desired CFM
- Variable speed control - CustomVent™ allows fan to run continuously at a pre-set lower level of 30-70 CFMs that can be elevated to a maximum of 80 CFMs when the switch is turned on and turn (or via SmartAction™ Motion Sensor) - high/low delay timer (adj from 30 seconds to 60 minutes) returns fan to the minimum CFM level
- Built-in damper prevents backdraft
- Energy Star® rated



Part #	Mfg #	CFM	Options	Price
140061	FV-08VKM3	30 - 80	Motion Sensor	
130694	FV-13VKM3	0 - 130	Motion Sensor	

**WhisperGreen Select™ Ventilating Fans
One Fan - Multiple IAQ Solutions**

- Pick-A-Flow speed selector
- Plug 'N Play modules allow further customization
- Features a DC Motor with SmartFlow® technology
- Flex-Z Fast installation bracket
- Power rating: 120 volts and 60 Hz



Part #	Mfg #	CFM	Noise (Sones)	Price
170246	FV-05-11VK1	50 - 113	<0.3	
170245	FV-11-15VK1	110-150	<0.7	

WhisperGreen Select™ - With Built-in LED Lights



Part #	Mfg #	CFM	Noise (Sones)	Price
170014	FV-05-11VKL1	50-110	<0.3	
170244	FV-11-15VKL1	110-150	<0.9	

WhisperGreen Select™ - Multi-Speed



Part #	Mfg #	CFM	Noise (Sones)	Price
173493	FV-05-11VKS1	50-110	<0.3	

WhisperGreen Select™ - Multi-Speed w/ LED Lights



Part #	Mfg #	CFM	Noise (Sones)	Price
173964	FV0511VKS1	50-110	<0.3	

**WhisperGreen® Ventilating Fan
Single Speed**

- SmartFlow™ technology for optimal CFM output
- Fully enclosed DC motor for long life – rated for 60,000 hours continuous run
- Detachable dual 4" or 6" duct adaptor included
- Fits in 2 x 8 construction
- Energy Star® rated



Part #	Mfg #	CFM	Noise (Sones)	Price
139499	FV-08VK3	80	<0.3	

WhisperCeiling™ Ventilating Fans

- Low noise levels
- Low power consumption
- Long run times or continuous operation
- Built-in damper prevents backdraft
- Energy Star® rated



Part #	Mfg #	CFM	Noise (Sones)	Price
133291	FV-08VQ5	80	<0.3	

Venting

Exhaust Fans

Venting

**WhisperGreen® Ventilating Fans
(Continued)**

WhisperCeiling™ Ventilating Fans

Part #	Mfg #	CFM	Noise (Sones)	Price
134328	FV-11VQ5	110	<0.3	
133419	FV-15VQ5	150	<0.3	

WhisperWall™ Ventilating Fan

- Through-the-wall installation
- Low noise levels
- Low input wattage



Part #	Mfg #	CFM	Noise (Sones)	Price
132993	FV-08WQ1	70	1.1	

WhisperFit-Lite™ Low Profile Fan/Light/Night-Light

- Optional 3" duct adapter is included
- (2) 18W Compact fluorescent lamps provide overhead lighting
- 4-Watt night-light
- Energy Star® rated



Part #	Mfg #	CFM	Noise (Sones)	Price
136613	FV-05VFL2	50	0.3	
130047	FV-08VFL2	80	0.5	

WhisperLite™ Fan/Light

- Low noise level
- Low power consumption
- Long run times or continuous operation
- Energy Star® rated



Part #	Mfg #	CFM	Noise (Sones)	Price
133293	FV-08VQL5	80	<0.3	
133417	FV-11VQL5	110	0.5	
133418	FV-15VQL5	150	0.9	

WhisperWarm™ Fan/Heater/Light/Night- Light

- Low noise level
- 30.6W Power consumption
- 1400W Heating element
- 25W Heater fan
- For 4" duct size
- Night light feature
- (2) 18W Compact fluorescent bulb
- UL Listed



Part #	Mfg #	CFM	Noise (Sones)	Price
133063	FV11VHL2	110	0.7	

WhisperValue™ Super Low Profile Ventilating Fan



Part #	Mfg #	CFM	Noise (Sones)	Price
231574	FV-0510VS1	50	1.0	
137770	FV-08VS1	80	1.5	

Exhaust Fans

WhisperValue™ Super Low Profile Ventilation Fan/Light

- Energy Star® rated



Part #	Mfg #	CFM	Noise (Sones)	Price
134285	FV-08VSL1	80	1.5	

WhisperFit™ EZ Fan

- The fastest, easiers, retrofit, ENERGY STAR® fan available
- Built-In Pick-A-Flow™ speed selector
- Flex-Z Fast™ Installation bracket
- Low profile 5-5/8" housing depth fits in 2x6 construction



Part #	Mfg #	CFM	Noise (Sones)	Price
177128	FV-08-11VF5	80-110	1.5	

WhisperFit™ EZ Fan with Light

- The fastest, easiers, retrofit, ENERGY STAR® fan available
- Built-In Pick-A-Flow™ speed selector
- Flex-Z Fast™ Installation bracket
- Low profile 5-5/8" housing depth fits in 2x6 construction



Part #	Mfg #	CFM	Noise (Sones)	Price
177130	FV-08-11VFL5	80-110	1.5	

WhisperFit™ EZ Fan with SmartAction® Motion Sensor

- Motion sensor with 20 min delay off timer automatically activates fan when someone enters room
- The fastest, easiers, retrofit, ENERGY STAR® fan available
- Built-In Pick-A-Flow™ speed selector
- Flex-Z Fast™ Installation bracket
- Low profile 5-5/8" housing depth fits in 2x6 construction



Part #	Mfg #	CFM	Noise (Sones)	Price
177129	FV-08-11VFM5	80-110	1.5	

WhisperRecessed LED™ Fan/Light Combo

- Incorporates a powerfule, yet quiet 80 CFM fan behind an elegant recessed LED light
- Includes a dimmable 14W GU24 base LED lamp
- 6-1/2" Aperture and advanced luminaire design
- Adjustable lamp positional



Part #	Mfg #	CFM	Noise (Sones)	Price
231495	FV-08VRE2	80 CRM	<0.8	

WhisperGreen-Lite™ Ventilating Fans

Single-Speed WhisperGreen-Lite™ Fan

- Built-in intelligence allows fan to perform at a constant CFM regardless of elbows and other factors that might hinder performance
- Electronic ballast technology with (2) Energy-Star® qualified 18W compact, flicker-free fluorescent lamps and a 4W night-light
- Built-in damper to prevent backdraft
- Energy Star® rated



Part #	Mfg #	CFM	Noise (Sones)	Price
139924	FV-08VKL3	80	<0.3	

Venting

Exhaust Fans

Venting

Variable-Speed WhisperGreen-Lite™ Fan

- Built-in intelligence allows fan to perform at a constant CFM regardless of elbows and other factors that might hinder performance
- Electronic ballast technology with (2) Energy-Star® qualified 18W compact, flicker-free fluorescent lamps and a 4W night-light
- Variable speed control - CustomVent™ allows fan to run continuously at a pre-set lower level of 30-70 CFMs that can be elevated to a maximum of 80 CFMs when the switch is turned on and turn (or via SmartAction™ Motion Sensor) - high/low delay timer (adj from 30 seconds to 60 minutes) returns fan to the minimum CFM level
- Built-in damper to prevent backdraft
- VKML Suffix - Motion Sensor
- Energy Star® rated



Part #	Mfg #	Duct	CFM	Noise (Sones)	Price
137705	FV-08VKML3	4" or 6"	80	<0.3	
139800	FV-13VKML3	6"	130	<0.3	

EcoVent Ventilating Fans

EcoVent™ Fan with Veri-Boost™ Cost Effective, Spot Ventilation Solution

- 70 CFM fan delivers strong performance w/ peace of mind
- Built-In Veri-Boost™ switch provides a 20 CFM boost when needed
- Small grille design



FV-07VBA1 - Fan Housing
FV-07VBB1 - Motor/Grille Assembly
(Both required to complete unit)

Part #	Mfg #	Description	Price
170242	FV-07VBA1	Housing Can, Duct Adaptor, & Junction Box	
170241	FV-07VBB1	Motor & Grille	

Switches

Multi-Function Control WhisperControl Switch

- Multi-switch combination saves space and adds convenience
- Common feed shunted internally to all switches
- Includes matching wall plate
- Commercial grade
- Elegant styling provides multiple controls in a single-gang wall box
- 4-Function control - single pole/double throw on-off-on top switch, two single pole on-off switches



Part #	Mfg #	Color	Functions	Price
163969	FV-WCSW31-W	White	3	
145404	FV-WCSW41-W	White	4	

WhisperControl Condensation Sensor

- Automatically turns on when relative humidity and temperature change is detected
- 30 Minute countdown timer
- Manual On/Off control
- Compatible with single-speed fans or fan/lights
- Stylish design with wall plate included
- LED Indicator
- Energy Star®, LEED for Homes, ASHRAE 62.2, and CALGreen compliant
- 1-Year limited warranty



Part #	Mfg #	Color	Description	Price
144623	FV-WCCS1-W	White	On/Off	
148246	FV-WCCS1-A	Light Almond	On/Off	
145403	FV-WCCS2-W	White	On/Off/Light	

Parts & Accessories

WhisperGreen Select™ Condensation Sensor Plug 'N Play Module

- Helps prevent mold and mildew
- Sensor detects relative humidity and temperature to anticipate dew point, automatically turning the fan on to control humidity
- Humidity (RH) sensitivity adjustment enables fine tuning for moist conditions and for satisfying CALGreen requirements
- Activates a 20 minute delay off timer for the fan

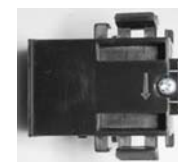

Part #	Mfg #	Description	Price
170250	FV-CSVK1	Condensation Sensor	

Exhaust Fans

WhisperGreen Select™ SmartAction® Motion Sensor Plug 'N Play Module

- Automatically activates when someone enters the room
- Once the settings have been applied, the fan becomes truly automatic
- This module also activates a 20 minute delay off timer for the fan



Part #	Mfg #	Description	Price
170248	FV-MSVK1	Motion Sensor	

WhisperGreen Select™ NiteGlo™ LED Light Plug 'N Play Module

- A photocell automatically turns on the 1 watt LED night light when darkness is sensed in the room
- High/Low brightness switch enables you to fine tune the photocell to work in conjunction with the darkness level of your bathroom
- This module also activates an automatic 20 minute delay off timer for the fan



Part #	Mfg #	Description	Price
170249	FV-NLVK1	NigtGlo LED Night Light	

WhisperGreen Select™ Multi-Speed with Time Delay Plug 'N Play Module

- Allows you to select the proper CFM settings to satisfy ASHRAE 62.2 continuous ventilation requirements
- High/Low delay timer returns the fan to the preset CFM level after a period of time set by the user
- The fan runs continuously at a preset lower level (0, 30-100 or 0, 50-120 CFM, in 10 CFM increments), then elevates to a maximum level of operation (50-80-110 or 110-130-150 CFM) when the wall switch is turned on, or when the motion sensor or condensation sensor module is activated



Part #	Mfg #	Description	Price
170247	FV-VS15VK1	Multi-Speed w/ Time Delay	

Venting

Exhaust Fans

Quantum Inline Fans

Quantum Ventilation System

- Complete exhaust system includes:
 - Inline plastic combi- fan
 - Multi-position metal bracket
 - Duct connection collar
- Capable of multi-point exhaust
- Energy Star® rated



Venting

Part #	Mfg #	Description	Price
080159	99-NBQ-COMBI	4", 5", 6" , 180/240/270 CFM, 3-in-1 Inline System, White	

Outside Air Venting

Make-Up Air Controls

216 Self-Adjusting Make-Up Air Control

Appropriate for all Warm-Air Heating Systems

- *Combats interior air pollution*
- *Reduces drafts and uncontrolled air infiltration to provide year-round comfort*
- *Improves furnace efficiency*
- *Durable, corrosion-resistant stainless steel construction*
- *Includes 6" inlet hood*



Part #	Mfg #	Dia	Hood Size	Price
020915	216-1	6"	6"	

Plastic High Temperature Sealants

Silicone Sealants

100% Silicone Sealant Squeeze Tube

- 100% silicone
- Will not crack, shrink or peel
- Interior/exterior use
- Solvent clean-up, not paintable



Venting

Part #	Mfg #	Size	Color	Price
128598	0810	2.8 fl oz	White	
008384	0820	2.8 fl oz	Clear	

Plastic High Temperature Sealants

Silicone Caulk

Silicone Construction Caulk

- For indoor or outdoor use
- Permanently flexible
- -60°F - +450°F Water and weatherproof
- Insulates electrically and thermally room temperature vulcanizing



Part #	Mfg #	Description	Price
059844	12W	10.3 oz, White	
059845	12C	10.3 oz, Clear	

Silicone Seal Carded

- For indoor or outdoor use
- Permanently flexible
- -60°F - +450°F Water and weatherproof
- Insulates electrically and thermally room temperature vulcanizing



3W



3C

Part #	Mfg #	Description	Price
059842	3W	3 oz, White Mildew Resistant FDA/NSF	
059843	3C	3 oz, Clear USDA/FDA/NSF	

Venting



Power Venters

Draft Inducers

- *Inline Auto-Draft® inducers*
- *Quick and easy to install*
- *Vari-Draft control permits adjustments to the individual job requirement*
- *115V 60Hz*

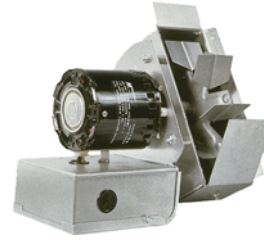

Venting

Part #	Mfg #	Smokepipe Size	RPM	Watts	Amps	HP Open	Price
010374	D-3	5" - 8"	1,550 rpm	74W	.96A	1/20 hp	

QC Venting

Venting

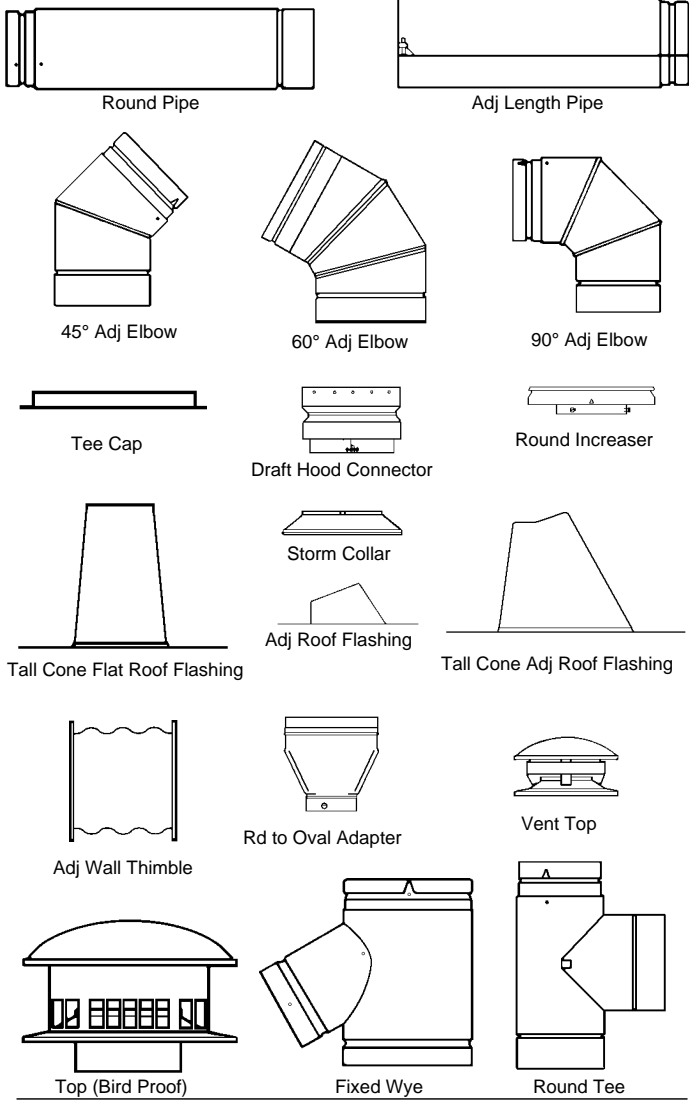

12" Gas Vent Round

Part #	Mfg #	Description	Price
008345	12QC-18	18" Round Pipe	
008346	12QC-30	30" Round Pipe	
008372	12QC-45	45° Fixed Elbow	
008337	12QC-AF	Adj Roof Flashing	
008364	12QC-RT	Top	
008352	12QC-SC	Storm Collar	
008358	12QC-TC	Tee Cap	
008362	12QC-TF	Tall Cone Flat Roof Flashing	
008368	12QC-TS	Tee	

14" Gas Vent Round

Part #	Mfg #	Description	Price
008348	14QC-30	30" Round Pipe	
008373	14QC-45	45° Fixed Elbow	
008338	14QC-AF	Adj Roof Flashing	
008365	14QC-RT	Top	
008353	14QC-SC	Storm Collar	
008359	14QC-TC	Tee Cap	
008355	14QC-TF	Tall Cone Flat Roof Flashing	
008369	14QC-TS	Tee	

16" Gas Vent Round

Part #	Mfg #	Description	Price
008350	16QC-30	30" Round Pipe	
008339	16QC-AF	Adj Roof Flashing	
008366	16QC-RT	Top	
008354	16QC-SC	Storm Collar	
008356	16QC-TF	Tall Cone Flat Roof Flashing	

Type "B" Gas QC Vent Pipe & Fittings

10" Gas Vent Round

Part #	Mfg #	Description	Price
008343	10QC-18	18" Round Pipe	
008344	10QC-30	30" Round Pipe	
008371	10QC-45	45° Fixed Elbow	
008336	10QC-AF	Adj Roof Flashing	
008340	10QC-AJ	18" Adj Length Pipe	
008363	10QC-RT	Top	
008351	10QC-SC	Storm Collar	
008357	10QC-TC	Tee Cap	
008361	10QC-TF	Tall Cone Flat Roof Flashing	
008367	10QC-TS	Tee	

RV Round Venting

Venting

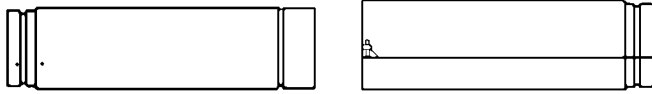

Round Pipe

Adj Length Pipe

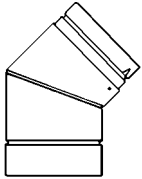

45° Adj Elbow

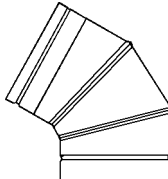

60° Adj Elbow

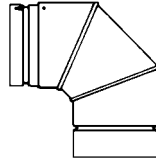

90° Adj Elbow

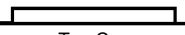

Tee Cap

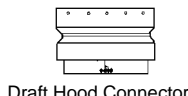

Draft Hood Connector

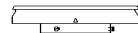

Round Increaser

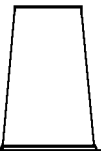

Tall Cone Flat Roof Flashing

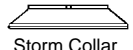

Storm Collar

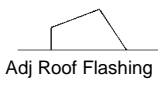

Adj Roof Flashing



Tall Cone Adj Roof Flashing

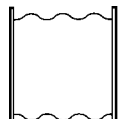

Adj Wall Thimble

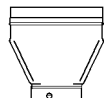

Rd to Oval Adapter

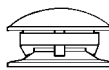

Vent Top

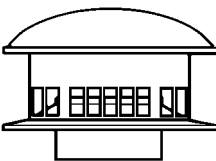

Top (Bird Proof)

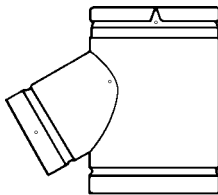

Fixed Wye

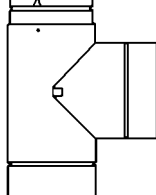

Round Tee

Type "B" Gas RV Vent Pipe & Fittings

3" Gas Vent Round

Part #	Mfg #	Description	Price
009690	3RV-6	6" Round Pipe	
009685	3RV-12	12" Round Pipe	
009686	3RV-18	18" Round Pipe	
009687	3RV-2	24" Round Pipe	
009688	3RV-3	36" Round Pipe	
066532	3RV-4	48" Round Pipe	
009689	3RV-5	60" Round Pipe	
052598	3RV-60	45°/60° Adjustable Elbow	
009790	3RV-90	90° Adjustable Elbow	
009657	3RV-AF12	Adj Roof Flashing 6/12 to 12/12	
009676	3RV-AJ	12" Adj Length Pipe	
009663	3RV-DH	Draft Hood Connector	

Type "B" Gas RV Vent Pipe & Fittings (Continued)

3" Gas Vent Round

Part #	Mfg #	Description	Price
009774	3RV-FSPU	3" Quick Grip Firestop/Spacer	
053951	3RV-HWT	High Wind Top	
009668	3RV-I4	3" x 4" Increaser	
009669	3RV-I5	3" x 5" Increaser	
096904	3RV-I6	3" x 6" Increaser	
009760	3RV-RT	Vent Top	
009729	3RV-SC	Storm Collar	
009748	3RV-TC	Tee Cap	
009754	3RV-TF	Tall Cone Flat Roof Flashing	
009653	3RV-TFA	Tall Cone Adj Roof Flashing	
009766	3RV-TS	Tee	
043482	3RV-WT	Adj Wall Thimble	

4" Gas Vent Round

Part #	Mfg #	Description	Price
009696	4RV-6	6" Round Pipe	
009691	4RV-12	12" Round Pipe	
009692	4RV-18	18" Round Pipe	
009693	4RV-2	24" Round Pipe	
009694	4RV-3	36" Round Pipe	
041120	4RV-4	48" Round Pipe	
009695	4RV-5	60" Round Pipe	
009675	4RV-3RA	3" Rheem Adapter	
009794	4RV-90	90° Adjustable Elbow	
009658	4RV-AF12	Adj Roof Flashing 6/12 to 12/12	
009677	4RV-AJ	12" Adj Length Pipe	
009678	4RV-AJ18	18" Adj Length Pipe	
009664	4RV-DH	Draft Hood Connector	
052600	4RV-EL45/60	45°/60° Adjustable Ell	
009775	4RV-FSPU	4" Quick Grip Firestop/Spacer	
053952	4RV-HWT	Hi-Wind Cap	
009670	4RV-I5	4" x 5" Increaser	
009671	4RV-I6	4" x 6" Increaser	
009761	4RV-RT	Top Vent (Bird Proof)	
009730	4RV-SC	Storm Collar	
009749	4RV-TC	Tee Cap	
009755	4RV-TF	Tall Cone Flat Roof Flashing	
009654	4RV-TFA	Tall Cone Adj Roof Flashing	
009767	4RV-TS	Tee	
037624	4RV-WT	Adj Wall Thimble	
009779	4RV-WV4	Round to Oval Adapter	

RV Round Venting

5" Gas Vent Round

Part #	Mfg #	Description	Price
009702	5RV-6	6" Round Pipe	
009697	5RV-12	12" Round Pipe	
009698	5RV-18	18" Round Pipe	
009699	5RV-2	24" Round Pipe	
009700	5RV-3	36" Round Pipe	
041121	5RV-4	48" Round Pipe	
009701	5RV-5	60" Round Pipe	
009783	5RV4-FY	4" Fixed Wye s/4" Snout	
114028	5RV43FY	5" x 4" x 3" Fixed Wye	
009780	5RV-5/6WV	Round to Oval Adapter	
052601	5RV-60	45°/60° Adjustable Elbow	
009795	5RV-90	90° Adjustable Elbow	
009655	5RV-AF	Adj Roof Flashing Flat to 6/12	
009659	5RV-AF12	Adj Roof Flashing 6/12 to 12/12	
009679	5RV-AJ	12" Adj Length Pipe	
009680	5RV-AJ18	18" Adj Length Pipe	
009665	5RV-DH	Draft Hood Connector	
009776	5RV-FSPU	5" Quick Grip Firestop/Spacer	
053953	5RV-HWT	Hi-Wind Top	
009672	5RV-I6	5" x 6" Increaser	
009762	5RV-RT	Vent Top	
009731	5RV-SC	Storm Collar	
009750	5RV-TC	Tee Cap	
009756	5RV-TF	Tall Cone Flat Roof Flashing	
009768	5RV-TS	Tee	

6" Gas Vent Round

Part #	Mfg #	Description	Price
009708	6RV-6	6" Round Pipe	
009703	6RV-12	12" Round Pipe	
009704	6RV-18	18" Round Pipe	
009705	6RV-2	24" Round Pipe	
009706	6RV-3	36" Round Pipe	
009707	6RV-5	60" Round Pipe	
009781	6RV-5/6WV	Round to Oval Adapter	
052602	6RV-60	45°/60° Adjustable Elbow	
009796	6RV-90	90° Adjustable Elbow	
009656	6RV-AF	Adj Roof Flashing Flat to 6/12	
009660	6RV-AF12	Adj Roof Flashing 6/12 to 12/12	
009681	6RV-AJ	12" Adj Length Pipe	
009666	6RV-DH	Draft Hood Connector	
009777	6RV-FSPU	6" Quick Grip Firestop/Spacer	
053954	6RV-HWT	Hi-Wind Cap	
009673	6RV-I7	6" x 7" Increaser	
009674	6RV-I8	6" x 8" Increaser	

Type "B" Gas RV Vent Pipe & Fittings (Continued)

6" Gas Vent Round

Part #	Mfg #	Description	Price
009763	6RV-RT	Vent Top	
009732	6RV-SC	Storm Collar	
009751	6RV-TC	Tee Cap	
009757	6RV-TF	Tall Cone Flat Roof Flashing	
009769	6RV-TS	Tee	

7" Gas Vent Round

Part #	Mfg #	Description	Price
009714	7RV-6	6" Round Pipe	
009709	7RV-12	12" Round Pipe	
009710	7RV-18	18" Round Pipe	
009711	7RV-2	24" Round Pipe	
009712	7RV-3	36" Round Pipe	
009713	7RV-5	60" Round Pipe	
009788	7RV-45	45° Adjustable Elbow	
009797	7RV-90	90° Adjustable Elbow	
009661	7RV-AF	Adj Roof Flashing Flat to 6/12	
062593	7RV-AF12	Adj Roof Flashing 6/12 to 12/12	
009764	7RV-RT	Vent Top	
009733	7RV-SC	Storm Collar	
009752	7RV-TC	Tee Cap	
009758	7RV-TF	Tall Cone Flat Roof Flashing	
009770	7RV-TS	Tee	

8" Gas Vent Round

Part #	Mfg #	Description	Price
009720	8RV-6	6" Round Pipe	
009715	8RV-12	12" Round Pipe	
009716	8RV-18	18" Round Pipe	
009717	8RV-2	24" Round Pipe	
009718	8RV-3	36" Round Pipe	
009719	8RV-5	60" Round Pipe	
009789	8RV-45	45° Adjustable Elbow	
009798	8RV-90	90° Adjustable Elbow	
009682	8RV-AJ	12" Adj Length Pipe	
009662	8RV-AF	Adj Roof Flashing Flat to 6/12	
088718	8RV-AF12	Adj Roof Flashing 6/12 - 12/12	
009667	8RV-DH	Draft Hood Connector	
009765	8RV-RT	Vent Top	
009734	8RV-SC	Storm Collar	
009753	8RV-TC	Tee Cap	
009759	8RV-TF	Tall Cone Flat Roof Flashing	
009771	8RV-TS	Tee	

Venting

Stainless Steel All Fuel Venting

Chimney Systems

- Rugged all fuel chimney
- Meets all UL® requirements
- Model SSII-Type HT tested to 2100°F
- Model SSII tested UL®-103 max temp of 1700°F
- Gravity venting only



Insulated Pipe

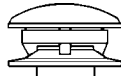

Round Top



Insulated Tee w/Cap



15° Insulated Elbow

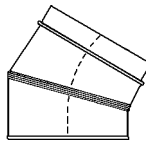

30° Insulated Elbow



Dripless Adptr w/Coupler



Wall Support Kit

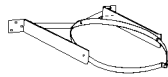

Wall Band

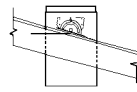

Roof Support

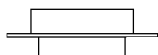

Ceiling Support

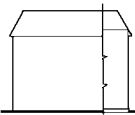

Attic Insulation Shield

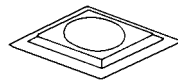

Fire Stop/Wall Spacer

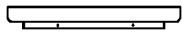

Finishing Collar

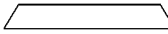

Storm Collar

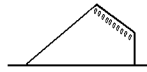

Adjustable Flashing

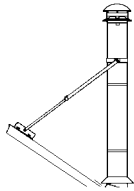

Roof Brace Kit



Locking Band

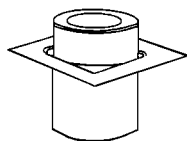

Joist Shield

SSII-Type HT 6" Insulated Pipe & Fittings

Part #	Mfg #	Description	Price
001049	6UT-9	6" x 9" Pipe	
001047	6UT-18	6" x 18" Pipe	
001048	6UT-36	6" x 36" Pipe	
001030	6T-AF6	0/12 - 6/12 Adj Flashing	
001029	6T-AF12	6/12 - 12/12 Adj Flashing	
001032	6T-CT	Round Top	
001033	6T-DSA	Dripless Smoke Pipe Adapter	
001034	6T-DSAC	Dripless Smoke Pipe Adapter w/Coupler	
070232	6T-EL15KIT	15° Elbow Kit	
001036	6T-FC	Finishing Collar	

Chimney Systems (Continued)

SSII-Type HT 6" Insulated Pipe & Fittings

Part #	Mfg #	Description	Price
001037	6T-FSP	Ceiling Support, Sq Plate	
001038	6T-IT	Tee	
021232	6T-JS	Joist Shield	
001039	6T-LB	Locking Band	
021355	6T-RBK	Roof Brace Kit	
001040	6T-RSP	Roof Support Package	
001041	5/6T-SC	6" Metal Storm Collar	
001043	6T-TF	0 - 2/12 Tall Cone Roof Flashing	
074623	6T-TPS	Fire Stop/Trim Collar w/Spacer	
001044	6T-WB	Wall Band	
001046	6T-WSK	Wall Support Kit	

SSII-Type HT 7" Insulated Pipe & Fittings

Part #	Mfg #	Description	Price
001059	7UT-18	7" x 18" Pipe	
001060	7UT-36	7" x 36" Pipe	
001050	7TAF-6	6/12 Flashing	
070237	7T-EL30KIT	30° Elbow Kit	
001051	7T-CT	Round Top	
001053	7T-FSP	Finish Support Pkg, Sq Plate	
001054	7T-IT	Tee	

SSII-Type HT 8" Insulated Pipe & Fittings

Part #	Mfg #	Description	Price
081186	8UT-6	8" x 6" Insulated Pipe	
001081	8UT-9	8" x 9" Insulated Pipe	
001079	8UT-18	8" x 18" Insulated Pipe	
080939	8UT-24	8" x 24" Insulated Pipe	
001080	8UT-36	8" x 36" Insulated Pipe	
001062	8T-AF6	Adj Flashing	
001065	8T-CT	Round Top	
001066	8T-DSAC	Dripless Smoke Pipe Adapter w/Coupler	
070234	8T-EL15KIT	15° Elbow Kit	
001069	8T-FSP	Ceiling Support, Sq Plate	
001070	8T-IT	Tee	
001071	8T-JS	Joist Shield	
001072	8T-LB	Locking Band	
001056	7/8T-SC	8" Metal Storm Collar	
001076	8T-WB	Wall Band	
001078	8T-WSK	Wall Support Kit	

Stainless Steel All Fuel Venting

SSII-Type HT 10" Insulated Pipe & Fittings

Part #	Mfg #	Description	Price
070246	10UT-36	10" x 36" Insulated Pipe	

SSII 10" Insulated Fittings

Part #	Mfg #	Description	Price
066181	10SAF-12	2/12 to 6/12 Roof Flashing	
012309	10S-CT	Round Chimney Top	
012314	10S-SC	Storm Collar	

Venting

WV Oval Venting

Gas Vent Oval Pipe & Fittings

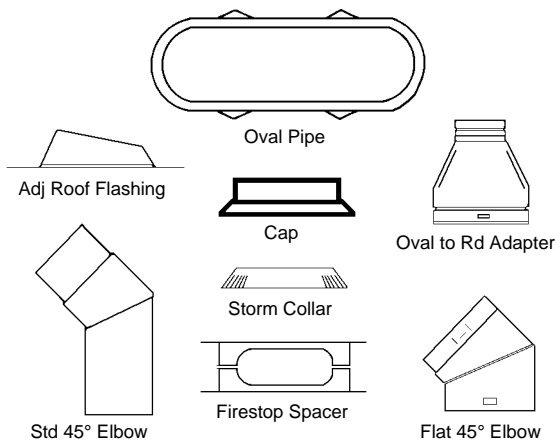

4" Gas Vent Oval

Part #	Mfg #	Description	Price
007919	4OV-12	12" Oval Pipe	
007920	4OV-2	24" Oval Pipe	
007921	4OV-3	36" Oval Pipe	
007922	4OV-4	48" Oval Pipe	
007923	4OV-5	60" Oval Pipe	
007924	4OV-45F	Flat 45° Elbow	
007925	4OV-45S	Standard 45° Elbow	
012142	4OV-4RV	Oval to 4" Round Adapter	
012133	4OV-AF	Adj Roof Flashing	
089500	4OV-FS	Firestop Spacer	
012145	4OV-SC	Storm Collar	
007918	4OV-TS	Oval to Round Tee	
007917	4OV-TC	Tee Cap	

5"/6" Gas Vent Oval

Part #	Mfg #	Description	Price
012135	5/6OV-12	12" Oval Pipe	
012136	5/6OV-2	24" Oval Pipe	
012137	5/6OV-3	36" Oval Pipe	
012138	5/6OV-4	48" Oval Pipe	
012139	5/6OV-5	60" Oval Pipe	
012150	5/6OV-45S	45° Oval Elbow - Standard	
012143	5/6OV-5RV	5" Oval to Round Adapter	
012144	5/6OV-6RV	6" Oval to Round Adapter	
012134	5/6OV-AF	Adj Roof Flashing	
012149	5/6OV-RT	Top	
012146	5/6OV-SC	Storm Collar	
012140	5/6OV-T5	Oval to 5" Round Tee	
012141	5/6OV-T6	Oval to 6" Round Tee	
012147	5/6OV-TC	Tee Cap	

Roof & Chimney Caps

Venting Caps

634/634M Black Roof Cap

- Built-in backdraft damper and bird screen
- 24 Gauge CRCQ Steel, black electrically-bonded finish



Part #	Mfg #	Description	Price
002548	634	Black Steel for 3-1/4" x 10" or 8" Round Duct	
074322	634M	Black Steel for 3-1/4" x 10" or 6" Round Duct	

636 Black Roof Cap

- Built-in backdraft damper and birdscreen
- 24 Gauge CRCQ Steel, black electrically-bonded finish



Part #	Mfg #	Description	Price
082892	636	Black Steel for 3" or 4" Round Duct	

639 Black Wall Cap

- Spring-loaded backdraft damper
- Built-in bird screen
- Steel baked black enamel finish
- 24 Gauge CRCQ Steel, black electrically-bonded finish



Part #	Mfg #	Description	Price
002550	639	Black Steel for 3-1/4" x 10" Duct	

641 Aluminum Wall Cap

- Built-in backdraft damper and birdscreen
- Aluminum natural finish



Part #	Mfg #	Description	Price
002551	641	Aluminum for 6" Round Duct	
024789	642	Aluminum for 3" or 4" Round Duct	

643 Aluminum Wall Cap

- Built-in backdraft damper
- Aluminum natural finish



Part #	Mfg #	Description	Price
081057	643	Aluminum for 8" Round Duct	

885-BL Black Wall Cap

- 4" to 3" Transition included
- Built-in bird screen
- 24 Gauge CRCQ Steel, black electrically bonded epoxy finish
- Built-in damper



Part #	Mfg #	Description	Price
145669	885BL	Black for 3" or 4" Round Duct	

Venting

Stainless Steel Venting

Venting

FasNSeal® Adapters

Weil McLain Tee Appliance Adapter



Part #	Mfg #	Size	Price
041443	300358	3"	

**FasNSeal® Single-Wall Special Gas Vent
Vent Length Pipe**

- Use to vent category II, III and IV appliances



Part #	Mfg #	Size	Price
040346	300001	3" x 6"	
040347	300015	3" x 12"	
040348	300045	3" x 18"	
040349	300060	3" x 24"	
040350	300075	3" x 36"	
041863	300002	4" x 6"	
041864	300016	4" x 12"	
041866	300061	4" x 24"	

Adjustable Vent Length Pipe

- Use to add length to straight length of FasNSeal® pipe
- Adds 2" - 14" of length
- Requires at least 2" overlap for a secure connection



Part #	Mfg #	Size	Price
046673	300250	3" x 18"	

45° Elbow

- Allows for better condensate management and less back pressure



Part #	Mfg #	Size	Price
041868	300131	4"	

90° Elbow

- Use to go from horizontal to vertical runs or vertical to horizontal runs
- Use to turn vent 90°



Part #	Mfg #	Size	Price
040352	300160	3"	
041869	300161	4"	

Bird Screen

- Use for 3" and 4" standard through-the-wall terminations



Part #	Mfg #	Size	Price
040356	300186	3"	
041873	300187	4"	

Horizontal Drip Tee

- Use to manage condensate in horizontal runs



Part #	Mfg #	Size	Price
040354	300236	3"	
041872	300237	4"	

Wall Thimble with Adjustable Vent Length Pipe

- Use for through-the-wall termination
- Fits between standard wall studs



Part #	Mfg #	Size	Price
040353	300280	3"	
041871	300281	4"	

Work Gloves

Work Gloves

Demolition Gloves

- Built-in terry cloth sweat wipe
- Velcro Closure for a secure fit
- Breathable Lining - Moisture wicking lining provides all day comfort
- Molded Knuckle Protection - TPR pad provides ultimate knuckle protection
- Palms and Finger Tips reinforced with Armortex® for ultimate durability and grip
- Smartwipe™ Knuckle - Permits the use of touch screen devices without removing gloves or wiping dirty finger tips across the screen



Part #	Mfg #	Description	Price
229541	48-22-8735	Small	
186454	48-22-8731	Medium	
186456	48-22-8732	Large	
186457	48-22-8733	Extra Large	
186458	48-22-8734	2X Large	

Fingerless Work Gloves

- Fingerless design for ultimate dexterity
- Reinforced and padded palm
- Built-in terry cloth sweat wipe
- Hook & loop closure for a secure fit
- Breathable lining provides all day comfort



Part #	Mfg #	Description	Price
224333	48-22-8745	Small	
224334	48-22-8741	Medium	
224335	48-22-8742	Large	
224336	48-22-8743	Extra Large	
224337	48-22-8744	2X Large	

Free-Flex Work Gloves

- Built-in terry cloth sweat wipe
- Free-Flex cuff for all day comfort
- Breathable lining provides all day comfort reinforced thumb seam
- Smartwipe™ Fingertips, Knuckles and Palms - Permits the use of touch screen devices without removing gloves
- High dexterity finger tips provide dexterity when handling small objects



Part #	Mfg #	Description	Price
224343	48-22-8715	Small	
224346	48-22-8711	Medium	
224347	48-22-8712	Large	
224348	48-22-8713	Extra Large	
224349	48-22-8714	2X Large	

Performance Work Gloves

- Built-in terry cloth sweat wipe
- Breathable lining provides all day comfort
- Hook & loop closure for a secure fit
- High dexterity finger tips provide dexterity when handling small objects
- Smartwipe™ Fingertips, Knuckles and Palms - Permits the use of touch screen devices without removing gloves



Part #	Mfg #	Description	Price
224338	48-22-8725	Small	
224339	48-22-8721	Medium	
224340	48-22-8722	Large	
224341	48-22-8723	Extra Large	
224342	48-22-8724	2X Large	

Gloves, Ear Plugs, Goggles, ETC

Gloves

Journeyman Utility Gloves (K1)

- *Supple, breathable, durable synthetic leather palm*
- *2-Way stretch spandex padded top features form-fitting elasticity*
- *Reinforced thumb, index finger and fingertips add protection*
- *Concealed interior seam stitching prevents snagging*
- *Wide opening elastic cuff*
- *Contact points on index finger and thumb feature smooth surface for improved handling of objects*

JOURNEYMAN™



Part #	Mfg #	Size	Price
106850	40052	Medium	
106851	40053	Large	
106852	40054	X-Large	

Journeyman™ Heavy-Duty Protection Gloves (K3)

- *Streamlined high-density accordion knuckle panel reduces impact*
- *High profile, impact absorbing molded Thermal Plastic Rubber (TPR) finger protection*
- *Non-slip rubberized Zeus™ Carino® finger and thumb grippers and panel on heel of hand provide grip control and longer wear*
- *Synthetic leather with breathable mesh side insert finger panels*
- *2-Ply synthetic leather palm with anatomically die cut Ethylene Vinyl Acetate (EVA) foam padded impact zones*
- *Thermal Plastic Rubber (TRP) cuff strap with hook and loop closure*
- *Neoprene cuff allows easier access with additional wrist protection and comfort*

JOURNEYMAN™



Part #	Mfg #	Size	Price
106857	40063	Large	

Work Wear

Gloves, Ear Plugs, Goggles, ETC

Gloves

Disposable Latex Glove

- *Extra large*
- *Reversible*



Part #	Mfg #	Type	Size	Price
060105	390-50177	Heavy-Duty	XL	

Work Wear

Gloves, Ear Plugs, Goggles, ETC

Gloves

Disposable Nitrile Glove

- Textured fingertips
- Powder-free
- 5 - 6 Mil
- 100/Box

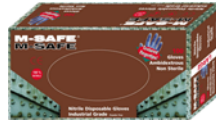

Part #	Mfg #	Description	Price
121772	3276L	Large	
133593	3276XL	Extra Large	

X10 Knucklehead Glove

- Synthetic leather palm
- Elastic wrist
- High visibility orange



Part #	Mfg #	Description	Price
148262	21242HOL	Large	
148263	21242HOXL	Extra Large	
148135	21242HOXXL	Extra Extra Large	

Split Cowhide Double Palm Glove

- Knuckle strap
- Wing thumb
- Polyethylene safety cuff



Part #	Mfg #	Description	Price
122046	4503CDPXL	Extra Large	

String Knit Cotton/Polyester Glove

- Ambidextrous
- PVC Dots on both sides
- Natural color



Part #	Mfg #	Description	Price
122623	3825L	Large	

A Grade Gold Deerskin Palm Glove

- Black stretch back
- Velcro closure
- Mechanics style
- Heatlok lined



Part #	Mfg #	Description	Price
129331	2150HM	Medium	
129332	2150HXL	Extra Large	
129346	2150HXXL	Extra Extra Large	

High Visibility Terry Lined Yellow Knit No Logo Glove

- Black rubber palm hides dirt
- Precurved design promotes easy flexing
- Rubber palm has excellent wear and resistance
- Super fit



Part #	Mfg #	Description	Price
144702	3396HYNL	Large	
144701	3396HYNXL	Extra Large	

High Visibility Yellow Knit Glove

- Summer version
- Black rubber palm hides dirt
- Precurved design promotes easy flexing
- Rubber palm has excellent wear and resistance
- Super fit



Part #	Mfg #	Description	Price
122621	3397HYL	Large	

High Visibility Yellow Knit No Logo Glove

- Rubber palm
- Excellent wear and resistance
- Super fit



Part #	Mfg #	Description	Price
140861	3397HYNM	Medium	
140863	3397HYNL	Large	
140858	3397HYNXL	Extra Large	

Work Wear

Gloves, Ear Plugs, Goggles, ETC

High Visibility Orange Knit Glove

- Summer version
- Black rubber palm hides dirt
- Precurved design promotes easy flexing
- Rubber palm has excellent wear and resistance
- Super fit



Part #	Mfg #	Description	Price
122620	3397HOL	Large	

High Visibility Orange Knit No Logo Glove

- Rubber palm
- Excellent wear and resistance
- Super fit

Part #	Mfg #	Description	Price
140860	3397HONM	Medium	
140862	3397HONL	Large	
140859	3397HONXL	Extra Large	

Work Wear

Gloves, Ear Plugs, Goggles, ETC

Gloves Gloves



Part #	Mfg #	Description	Price
030870	G50-204	Leather Palm Low Safety Cuff	

Disposable Latex Gloves

- 50 per box
- Powder free
- Large



Part #	Mfg #	Description	Price
224077	G50212	Blue Latex	

Vinyl Disposable Gloves

- 8 Pack
- Powder free
- Heavy-duty, multi-purpose
- One size fits all



Part #	Mfg #	Description	Price
190128	G50302	Blue Vinyl	

Blue Nitrile Gloves

- Powdered
- (50) Pair per box
- Thickness: 3 mil



Part #	Mfg #	Description	Price
227056	G50230	Blue Nitrile, LG/XL	
226327	G50231	Blue Nitrile, M/LG	

Disposable Respirators Dust Mask

- Disposable
- Non Toxic



Part #	Mfg #	Description	Price
175628	G30021	Box of Dust Masks	

Safety Hats

White Safety Hat

- Meets ANSI z89.1 requirements
- Short peak design creates greater upward visibility
- Comfortable 4-point suspension with terrycloth sweatbands



Part #	Mfg #	Description	Price
188732	H40002	Fits Sizes 6-1/2-8	
188735	H40004	Fits Sizes 6-1/2-8, Ratchet Suspension	

Gloves, Ear Plugs, Goggles, ETC

Cowhide Drivers Gloves

Elastic Back Rough Rider Gloves

- Made from top-grain leather
- Deep oil tanned
- Sewn with inset, keystone thumb
- Bound at cuff with leather
- Elastic back for an easy-on easy-off fit



Part #	Mfg #	Size	Qty	Price
051840	2500-L	Large	1 Pair	

Double Palm and Chore Cotton Gloves

Galeton Gold Cotton Chore Cotton Gloves

- 18 oz Quilted gold cotton chore
- Two layers of soft cotton
- Insulated against heat and cold
- Knit wrist



Part #	Mfg #	Size	Qty	Price
051838	3112-L	Large	1 Pair	

Side Split Leather Gloves

Premium Side Split Leather Palm Gloves

- Blue
- Side-split leather work gloves for longer wear and better protection
- Safety cuff



Part #	Mfg #	Size	Qty	Price
051839	2110-L	Large	1 Pair	

Latex and Vinyl Coated Gloves

Yellow Flock Lined Latex Cleaning Gloves

- 18 Mil natural latex
- Unsupported
- Soft flock lining absorbs moisture for easy off and on



Part #	Mfg #	Size	Qty	Price
051851	6000-L	Large	1 Pair	

Grain Leather Gloves

Rough Rider Grain Leather Palm Gloves

- Made from top-grain leather
- Deep oil tanned
- Lined with 100 grams 3M Thinsulate insulation
- Heavy yellow canvas
- Knit wrists



Part #	Mfg #	Size	Qty	Price
051841	2160-L	Large	1 Pair	

Hearing Protection

MAX Ear Plugs

- Preshaped foam
- NRR33 Rated



Part #	Mfg #	Description	Qty	Price
051843	9500	Uncorded	100/Pk	

Disposable Respirators

Nuisance Dust Mask

- Filters pollen, dust and other non-toxic particles from the air
- Withstands hot and humid conditions
- Double-shell construction resists collapse
- Easily adjustable nosepiece



Part #	Mfg #	Description	Qty	Price
051842	9700	Dust Mask	50/Box	

Jersey Gloves

Men's Brown Jersey Gloves



Part #	Mfg #	Size	Qty	Price
051837	1100-L	9 oz Large	1 Pair	

Work Wear

Work Gear

Work Wear

Hooded Jacket - Black

- GridIron™ Ripstop polyester
- FreeFlex™ Mobility
- Wind and water resistant
- 100g of High-loft insulation
- Fitted hood
- Rib knit cuffs and waist



Part #	Mfg #	Description	Price
224060	252B-S	Small	
224061	252B-M	Medium	
224062	252B-L	Large	
224063	252B-XL	Extra Large	
224065	252B-2X	2X Large	
224066	252B-3X	3X Large	

WorkSkin™ Cold Weather Base Layer - Gray

- Fast wicking sweat zones move moisture away from under arms and upper back
- Durable body fabric
- Drop tail extended back
- Seamless shoulders



Part #	Mfg #	Description	Price
224068	401G-S	Small	
224069	401G-M	Medium	
224070	401G-L	Large	
224071	401G-XL	Extra Large	
224072	401G-2X	2X Large	
224073	401G-3X	3X Large	

Work Wear

Heated Gear

Heated Jackets

All Kits Include

- (1) M12™ Heated Jacket
- (1) M12 REDLITHIUM™ 2.0 Compact Battery Pack (48-11-2420)
- (1) M12™ Lithium-ion Battery Charger (48-59-2401)
- (1) M12™ Battery Holder with 2.1A USB Charger

M12™ 3-in-1 Heated Jacket - Black

- Chest and back zones
- Up to 8 hours of run-time
- GridIron™ Ripstop polyester
- Low profile battery
- Washer and dryer safe
- FREEFLEX™ Mobility
- 3 Heat settings: High, Med, Low



Kits

Part #	Mfg #	Description	Price
224038	251B-21S	Small	
224039	251B-21M	Medium	
224041	251B-21L	Large	
224042	251B-21XL	Extra Large	
224043	251B-212X	2X Large	
224044	251B-213X	3X Large	

Jacket Only (Less Battery Pack)

Part #	Mfg #	Description	Price
224032	251B-20S	Small	
224033	251B-20M	Medium	
224034	251B-20L	Large	
224035	251B-20XL	Extra Large	
224036	251B-202X	2X Large	
224037	251B-203X	3X Large	

M12™ Heated Jacket - Black

- Chest and back zones
- Up to 8 hours of run-time
- TOUGHSHELL™ Stretch polyester
- Low profile battery
- Washer and dryer safe
- FREEFLEX™ Mobility
- 3 Heat settings: High, Med, Low



Kits

Part #	Mfg #	Description	Price
223832	201B-21S	Small	
223833	201B-21M	Medium	
223834	201B-21L	Large	
223835	201B-21XL	Extra Large	
223837	201B-212X	2X Large	
223838	201B-213X	3X Large	

Jacket Only (Less Battery Pack)

Part #	Mfg #	Description	Price
223817	201B-20S	Small	
223827	201B-20M	Medium	
223828	201B-20L	Large	
223829	201B-20XL	Extra Large	
223830	201B-202X	2X Large	
223831	201B-203X	3X Large	

M12™ Heated Jacket - Gray

- Chest and back zones
- Up to 8 hours of run-time
- TOUGHSHELL™ Stretch polyester
- Low profile battery
- Washer and dryer safe
- FREEFLEX™ Mobility
- 3 Heat settings: High, Med, Low



Kits

Part #	Mfg #	Description	Price
223852	201G-21S	Small	
223853	201G-21M	Medium	
223854	201G-21L	Large	
223855	201G-21XL	Extra Large	
223856	201G-212X	2X Large	
223857	201G-213X	3X Large	

Heated Gear

Jacket Only (Less Battery Pack)

Part #	Mfg #	Description	Price
223841	201G-20S	Small	
223842	201G-20M	Medium	
223848	201G-20L	Large	
223849	201G-20XL	Extra Large	
223850	201G-202X	2X Large	
223851	201G-203X	3X Large	

M12™ Heated Jacket - Red

- Chest and back zones
- Up to 8 hours of run-time
- TOUGHSHELL™ Stretch polyester
- Low profile battery
- Waster and dryer safe
- FREEFLEX™ Mobility
- 3 Heat settings: High, Med, Low



Kits

Part #	Mfg #	Description	Price
223865	201R-21S	Small	
223866	201R-21M	Medium	
223973	201R-21L	Large	
223974	201R-21XL	Extra Large	
223975	201R-212X	2X Large	
223976	201R-213X	3X Large	

Jacket Only (Less Battery Pack)

Part #	Mfg #	Description	Price
223858	201R-20S	Small	
223859	201R-20M	Medium	
223860	201R-20L	Large	
223861	201R-20XL	Extra Large	
223862	201R-202X	2X Large	
223864	201R-203X	3X Large	

M12™ Heated Jacket - Realtree Xtra® Camo

- Chest and back zones
- Up to 8 hours of run-time
- TOUGHSHELL™ Stretch polyester
- Low profile battery
- Waster and dryer safe
- FREEFLEX™ Mobility
- 3 Heat settings: High, Med, Low



Kits

Part #	Mfg #	Description	Price
223983	221C-21S	Small	
223984	221C-21M	Medium	
223985	221C-21L	Large	
223986	221C-21XL	Extra Large	
223988	221C-212X	2X Large	
223989	221C-213X	3X Large	

Jacket Only (Less Battery Pack)

Part #	Mfg #	Description	Price
223977	221C-20S	Small	
223978	221C-20M	Medium	
223979	221C-20L	Large	
223980	221C-20XL	Extra Large	
223981	221C-202X	2X Large	
223982	221C-203X	3X Large	

M12™ Women's Heated Jacket - Black

- Chest and back zones
- Up to 8 hours of run-time
- TOUGHSHELL™ Stretch polyester
- Low profile battery
- Waster and dryer safe
- FREEFLEX™ Mobility
- 3 Heat settings: High, Med, Low



Kits

Part #	Mfg #	Description	Price
223990	231B-21S	Small	
223992	231B-21M	Medium	
223993	231B-21L	Large	
223994	231B-21XL	Extra Large	

Heated Gear

Heated Jackets (Continued)

M12™ Women's Heated Jacket - Black Kits

Part #	Mfg #	Description	Price
223995	231B-212X	2X Large	

Heated Hoodies

All kits include

- (1) M12™ Heated Hoodie
- (1) M12™ REDLITHIUM™ Battery (48-11-2401)
- (1) M12™ Lithium-ion Battery Charger (48-59-2401)
- (1) M12™ Battery Holder

M12™ Heated Hoodie - Black

- Chest and back zones
- Up to 6 hours of run-time
- Waffle weave lining traps heat
- Waster and dryer safe
- Durable utility pockets
- 3 Heat settings: High, Med, Low



Kits

Part #	Mfg #	Description	Price
224014	301B-21S	Small	
224015	301B-21M	Medium	
224016	301B-21L	Large	
224017	301B-21XL	Extra Large	
224018	301B-212X	2X Large	
224019	301B-213X	3X Large	

Hoodie Only (Less Battery Pack)

Part #	Mfg #	Description	Price
224008	301B-20S	Small	
224009	301B-20M	Medium	
224010	301B-20L	Large	
224011	301B-20XL	Extra Large	
224012	301B-202X	2X Large	
227263	301B-203X	3X Large	

M12™ Heated Hoodie - Gray

- Chest and back zones
- Up to 6 hours of run-time
- Waffle weave lining traps heat
- Waster and dryer safe
- Durable utility pockets
- 3 Heat settings: High, Med, Low



Kits

Part #	Mfg #	Description	Price
224002	301G-21S	Small	
224003	301G-21M	Medium	
224004	301G-21L	Large	
224005	301G-21XL	Extra Large	
224006	301G-212X	2X Large	
224007	301G-213X	3X Large	

Hoodie Only (Less Battery Pack)

Part #	Mfg #	Description	Price
223996	301G-20S	Small	
223997	301G-20M	Medium	
223998	301G-20L	Large	
223999	301G-20XL	Extra Large	
224000	301G-202X	2X Large	
224001	301G-203X	3X Large	

M12™ Heated Hoodie - Red

- Chest and back zones
- Up to 6 hours of run-time
- Waffle weave lining traps heat
- Waster and dryer safe
- Durable utility pockets
- 3 Heat settings: High, Med, Low



Kits

Part #	Mfg #	Description	Price
224026	301R-21S	Small	
224027	301R-21M	Medium	
224028	301R-21L	Large	
224029	301R-21XL	Extra Large	
224030	301R-212X	2X Large	
224031	301R-213X	3X Large	

Hoodie Only (Less Battery Pack)

Part #	Mfg #	Description	Price
224022	301R-20L	Small	
224021	301R-20M	Medium	

Work Wear

Heated Gear

Heated Hoodies (Continued)

M12™ Heated Hoodie - Red Hoodie Only (Less Battery Pack)

Part #	Mfg #	Description	Price
224020	301R-20S	Large	
224023	301R-20XL	Extra Large	
224024	301R-202X	2X Large	
224025	301R-203X	3X Large	

M12™ Heated Vest - Black

- Up to 6 hours of run-time
- GridIron™ Ripstop polyester
- Thermal fleece lining
- 3 Heat settings: High, Med, Low



Kits

- (1) M12™ Heated Vest - Black (Vest Only) (271B-20)
- (1) M12™ REDLITHIUM™ Battery (48-11-2401)
- (1) M12™ Battery Holder

Part #	Mfg #	Description	Price
224054	271B-21S	Small	
224055	271B-21M	Medium	
224056	271B-21L	Large	
224057	271B-21XL	Extra Large	
224058	271B-212X	2X Large	
224059	271B-213X	3X Large	

Vest Only (Less Battery Pack)

Part #	Mfg #	Description	Price
224045	271B-20S	Small	
224046	271B-20M	Medium	
224049	271B-20L	Large	
224050	271B-20XL	Extra Large	
224051	271B-202X	2X Large	
224053	271B-203X	3X Large	

Heated Hand Warmers

Kits Include

- (1) M12™ Cordless heated hand warmer only
- (1) M12™ REDLITHIUM™ battery (48-11-2401)
- (1) M12™ Lithium-ion battery charger (48-59-2401)
- (1) M12™ Battery holder

M12™ Cordless Black Heated Hand Warmer



Part #	Mfg #	Description	Price
160200	2322-21	Black Hand Warmer Kit	
160199	2322-20	Black Hand Warmer Only	

M12™ Cordless Realtree Xtra® Camo Heated Hand Warmer



Part #	Mfg #	Description	Price
160198	2321-21	Camo Hand Warmer Kit	
160197	2321-20	Camo Hand Warmer Only	

Safety Glasses

Safety Glasses
Dakura Safety Glasses



Part #	Mfg #	Description	Price
160443	TSM21-G15-7	Safety Glasses Polarized Silver	
160444	TSM216	Safety Glasses Black Smoke Polarized	

Kazbek Safety Glasses



Part #	Mfg #	Description	Price
160442	TSKXL-111	Safety Glasses Black Clear	
160441	TSKAP218	Safety Glasses Polarized Blue	

Zorge Saftey Glasses



Part #	Mfg #	Description	Price
160436	DZ111	Saftey Glasses Clear	
160437	DZ111-2.0	Saftey Glasses Magnifier Clear	
160438	DZ112	Saftey Glasses Yellow	
160439	DZ116	Saftey Glasses Smoke	

Wolf Peak Safety Glasses



Part #	Mfg #	Description	Price
160445	TSRAP	Reclus Polarized Black/Aqua Precision Blue	

Work Wear

Safety Glasses

Nemesis® Safety Glasses

- Single lens wrap-around



Part #	Mfg #	Description	Price
146053	G30-011	Clear	
105548	G30-012	Smoke Mirror	
128696	G30-014	Camo/Bronze	

Hellraiser Safety Glasses



Part #	Mfg #	Description	Price
135022	G30-015	Clear	
135023	G30-016	Smoke	

Safety Glasses

Safety Glasses

Sportster Safety Glasses

- Curved, wrap-around lenses
- Super-light
- 99% UV-A & UV-B Protection



Part #	Mfg #	Description	Qty	Price
080260	9200042	Indoor/Outdoor	1 Pair	

Work Wear

Shoe Covers

Shoe Covers

Waterproof Shoe Cover

- Skid-proof soles
- Waterproof
- Multiuse or disposable
- Dispenser box
- Designed to fit over a size 18 work boot
- Dark blue



Part #	Mfg #	Description	Price
138851	20361	Waterproof Shoe Covers, Box of 50	

Shoe Covers

Shoe Covers
Shoe Liner Booty



Part #	Mfg #	Description	Price
145266	SC-1	Bx/50 Pair Shoe Liner Bootie	

Work Wear



Shoe Covers

Shoe Covers

Disposable Shoe Cover

- Job pack
- Blue-spun polypropylene - non-waterproof



Part #	Mfg #	Size	Price
035439	390-50175	5-15	

Work Wear

Shoe Covers

Yaktrax® Ice Traction Devices

Yaktrax® Icewalker

- Ultra lightweight ice traction
- Easy on/off
- Spikeless patented skid lock coil system
- Abrasion resistant 1.2mm steel coil
- Rust-resistant and crush-resistant
- 100% Satisfaction guaranteed



Part #	Mfg #	Size	Color	Fits Shoe Size:	Price
130634	08601	Small	Black	Men's 5 to 8-1/2, Women's 6-1/2 to 10	
128220	08603	Medium	Black	Men's 9 to 11, Women's 10-1/2 to 12-1/2	
128219	08605	Large/Extra-Large	Black	Men's 11-1/2 to 13-1/2, Women's 13 to 15	

Work Wear



Shoe Covers

Page Left Blank

Work Wear



Product Index

A

A-Coils	
Hydron Module.....	209
Rheem.....	30
A/C Disconnects DiversiTech.....	351
A/C Whips DiversiWhips.....	105
Access Tees Ruud Threaded.....	724
Acid Neutralizers Nu-Calgon.....	80
Acid Test Kits Nu-Calgon.....	726
Actuators	
Honeywell Damper.....	423
Uponor.....	268
Watts Radiant Manifold Valve.....	271
Adapters Chicago Faucets.....	456
Additives Rhomar Boiler.....	280
Adhesive Fasteners Duro Dyne.....	433
Adhesives	
Hardcast Duct Liner.....	141, 424
RCD Corp Mastic.....	143
Vapco Mean Green Duct.....	82
Adhesives & Sealants Ruud.....	82
Advanced Industrial Components Heat Exchangers.....	304
Agri Drain Tape.....	354
Air Boosters Duralast Products.....	133
Air Cleaner Media	
GeneralAire.....	25
Glasfloss Z-Line.....	19
Air Cleaners	
GeneralAire.....	25
Honeywell Media.....	24
Lifebreath.....	8
Air Conditioners	
LG Electronics PTAC.....	65
Nordyne.....	44-45
Ruud Package Gas/Electric.....	68
Air Conditioning Systems Fujitsu.....	75
Air Connectors Hart & Cooley.....	144
Air Diffusers	
Airtec.....	217, 228
Lifebreath.....	219
RectorSeal.....	217, 228
Air Eliminators	
Amtrol.....	272
Bell & Gossett.....	273
Honeywell.....	274
SpiroTherm.....	277
Air Filter Replacement Media.....	23
Air Filters Honeywell Media.....	24
Air Handler Blocks DiversiTech.....	94
Air Handler Units Single Zone.....	49
Air Handlers	26
Air Handlers Hydron Module.....	208
Air Intake Vent Deflect-O.....	216
Air Purgers Amtrol.....	272
Air Purification Systems UltraVation.....	5
Air Purifiers Sanuvox.....	6
Air Releases SpiroTherm.....	277
Air Sensors Robertshaw Switches.....	332
Air Valves	
Hoffman Specialty Radiator Steam.....	275
Jones Stephens.....	276
Air Ventilators Honeywell.....	423
Air Vents Bell & Gossett.....	273
Airtec	
Air Diffusers.....	217, 228
Flanges.....	217
Alkaline Battery Pack Protech.....	641
Aluminum Flex Duct.....	803
Aluminum Pipe Round.....	803
Aluminum Wrenches Ridgid.....	789
Amazing Tape Agri Drain.....	354
Amtrol	
Air Eliminators.....	272
Air Purgers.....	272
Tanks.....	320-321
Anti-Freeze Hercules.....	283
Anti-Vibration Pads	553
Anti-Vibration Pads	
Bramec.....	418
Mason Industries.....	93
Antifreeze Harvey.....	279
Apollo	
Water Gauge Components.....	322
Water Gauges.....	322
Aquastats	
Honeywell.....	284
Honeywell Controllers.....	286
Honeywell Relays.....	285
Aquatrol Honeywell Boiler Controls.....	289
Arbors Milwaukee.....	613
Aspen Mfg	
Coils.....	37
Evaporator Coils.....	35-36
Pistons.....	37
TXV Valves.....	37
Atco	
Flex Duct.....	146-147
Insulated Sleeves.....	148



Product Index

Atco - Masterfit Collars	176
Auger Bits Lenox Ship Auger.....	574
Augers	
General Wire Spring Co Closet.....	602
General Wire Spring Co Flexicore Wire Rope Center.....	689
General Wire Spring Co Urinal.....	602
Aviation Snips	
Klein Tools.....	779
Lenox.....	780
Awls Malco.....	773

B

B&D Mfg Inc	
Flow Center Accessories.....	214
Flow Centers.....	214
Grundfos Pumps.....	213
Parts.....	215
B-Vent Selkirk Gas Vent.....	819-820
B-Vent Oval Pipe & Fittings Selkirk	
Metalbestos.....	824
Ball Valves	
Refrigerant.....	126
Webstone.....	305, 316
Ballcocks Kohler.....	489
Band Saw Blades	
Lenox.....	740
Milwaukee.....	747
Band Saws Milwaukee.....	717
Bangers Duro Dyne.....	433
Barbed Fittings B&D Mfg Inc Brass.....	215
Barometric Make-Up Air Controls	
Skuttle.....	815
Basco Tub & Shower Accessories.....	451
Baseboard Fittings Weil-McLain.....	287
Baseboard Heaters Weil-McLain.....	287
Basin Wrenches	
Pasco.....	797
Ridgid.....	790
Basins Sump & Sewage.....	448
Basset	
Brackets.....	142
Strap.....	142
Bath Fans Panasonic.....	809, 811
Bath Installation Aids Delta.....	460
Bath Waste Parts Delta.....	469
Batteries	
Protech.....	641
Rayovac Flashlight.....	595
Bearings Bell & Gossett.....	452

BearTrap Steam Traps Hoffman Specialty.....	317
Bell & Gossett	
Air Eliminators.....	273
Air Vents.....	273
Check-Trol Isolation Flanges.....	452
Dual Unit Valves.....	312
Parts & Accessories.....	453
Pressure Reducing Valves.....	312
Pump Motors & Accessories.....	452
Belts Fenner Drives.....	478
Benders Rigid.....	589, 658
Big Nipper Bramec Tubing Cutter.....	665
Bit Sets	
Milwaukee.....	577, 580-581, 760-761
Milwaukee Boring.....	581
Bits	
Klein Tools Drill.....	768
Lenox Drill Vari-Bit.....	574
Lenox Ship Auger.....	574
Lenox Wood.....	574
Malco Drill.....	576
Malco Power.....	755
Shoemaker.....	225
Blade & Wheel Pullers Sensible Products.....	802
Blade Sets Milwaukee.....	746
Blades	
Lenox Band Saw.....	740
Lenox Handsaw.....	737
Lenox Saw.....	737
Malco Saw.....	752
Milwaukee.....	742
Ridgid Abrasive Saw.....	741
Ridgid Tubing Cutter.....	664
Utility Knife.....	630
Blower Assemblies Ruud.....	538
Blower Parts Ruud.....	553
Blower Wheels	
Nordyne.....	567
Ruud Heating & AC.....	533
Blowers	
Rheem Draft Inducer.....	538
Ruud Water Heater.....	513
Boiler Gas Wall-Mount Weil-McLain.....	260
Boiler Brushes Mill-Rose.....	643
Boiler Chemicals	
Gunk.....	281
Silver King Mfg.....	282
Boiler Controls	
Honeywell Aquatrol.....	289
Hydrolevel.....	309



Product Index

Boiler Drain Valves Watts Regulator.....	295
Boiler Drains Nibco.....	294
Boiler Parts Sentinel Weil-McLain.....	566
Boiler Parts & Components Weil-McLain.....	562
Boiler Treatments Rhomar.....	280
Boiler Valves Watts Pressure Regulators..	278, 310, 313
Boiler/DHW Controls Tekmar.....	292
Boilers	
Rinnai.....	254
Thermolec.....	255
Thermolec Electric Modulating.....	255
Triangle Tube.....	256
Triangle Tube Condensing.....	256
Weil-McLain Gas.....	258
Booster Fans Duralast Air.....	133
Boot Hangers Speedi-Boot.....	171
Boring Bit Sets Milwaukee.....	581
Box Wrenches Klein Tools.....	794
Brackets	
A/C.....	95
Air Conditioner.....	96
Basset.....	142
DiversiTech A/C Mounting.....	94
DiversiTech Motor.....	558
ThermO Mfg Mounting.....	123
Bradley Corp Washfountain Parts.....	454
Bramec	
Condensate Traps.....	347
Electrical Boxes.....	349
Electrical Switches.....	349
Equipment Pads.....	418
Equipment Stands.....	96
Furnace Mounting Blocks.....	96
HVAC Supplies.....	96, 418
Insulation Tape.....	429
Light Bulbs.....	785
Smoke Testers.....	373
Thermostats.....	379
Tubing Cutters.....	665
Wall Vents.....	808
Wire Connectors.....	416
Brass Fittings B&D Mfg Inc.....	215
Brass Manifolds Uponor.....	262-263
Brizo	464
Broan Venting Caps.....	825
Brushes	
Fin Whisks.....	638
Mill-Rose Boiler/Flue.....	643
Mill-Rose Cleaning.....	643
Bucket Organizers Stuff Sorter.....	655
Buckets Jones Stephens.....	650

Bulbs	
Bramec Light.....	785
Sanuvox UV Replacement.....	6
Bully Tools	
Shovels.....	784
Spades.....	784
Burner Controls	
Honeywell.....	413
Honeywell Gas.....	355-356
Honeywell Oil.....	365
Burners	
Honeywell Pilot.....	369
Nordyne.....	567
Ruud.....	553
Ruud Heating & AC.....	553
By-Pass Valves Uponor.....	266

C

C & S Mfg	
Basset Brackets.....	142
Basset Strap.....	142
Duct Hangers.....	142
Pipe Hangers.....	142
C02 Cartridges Swoosh.....	88
Cable	
General Wire Spring Co Flexicore.....	688
General Wire Spring Co Replacement ..	688
Honeywell.....	407
Cable Connectors General Wire Spring Co.....	688
Cable Cutters General Wire Spring Co.....	688
Cable Saws Mill-Rose PVC.....	753
Capacitors	
DiversiTech.....	333
Franklin Electric.....	479
Nordyne.....	567
Ruud.....	338, 340
Ruud Start.....	339
Caps	
Broan Venting.....	825
Ruud Sealing.....	79
Sheet Metal.....	167, 192
Spiral Duct.....	197
Carrying Cases Milwaukee.....	652
Cartridges	
Chicago Faucets.....	455
Moen Faucet.....	502
Spectroline.....	121
Cases Milwaukee.....	652
Cast Brass Fittings Dearborn Brass.....	458



Product Index

Caulk Guns Jones Stephens.....	648
Caulking Guns Harvey.....	642
Caulking Tools Jones Stephens.....	648
Caution Tape Jones Stephens.....	649
Ceiling Support Flanges RectorSeal.....	217
Cement Parker Hannifin Furnace.....	342
Charging Hoses Robinair.....	727
Chatham Brass Silicone Sealants.....	817
Check Valves Taco Inc Flo-Check.....	302
Chemicals	
Drain Cleaning.....	603
Ruud.....	3, 82-83, 86, 645, 725
Silver King Mfg Boiler.....	282
Cherne Clog Buster.....	601
Chicago Faucets	
Cartridges.....	455
Gooseneck Spouts.....	456
Handles.....	455
Outlets & Adapters.....	456
Parts.....	457
Pre-Rinse Faucet Parts.....	455
Pre-Rinse Hose.....	455
Renewing Kits.....	457
Shanks.....	457
Single Water Inlet Faucets.....	455
Spouts.....	456
Chimney Liner Kits Metalbest.....	805
Chimney Systems Selkirk.....	822
Chimney Vent Selkirk.....	824
Choke Ruud.....	553
Circuit Protection Ruud.....	615
Circular Saw Blades Milwaukee.....	747
Circular Saws Milwaukee.....	716
Circulator Pumps Grundfos.....	296, 298, 300
Clamp Meters Klein Tools.....	623
Clamp-On Meters MA-Line.....	622
Classic Manifold Extension Kit	
TruFLOW.....	262
Cleaners	
Hand.....	439
Klein Tools Hand.....	438
Silver King Mfg Boiler.....	282
TR Industries.....	441
Cleaning Brushes Mill-Rose.....	643
Clog Buster Drain Flushers.....	601
CO Detectors UEI.....	620
Coil Cleaners	
Nu-Calgon.....	80
Ruud.....	82-83
Coil-Tack Hardcast.....	141
Coils	

Aspen Mfg.....	37
Nordyne.....	38-39
Ruud Evaporator.....	31
Collars	
Atco - Masterfit.....	176
Galv Sheet Meal.....	179
Combo Tool Kits Milwaukee.....	712
Comfort-Aire	
PTAC Accessories.....	67
PTACs.....	67
Communicating Thermostats	
Honeywell.....	420
Compression Fittings Watts Radiant	
PEX.....	271
Compressors Ruud Heating & AC.....	533
Concentric Venting DiversiTech.....	230
Concrete Products TVM.....	436
Condensate Drain Cleaners DiversiTech.....	88
Condensate Drain Pans DiversiTech.....	92
Condensate Overflow Switches	
DiversiTech.....	89
Condensate Overflows Ruud.....	91
Condensate Pumps	
DiversiTech.....	345
EZ Trap.....	346
Liberty Pumps.....	344
Little Giant.....	343
Condensate Traps	
Bramec.....	347
EZ Trap.....	90
Sioux Chief.....	348
Condenser Fin Tools Whisk Brushes.....	638
Condenser Motors Ruud.....	542
Condenser Pads	
Bramec.....	418
DiversiTech.....	94
Condensing Boilers Triangle Tube.....	256
Condensing Unit	
Achiever Plus Series.....	42
Achiever Series.....	40
Ultra Series.....	42
Condensing Units	
Nordyne.....	44-45
Single Zone.....	49
Conduit LiquidTite.....	105
Conduit Cutters Ridgid.....	657
Connector Systems Ductmate.....	138
Connectors	
Bramec Wire.....	416
Duro Dyne Flexible Duct.....	131
Contactors	
Honeywell.....	102



Product Index

Nordyne.....	567
Ruud.....	103
Control Boards Nordyne.....	567
Control Flanges Bell & Gossett Check-Trol.....	452
Control Module	548
Control Modules Nordyne.....	567
Controls	
Hydrolevel Boiler.....	309
Lifebreath.....	9
Limit.....	508
Ranco Commercial Refrigeration.....	99
Ranco Commercial Temperature.....	99
Ruud.....	101, 106
Ruud Water Heater.....	513
Tekmar.....	292
Tekmar Heating.....	292
White-Rodgers Hydronic.....	328
Cooling Tower Treatments Nu-Calgon..	87
Copeland Scroll Compressors.....	534
Copper Tubing, Cutter.....	660
Copper Manifolds Uponor.....	262
Copper Tubing Cutters General Wire Spring Co Autocut.....	661
Cordless Tools.....	706
Cordless Accessories Milwaukee.....	719
Cordless Batteries Milwaukee.....	719
Cordless Drills Milwaukee.....	699
Cordless Saws Milwaukee.....	704
Cordless Tools ,.....	706
Cordless Tools	706
Cordless Tools Milwaukee.....	591, 690, 695, 698, 704
Corners Ductmate.....	138
Couplers Spiralink.....	319
Cover Plates Honeywell Thermostat.....	399
CPS Products Vacuum Gauges.....	724
Crankcase Heaters Ruud.....	106, 108
Crimpers	
Klein Tools.....	778
Malco.....	774-775
Cut-Off Machine Accessories Milwaukee.....	721
Cut-Off Machines Milwaukee.....	717
Cut-Offs Hydrolevel Low Water.....	309
Cutter Blades Ridgid.....	664
Cutter Parts	
Ridgid Pipe.....	671
Ridgid Tubing.....	658
Cutter Wheels	
Milwaukee.....	696
Ridgid Pipe.....	671

Ridgid Tubing.....	658, 664
Cutters	
Bramec Tubing.....	665
General Wire Spring Co Cable.....	688
Klein Tools PVC.....	666
Klein Tools Wire Strippers/Cutters.....	684
Lenox Tubing.....	659, 669
Malco Flex Duct.....	775
Malco Hole.....	500, 774
Ridgid Pipe.....	670-671
Ridgid Tubing.....	657, 664
Tube and Pipe.....	668
Uponor PEX Tube.....	267
Cutting & Notching Tools Klein Tools....	779

D

Damper Accessories Hardcast.....	141
Damper Actuators Honeywell.....	423
Dampers	
Galv Sheet Metal.....	192
Honeywell.....	421
Lifebreath.....	10
Sheet Metal.....	190
Shoemaker.....	218, 221
Weil-McLain.....	563
Dearborn Brass	
Cast Brass Fittings.....	458
Waste Repair Parts.....	458
Deburring Tools Ridgid.....	675
Deflect-O	
Dryer Vent.....	216
Specialty Vents.....	216
Defrost Boards Nordyne.....	567
Defrost Controls	
Paragon Electric.....	98
Ruud.....	101
Dehumidifiers Honeywell.....	17
Dehumidistats	
Remote.....	10
Residential.....	10
Delavan Oil Burner Nozzles.....	367
Delta	
Bath Waste Parts.....	469
Kitchen Sprays.....	464
Parts.....	470-472
Plumber's Box of Parts.....	471
Shower Parts.....	468
Single Handle Repair Kits.....	459
Soap/Lotion Dispenser Accessories.....	466



Product Index

Tools.....	459
Detectors UEI Carbon Monoxide.....	620
Die Heads Ridgid.....	676
Dielectric Unions Watts Regulator.....	561
Dies Ridgid Pipe.....	676
Diffusers	
DiversiTech.....	222
Shoemaker.....	218, 220, 224, 227
Digital Electronic Timers Lifebreath.....	8
Dirt Separators SpiroTherm.....	277
Disconnects DiversiTech.....	351
DiversiTech	
Air Handler Blocks.....	94
Capacitors.....	333
Concentric Venting.....	230
Condensate Drain Cleaners.....	88
Condensate Drain Pans.....	92
Condensate Float Switches.....	89
Condensate Pumps.....	345
Disconnects.....	351
E-Lite Plastic Condenser Pads.....	94
Fuses.....	351
Diversitech Gas Unit Heater Accessories..	124
DiversiTech	
LiquidTite Flex Conduit & Fittings.....	105
Lubricants.....	444
Mini-Split Drain Lines.....	122
Motor Brackets.....	558
Motors.....	558
Mounting Brackets.....	94
Refrigerant Recovery.....	84
SpeediChannel Line Set Covers.....	122
Tape.....	352
Tools.....	640
Utility Strap.....	638
Ventilation Products.....	222, 804
DiversiWhips A/C Whips.....	105
Diversifiers Galv Sheet Metal.....	806
Dividers Malco.....	773
Door Switches	
Nordyne.....	567
Ruud Heating & AC.....	552
Downflow Gas Furnace	232
Draft Inducers Tjernlund.....	818
Drain Cleaners	
Clog Buster.....	601
DiversiTech Condensate.....	88
Ken-Way.....	687
Drain Cleaning General Wire Spring Co...	688-689
Drain Cleaning Chemicals Harvey.....	603
Drain Cleaning Tools Harvey.....	603

Drain Flushers Richard Specialty.....	600
Drain Lines DiversiTech.....	122
Drain Pans	
DiversiTech.....	92
Ruud.....	34
Ruud Heating & AC.....	552
Drain Tees	79
Drain Valves Watts Regulator Boiler Drain	295
Drains	
Delta Lavatory.....	459
T&S Brass Sink Waste Valve.....	528
Drawbands Sheet Metal.....	190, 192
Drill Accessories Milwaukee.....	581, 614
Drill Bits	
Jones Stephens.....	770
Klein Tools.....	768
Lenox Ship Auger.....	574
Lenox Vari-Bit.....	574
Lenox Wood.....	574
Malco.....	576, 755
Milwaukee.....	582, 584, 613
Pasco.....	586
Straight Shank.....	586
Drill Kits Milwaukee.....	715
Drills	
Malco Turboshear.....	773
Milwaukee.....	714-716
Drivers Gloves Galeton.....	833
Drybox Mill-Rose.....	643
Dryer Vent Deflect-O.....	216
Dryer Vents Jones Stephens.....	807
Dual Unit Valves Bell & Gossett.....	312
Duct	
Atco Flex.....	146-147
Atco Insulated Sleeves.....	148
Flex Aluminum.....	803
Galv Sheet Metal.....	160, 162, 165, 169
Duct Adhesives Vapco Mean Green.....	82
Duct Boosters Tjernlund.....	132
Duct Connectors Flexible.....	131
Duct Cutters Malco Flex.....	775
Duct Fans Tjernlund.....	132
Duct Fittings	
Galv Sheet Metal.....	160, 162, 165, 169
General Plastics.....	157-158
Duct Hangers C & S Mfg.....	142
Duct Liner	425
Duct Liner Adhesives Hardcast.....	141, 424
Duct Sealants	
Hardcast.....	140-141, 426



Product Index

RCD Corp Mastics.....	143
Duct Strap Basset.....	142
Duct Stretchers Malco.....	773
Duct Tape Polyken Technologies.....	134
Duct Tools Malco Flex Fiberglass.....	775
Duct Wrap Foil.....	427
Ductless Split Systems Fujitsu.....	75
Ductmate	
Connector Systems.....	138
Corners.....	138
Duralast Products Air Boosters.....	133
DuraVent	
FasNSeal Adapters.....	826
FasNSeal Gas Vent.....	826
Duro Dyne	
Adhesive Fasteners.....	433
Flexible Duct Connectors.....	131
Insulation Fasteners.....	139, 433
Dust Masks Jones Stephens.....	832
Dye Capsules Spectroline.....	121
Dynamic Air Cleaner Media.....	21
DynaStick Duro Dyne.....	433

E

Eave Vent Deflect-O.....	216
ecobee Thermostats.....	384
Economizers Ruud.....	73
EcoVent Fans Panasonic.....	812
EL Mustee Shower Stall Parts.....	506
Electric Heat Kits Ruud.....	29
Electric Modulating Boilers Thermolec..	255
Electrical Boxes	
Bramec.....	349
Handy Box.....	349
Electrical Components Energy Saving	
Products.....	482
Electrical Disconnects DiversiTech.....	351
Electrical Receptacles Duplex.....	349
Electrical Switches Bramec.....	349
Electrical Tape Scotch 3M Super 33+.....	352
Electrical Test Leads Ruud.....	619
Electrical Testers	
Klein Tools.....	623
UEI.....	621
Electronic Tools	729
Element Wrenches Ruud Water Heater...	514
Elkay	
Drinking Fountain & Water Cooler Parts	476
EZH2O Parts.....	476

Replacement Filters.....	476
Sink Parts & Accessories.....	475
Empire	
Direct Vent Fireplaces.....	231
Parts.....	477
End Caps Sheet Metal.....	190
Energy Saving Products Electrical	
Components.....	482
Equipment Brackets Bramec.....	96
Equipment Pads	
Bramec.....	418
DiversiTech.....	94
Equipment Stands Bramec.....	96
ERVs Honeywell.....	423
Escutcheon's Uponor PEX Tubing.....	266
Evaporator Coils	
Aspen Mfg.....	35-37
Nordyne.....	38-39
Rheem.....	30
Ruud.....	31
Evaporator Pads	480
Evaporator Pads Honeywell.....	13
Exhaust Fans Parts & Accessories.....	812
Expansion Tanks Amtrol.....	320-321
Expansion Valves Ruud Heating & AC.....	534
Extension Cords Jones Stephens.....	788
Extrol Expansion Tanks.....	320
EZ Trap	
Condensate Pumps.....	346
Condensate Traps.....	90
EZH2O Parts Elkay.....	476

F

Fan Blade Pullers Sensible Products.....	802
Fan Blades	
Nordyne.....	567
Ruud Heating & AC.....	535
Fan Centers	
Honeywell.....	484
Ruud.....	535
Fan Controls Honeywell.....	364
Fans	
Fantech Radon Mitigation.....	447
Lifebreath Inline.....	814
Panasonic Ventilating.....	809, 811
Fantech Radon Mitigation Fans.....	447
FasNSeal Adapters DuraVent.....	826
FasNSeal Gas Vent DuraVent.....	826
Fasteners	



Product Index

Duro Dyne Insulation.....	139, 433
Hardcast Insulation.....	434
Faucet Cartridges Moen.....	502
Faucet Handles	
Chicago Faucets.....	455
T&S Brass.....	528
Faucet Parts	
Gerber.....	481
T&S Brass.....	528
Tapco.....	450
Faucet Repair Kits T&S Brass.....	528
Faucet Repair Parts Union Brass.....	532
Faucet Spouts	
Chicago Faucets.....	456
T&S Brass.....	528
Faucet Valves Kohler.....	489
Faucets	
Chicago Faucets.....	455
Kohler Valve Repair & Accessories.....	489
Fenner Drives V-Belts.....	478
Fiberglass Insulation	428
Files Milwaukee.....	614
Fill-Trol Valves Amtrol.....	321
Filter Cores	
Ruud.....	551
Ruud Heating & AC.....	551
Filter Driers Ruud.....	110
Filter Kits Ruud.....	557
Filter Media Ruud.....	4, 22
Filter Racks Sheet Metal.....	169
Filter-Driers	
Parker Hannifin.....	112
Ruud.....	109-110, 113
Filters	
General Filters Fuel.....	368
Glasfloss.....	20, 210
Glasfloss Z-Line Media.....	19
Glasfloss Z-Line Pleated.....	19
Honeywell Media.....	24
Hydron Module.....	211
Fin Tool Kits Ruud.....	639
Fin Tools Whisks.....	638
Fire Sprinklers Uponor.....	204
Fireplaces Empire Direct Vent.....	231
Fitting Assemblies Uponor.....	264
Fittings	
Galv Round Sheet Metal.....	182
Galv Sheet Metal.....	154, 160, 162, 165, 169, 179, 187, 192
Galv Sheet Metal.....	201, 203
Galv Sheet Metal.....	806

General Plastics Air Duct Fittings.....	157
General Plastics Underground Duct Fittings.....	158
Oval Galv Sheet Metal.....	152-153
Selkirk.....	824
Selkirk B-Vent.....	819-820
Selkirk B-Vent Oval.....	824
Selkirk Chimney Systems.....	822
Tubing Transition.....	265
Watts Radiant PEX Compression.....	271
Fixing Wire Uponor.....	266
Flame Safeguard	
Honeywell Pressure and Limit Controls.....	288
Honeywell Sensors.....	366
Flame Sensors	550
Flame Sensors	
Honeywell.....	366
Nordyne.....	567
Flange Sets Grundfos.....	301
Flanges	
Airtec.....	217
Isolation.....	452
Watts Regulator Isolation Pump.....	307
Flaring Tools	
Hilmor.....	729
Jones Stephens.....	590
Ridgid.....	589
Flashlights	
Klein Tools.....	596
Rayovac.....	595
Richard Specialty.....	594
Sensible Products.....	597
Spectroline Leak Detection.....	120
Flat Boring Accessories Milwaukee.....	580
Flat Boring Bits Milwaukee.....	580
Flex Duct	
Aluminum.....	803
Atco Insulated.....	146-147
Atco Insulated Sleeves.....	148
Atco Uninsulated Aluminum Duct.....	147
Flex Duct Connectors Duro Dyne.....	131
Flex Duct Cutters Malco.....	775
Flex Tube Kit Nordyne.....	38
Float Switches DiversiTech.....	89
Flow Center Accessories B&D Mfg Inc... ..	214
Flow Centers	
B&D Mfg Inc.....	214
Hydron Module.....	211
Flow Valves Taco Inc.....	302
Flowmeter Tool B&D Mfg Inc.....	214
Flowmeters B&D Mfg Inc.....	214
Flue Brushes Mill-Rose.....	643



Product Index

Flue Caps Versa Cap.....	804
Flush Valves Sloan.....	519, 521-522
Flushing Nu-Calgon System Flushing Products.....	80
Flushmate Replacement Parts Sloan....	526
Foil Duct Wrap	427
Foil Tape Polyken Technologies.....	135
Folding Rules Klein Tools.....	734
Folding Tools	
Klein Tools.....	778
Malco.....	773
Foot Valve Repair Kit Bradley.....	454
Frames Lenox Hacksaw.....	736
Franklin Electric	
Capacitors.....	479
Relays.....	479
Freeze Protection Controls Honeywell..	399, 423
Fresh Air Intake Sheet Metal.....	191
Fuel Filters General Filters.....	368
Fujitsu	
Ductless Split Systems.....	75
Halcyon Parts & Accessories.....	51, 53, 77
Multi-Zone Mini-Split Systems.....	54-55
Remote Controls.....	50, 77
Single Zone Mini-Split Systems.....	58, 62-64
Furnace Accessories Ruud Heating & AC551	
Furnace Filters	
Glasfloss.....	19
Honeywell Media.....	24
Furnaces Nordyne Gas.....	237-238, 247-249
Fuse Boxes For Type "T" Plug Fuses.....	351
Fuses	
DiversiTech.....	351
Ruud.....	350

G

Gaffer's Tape Polyken.....	135
Galeton	
Coated Gloves.....	833
Cotton Gloves.....	833
Drivers Gloves.....	833
Hearing Protection.....	833
Jersey Gloves.....	833
Leather Gloves.....	833
Respirators.....	833
Safety Glasses.....	841
Gallo Gun Condensate Drain Cleaners.....	88
Galv Sheet Metal Pipe & Ftgs.....	151

Galvanized Sheet Metal Panning Material.....	150
Gas Boilers Weil-McLain.....	258
Gas Combi Boilers Navien America Inc...	253
Gas Conversion Kits	
Reznor.....	508
Ruud.....	557
Gas Furnace	
Downflow.....	232
Multiposition.....	239-240
Upflow/Horizontal.....	241-242
Gas Furnaces Nordyne.....	237-238, 247-249
Gas Heaters Reznor.....	250
Gas Heating Boilers Navien America Inc.	253
Gas Leak Detector Chemicals	
Nu-Calgon.....	81
Oatey.....	117
Gas Packs Ruud Roof tops.....	68
Gas Unit Heater Accessories	
Diversitech.....	124
Gas Valves	
Honeywell Burner Controls.....	356
Honeywell Combination.....	355
Honeywell SmartValve.....	357
Nordyne.....	569
Reznor.....	508
Robertshaw.....	359
Ruud.....	516
Ruud Heating & AC.....	535
Gas Vent	
DuraVent.....	826
Selkirk.....	819-820, 822, 824
Gasket Rolls Ruud Neoprene.....	553
Gaskets	
Bell & Gossett.....	453
Lavelle.....	323
McDonnell and Miller.....	501
Ruud.....	728
Gasoil Leak Detectors.....	114
Gauges	
Apollo Water.....	322
Vacuum.....	724
Gauges & Meters Ruud.....	624
Gear Milwaukee.....	834
General Filters	
Air Cleaners.....	25
Fuel Filters.....	368
Humidifiers.....	15
Parts.....	480
General Plastics	
Air Duct Fittings.....	157



Product Index

Black Max Underground Duct Fittings....	158
Heat & Air Duct Pipe.....	156
General Wire Spring Co	
Augers Closet.....	602
Augers Urinal.....	602
Cable Connectors.....	688
Cable Cutters.....	688
Drain Cleaning.....	688
Drain Cleaning.....	689
Drain Cleaning.....	689
Flexicore Cable.....	688
Flexicore Wire Rope Center Augers.....	689
Lubricants Snake Oil.....	605
Replacement Cable.....	688
Sewer Rods.....	689
Tubing Cutter Autocut.....	661
GeneralAire Humidistats.....	480
Generators Honeywell.....	381
Genesis Cable Honeywell.....	407
Genesis Low Voltage Cable Honeywell.....	407
Geothermal	
B&D Mfg.....	214
B&D Mfg Inc.....	214
Geothermal Heat Pumps Hydron Module.....	205
Gerber Faucet Parts.....	481
Gibson	
Condensing Units.....	43
Gas Downflow Furnaces.....	233
Gas Upflow Furnaces.....	243
Heat Pumps.....	48
Glasfloss	
Filter Pads & Media.....	20
Filters.....	19, 210
Furnace Filters.....	19
Glasses Galeton Safety.....	841
Gloves	
Galeton Coated.....	833
Galeton Cotton.....	833
Galeton Drivers.....	833
Galeton Jersey.....	833
Galeton Leather.....	833
Jones Stephens.....	832
Klein Tools.....	828
Majestic Glove.....	830
Sioux Chief.....	829
Golden Tools RectorSeal.....	677, 798
Gooseneck Spouts Chicago Faucets.....	456
Grilles Shoemaker.....	220, 223, 226
Grinders Milwaukee.....	718
Grundfos	
Circulator Pumps.....	300
Flange Sets.....	301

Parts.....	301
Pumps.....	296, 298, 300
Timer Controls.....	301
Grundfos Pumps B&D Mfg Inc.....	213

H

Hacksaw Blades Lenox.....	737
Hacksaw Frames Lenox.....	736
Hacksaws Mini.....	749
Hackzall Blades Milwaukee.....	746
Hammer Drill Bits Milwaukee.....	584
Hammers	
Malco.....	598
Ridgid.....	599
Hand Tool	660
Hand Cleaners	
Harvey.....	439
Klein Tools.....	438
Hand Saws	
Lenox.....	736
Milwaukee.....	742
Hand Seamers Tools Klein Tools.....	778
Handi-Plugs Jones Stephens.....	648
Handle Adapter Kits Moen.....	502
Handles	
Chicago Faucets.....	455
Shoemaker.....	225
T&S Brass Faucet.....	528
Handy Box Utility.....	349
Hangers	
C & S Mfg Duct.....	142
Pipe.....	142
Hard Start Kits Ruud.....	106
Hardcast	
Damper Accessories.....	141
Duct Liner Adhesives.....	141, 424
Insulation Fasteners.....	434
Mastic Duct Sealants.....	140-141, 426
Hart & Cooley	
Air Connectors.....	144
Insulated Flexible Duct.....	145
Sleeves.....	145
Harvey	
Antifreeze.....	279
Drain Cleaning Chemicals & Tools.....	603
Hand Cleaners.....	439
Pipe Joint Lubricants.....	442
Hearing Protection Galeton.....	833
Heat Cells	537



Product Index

Heat Conductive Compound Honeywell 286

Heat Exchangers

Advanced Industrial Components..... 304
 Ruud..... 551
 Ruud Heating & AC..... 551
 Weil-McLain..... 303

Heat Guns Milwaukee..... 719

Heat Pumps..... 46-47

Heat Pumps

Comfort-Aire PTAC..... 67
 LG Electronics PTAC..... 65

Heat Recovery Ventilators

Lifebreath..... 7
 Lifebreath Indoor Wet Area..... 8

Heat Transfer Plates Uponor Quik Trak... 265

Heated Hand Warmers Milwaukee..... 838

Heated Hoodies Milwaukee..... 837

Heated Jackets Milwaukee..... 835

Heater Accessories Schwank..... 330

Heater Parts Schwank..... 330

Heaters

Hydron Module..... 212
 Reznor Unit..... 250
 Ruud Crankcase..... 108
 Schwank..... 330, 518
 Smith's Environmental Kickspace..... 251

Heating Controls Tekmar..... 292

Heatlines Maxifold Manifolds..... 252

Hercules

Anti-Freeze..... 283
 Leak Detectors..... 116

Hex Bits Malco..... 755

Hex Drivers Malco..... 755

Hex Key Sets Klein Tools..... 794

Hex Key Wrench Inserts Malco..... 795

Hex Keys Malco..... 795

Hex Wrenches Ridgid..... 789

Hilmor

Flaring Tools..... 729
 HVAC Tools..... 587, 662, 729,
 771
 Pliers..... 686
 Wire Strippers..... 686

Hoffman Specialty

Main Steam Vents..... 275
 Main Water Vents..... 275
 Radiator Steam Vents..... 275
 Steam Traps..... 317

Hole Cutters

Lenox One Tooth..... 609
 Malco..... 500, 774
 Milwaukee..... 610-611

Hole Saw Kits Milwaukee..... 610

Hole Saws

Lenox..... 607
 Malco..... 752
 Milwaukee..... 611

Hole-Hawg Drill Milwaukee..... 716

Honeywell

Air Cleaners..... 24
 Air Eliminators..... 274
 Aquastat Controllers..... 286
 Aquastat Relays..... 285
 Aquastats..... 284
 Aquatrol Boiler Controls..... 289
 Cable..... 407
 Commercial Thermostats..... 398
 Communicating Programmable
 Thermostats..... 420
 Contactors..... 102
 Damper Actuators..... 423
 Dampers..... 421
 Dehumidifiers..... 17
 Energy Recovery Ventilation Systems... 423
 EnviraZone System Saver Kit..... 420
 Environment Controls..... 396
 Fan and Limit Controls..... 364
 Fan Centers..... 484
 Flame Sensors..... 366
 Freeze Protection Controls..... 423
 Fresh Air Ventilators..... 423
 Gas Burner Controls..... 356
 Gas Valves..... 355
 Genesis Low Voltage Cable..... 407
 Humidifier Pads..... 13
 Humidifiers..... 13, 485
 Humidity Controllers..... 14
 Hydronic Switching Relays..... 372
 Igniters..... 362
 Media Air Cleaner..... 1
 Motorized Zone Valves..... 325
 Oil Primary Controls..... 365
 Outdoor Temperature Sensors..... 394
 Parts..... 486
 Parts & Accessories..... 286, 399, 486
 Pilot Burners..... 369
 Pilot Modules..... 413
 Power Generators..... 381
 Pressuretrol Controllers..... 288
 Relays..... 372
 Remote Temperature Controls..... 97, 288
 Replacement Media..... 24
 Sail Switches..... 2
 SmartValve..... 357



Product Index

Temperature Sensors.....	396, 420
Thermocouples.....	381
Thermometers.....	286
Thermostat Accessories.....	392
Thermostat Cover Plates.....	399
Thermostat Guards.....	392
Thermostatic Mixing Valves.....	270
Thermostats.....	380, 385-387, 389-391, 393, 419
Tracer Wire.....	408
Transformers.....	409
TrueZONE Kits.....	419
TrueZONE Panels.....	419
UV Air Purifier.....	1
Ventilators.....	12
Well Assemblies.....	286
Winter Watchman.....	399
Wireless Thermostats.....	392
Zone Control Accessories.....	423
Horizontal Kits Nordyne.....	28
Hose	
B&D Mfg Inc Geothermal.....	215
Chicago Faucets Pre-Rinse.....	455
Refrigerant.....	728
Hose End Valves Nibco.....	294
Hose Kits	
B&D Mfg Inc Geothermal.....	214
Hydron Module.....	211
Hoses Robinair Charging.....	727
Hot Surface Igniters Ruud Water Heater.....	514
HRVs Lifebreath.....	7
Humidifier Pads Honeywell.....	13
Humidifiers	
GeneralAire.....	15
Honeywell.....	13, 485
Humidistats	
GeneralAire.....	480
Honeywell.....	14
HVAC Tools Hilmor.....	587, 662, 729, 771
Hydrants Woodford Repair Parts.....	570
Hydraulic Separators SpiroTherm.....	277
Hydrolevel	
Boiler Controls.....	309
Low Water Cut-Offs.....	309
Water Feeders.....	309
Hydron Module	
A-Coils.....	209
Air Handlers.....	208
Filters.....	211
Flow Centers.....	211
Geothermal Heat Pumps.....	205

Heaters.....	212
Parts.....	212, 483
Storage Tanks.....	212
Hydronic Accessories Watts Radiant	
Manifold.....	271
Hydronic Controls	
Honeywell Aquastats.....	284
Honeywell Aquatrol.....	289
Honeywell Motorized Zone Valves.....	325
White-Rodgers.....	328
Hydronic Heating Weil-McLain.....	258
Hydronic Switching Relays Honeywell..	372
Hydronics Watts Regulator.....	318

I

Ice Machine Maintenance Nu-Calgon.....	440
Ice Traction Implus.....	845
Igniters	
Honeywell Gas.....	362
Nordyne.....	567
Robertshaw.....	363
Ruud.....	550
Ruud Hot Surface.....	514
Ignition Controls Honeywell Gas.....	355, 357
Ignition Controls & Other Boards Ruud	
Heating & AC.....	549
Ignition Modules Honeywell Gas.....	413
Ignitors & Flame Sensors Ruud Heating	
& AC.....	550
Implus Yaktrax Ice Traction.....	845
Indoor Air Quality Ruud.....	3
Indoor Heat Pumps Multi-Zone Mini Split	
Systems.....	55
Induced Draft Blower Ruud.....	537
Inducer Motors Ruud Heating & AC.....	537
Injection Kits Spectroline.....	120
Inline Fans Lifebreath.....	814
Inside Pipe Cutters Sioux Chief.....	668
Inspections Mirrors DiversiTech.....	640
Insta-Tack Hardcast Insulation Adhesive...	424
Installation Fittings Water-Right Inc.....	560
Installation Parts Kohler.....	488
Insulated Flexible Duct	
Atco Duct.....	146-148
Hart & Cooley.....	145
Insulation	
Fiberglass.....	428
Shoemaker.....	225
TVM.....	435
Insulation Accessories	431



Product Index

Insulation Adhesives Hardcast	
Insta-Tack.....	424
Insulation Contact Adhesives Jones	
Stephens.....	437
Insulation Fasteners	
Duro Dyne.....	139, 433
Hardcast.....	434
Insulation Tape Bramec.....	429
Internal Tubing Cutters Ridgid.....	658
Iron-Grip Hardcast.....	141
Insulation Flanges Bell & Gossett	
Check-Trol.....	452

J

Jab Saws Klein Tools.....	751
Johnson Controls	
Pressure Controls.....	104
Thermocouples.....	383
Jone Stephens Safety Hats.....	832
Jones Stephens	
Buckets.....	650
Caulk Gun.....	648
Caulking Tools.....	648
Caution Tape.....	649
Drill Bits.....	770
Dryer Vents.....	807
Dust Masks.....	832
Extension Cords.....	788
Flaring Tools.....	590
Gloves.....	832
Handi-Plugs.....	648
Insulation Contact Adhesives.....	437
Knee Pads.....	649
Levels.....	633
Marking Paints.....	649
Nipple Caddies.....	648
Nipple Extractors.....	648
Nuts.....	487
Packing.....	648
Pigtails.....	311
Pipe Cutters.....	667, 672
Pipe Insulation.....	437
Pipe Taps.....	674
Pliers.....	685
Probing Rod.....	648
Pry Bars.....	648
Putty Knives.....	629
Shop Towels.....	649
Sponges.....	650
Swedge Tools.....	590

Tape.....	353
Tools.....	750, 800
Trouble Lights.....	788
Washers.....	487
Wrenches.....	800
Journeyman Snips Klein Tools.....	779

K

Ken-Way Drain Cleaners.....	687
Kick Starts Ruud.....	106
Kickspace Heaters Smith's Environmental.....	251
Kitchen Accessories Delta.....	467
Kitchen Faucet Side Sprays Kohler.....	488
Kitchen Sprays Delta.....	464
Kits Ruud.....	106, 537, 553, 557
Klein Tools	
Adjustable Wrenches.....	794
Aviation Snips.....	779
Clamp Meters.....	623
Crimpers.....	778
Cushion Grip Nut Drivers.....	766
Cushion Grip Screwdrivers.....	765
Cutting & Notching Tools.....	779
Diagonal-Cutting Pliers.....	683
Electrical Testers.....	623
Flashlights.....	596
Folding Wood Rules.....	734
Gloves.....	828
Hand Cleaners.....	438
Hex Key Sets.....	794
Jab Saws.....	751
Journeyman Snips.....	779
Knives.....	630
Needle Nose Pliers.....	683
Notchers.....	778
Pocket Knives.....	630
Pump Pliers.....	683
PVC Cutters.....	666
Ratcheting Box Wrenches.....	794
Screw-Holding Screwdrivers.....	766
Screwdriver/Nut Driver.....	767
Sheet Metal Tools.....	778
Side-Cutting Pliers.....	683
Slip-Joint Pliers.....	683
Snips.....	779
Steel Tapes.....	734
Step-Drill Bits.....	768
Tool Bags.....	651
Tool Holders.....	651



Product Index

- Torpedo Levels..... 636
- Utility Knife Blades..... 630
- Utility Knives..... 630
- Wire Strippers/Cutters Tools..... 684
- Knee Pads** Jones Stephens..... 649
- Knives**
- Klein Tools..... 630
- Klein Tools Pocket..... 630
- Klein Tools Utility..... 630
- Lenox Utility..... 625
- Lutz Utility..... 631
- Malco Utility..... 626
- Milwaukee Utility..... 627
- Knockout Tools** Milwaukee..... 709
- Kohler**
- Faucet Valves..... 489
- Installation Parts..... 488
- Kitchen Faucet Side Sprays..... 488
- Parts & Accessories..... 491
- Sink Parts..... 491
- Toilet Parts..... 489
- Urinal Installation & Accessories..... 488
- Valve Repair & Accessories..... 489

L

- LA-CO**
- Leak Detectors..... 115
- Markers..... 644
- Lamps** UltraVation UV Replacement..... 5
- Latex Gloves** Disposable..... 829
- Lavatory Drains** Delta..... 459
- Lavelle**
- Gaskets..... 323
- Plungers..... 604
- Leak Detection Flashlights** Spectroline. 120
- Leak Detection Kits** Spectroline..... 120
- Leak Detector Chemicals**
- Nu-Calgon Gas..... 81
- Oatey..... 117
- Leak Detectors**
- Gasoil..... 114
- Hercules..... 116
- LA-CO..... 115
- Refrigeration Technologies Chemicals ... 119
- Robinair..... 118
- UEI Leak..... 620
- Lenox**
- Auger Bits..... 574
- Band Saw Blades..... 740

- Hacksaw Frames..... 736
- Hand Saws..... 736
- Hole Saws..... 607
- One Tooth Hole Cutters..... 609
- ProTool Lube..... 443
- Screwdrivers..... 754
- Snips..... 780
- Tools..... 792
- Tubing Cutters..... 659, 669
- Utility Knives..... 625
- Wrenches..... 792
- Leslie Locke Versa Cap**..... 804
- Levels**
- Jones Stephens..... 633
- Klein Tools Torpedo..... 636
- Malco..... 634
- Richard Specialty..... 635
- Ridgid..... 632
- LG Electronics**
- PTAC Accessories..... 65
- PTACs..... 65
- Li'l Nipper** Bramec Tubing Cutter..... 665
- Liberty Pumps** Condensate Pumps..... 344
- Lifebreath**
- Accessories..... 11
- Air Cleaners..... 8
- Controls..... 9
- Dampers..... 10
- Heat Recover Ventilators..... 8
- Heat Recovery Ventilators..... 7
- HRV..... 7
- HRVs..... 7
- Inline Fans..... 814
- Remote Controls..... 8
- Timers..... 8
- Vent Hoods..... 11
- Weatherhood Kits..... 11
- Lifestyle Controls & Timers** Lifebreath.. 9
- Light Bulbs** Bramec..... 785
- Limit Controls**
- Honeywell..... 364
- Nordyne Parts..... 567
- Reznor..... 508
- Rud Heating & Ac..... 539
- Line Set Covers** DiversiTech..... 122
- Liner Kits** Metalbest Chimney..... 805
- Lineset Fittings** Nordyne..... 568
- Little Giant** Condensate Pumps..... 343
- Lock 'N Load** Mill-Rose Heavy-Duty
 Drybox..... 643
- Low Water Cut-Offs**
- Hydrolevel..... 309



Product Index

McDonnell and Miller.....	308
LP Conversion Kits	
Nordyne.....	229
Rinnai.....	254
LP Kits Reznor.....	508
Lubricants	
DiversiTech.....	444
General Wire Spring Co Snake Oil.....	605
Pipe Joint.....	442
Sioux Chief Silicone.....	445
WD-40.....	446
Lutz	
Screwdrivers.....	764
Tools.....	631, 764

M

MA-Line	
Electrical.....	377
Refractometers.....	622
Test Equipment.....	622
Worklights.....	787
Magnetic Worklights MA-Line.....	787
Main Motors & ECM Heads Ruud	
Heating & AC.....	541
Majestic Glove Gloves.....	830
Make-Up Air Controls Skuttle.....	815
Malco	
Awls.....	773
Crimpers.....	775
Dividers.....	773
Drill Bits.....	576
Duct Tools and Accessories.....	773
Fiberglass Ductboard Tools.....	775
Foamboard Staplers.....	269
Folding Tools.....	773
Hammers.....	598
Hex Keys.....	795
Hole Cutters.....	500, 774
Levels.....	634
Measuring Tapes.....	732
Nut Drivers.....	755
Power Bits.....	755
Radiant Heat Tools.....	269
Ratchet Wrenches.....	795
REDLINE Hand Tools.....	774
Riveting Tools.....	775
Rivets.....	137
Saws.....	752
Screwdrivers.....	755
Screws.....	137

Scribers.....	773
Snipss.....	772
TurboShear Drills.....	773
Utility Knives.....	626
Manifold Accessories	
Uponor.....	262-263, 324
Watts Radiant.....	271
Manifolds	
Heatlines Maxifold.....	252
Ruud.....	728
Uponor EP.....	262
Uponor TruFLOW.....	262
Watts.....	271
Manometers UEI Digital Electronic.....	621
Markers	
LA-CO.....	644
Milwaukee.....	653
Marking Paints Jones Stephens.....	649
Mason Industries Vibration Pads.....	93
Maxifold Manifolds Heatlines.....	252
Maxitrol	
Pressure Regulator Accessories.....	370
Pressure Regulators.....	370
Maxstraps Nylon Cinch Straps.....	637
McDonnell and Miller	
Low Water Cut-Offs.....	308
Parts.....	501
Measurement Tools Milwaukee.....	617
Measuring Tapes Malco.....	732
Media Dynamic Air Cleaner.....	21
Media Air Cleaner Honeywell.....	1
Media Air Cleaners	
GeneralAire.....	25
Glasfloss Z-Line Replacement Media....	19
Honeywell.....	24
Media Air Filters Ruud.....	4, 22
Media Filters Honeywell.....	24
Metalbest Flexible Aluminum Liner Kits.....	805
MetalBest Gas B-Vent.....	819-820
Metalbestos	
Gas Vent.....	824
Gas Vent Oval Pipe & Fittings.....	824
Meters	
Clamp.....	623
MA-Line.....	622
Ruud.....	615, 619, 624
Mill-Rose	
Cleaning Brushes.....	643
Drybox.....	643
Flue and Boiler Tube Brushes.....	643
PVC Cable Saws.....	753
Tool Boxes.....	643



Product Index

Milwaukee

Arbors.....	613
Band Saw Blades.....	747
Band Saws.....	717
Bit Sets.....	577, 580-581, 760-761
Blade Sets.....	746
Blades.....	742
Boring Bit Sets.....	581
Carrying Cases.....	652
Cases.....	652
Circular Saw Blades.....	747
Circular Saws.....	716
Combo Tool Kits.....	712
Cordless Accessories.....	719
Cordless Batteries.....	719
Cordless Drills.....	699
Cordless Saws.....	704
Cordless Tools.....	591, 690, 695, 698, 704
Cut-Off Machine Accessories.....	721
Cutter Wheels.....	696
Drill Accessories.....	581, 614
Drill Bits.....	582, 584, 613
Drill Kits.....	715
Drills.....	714-716
Files.....	614
Flat Boring Accessories.....	580
Flat Boring Bits.....	580
Gear.....	834
Grinders.....	718
Hackzall Blades.....	746
Hammer Drill Bits.....	584
Hand Saws.....	742
Heat Guns.....	719
Heated Hand Warmers.....	838
Heated Hoodies.....	837
Heated Jackets.....	835
Hole Cutters.....	610-611
Hole Saw Kits.....	610
Hole Saws.....	611
Hole-Hawg Drill.....	716
Knockout Tools.....	709
Markers.....	653
Measurement Tools.....	617
Misc. Tools.....	718
Miscellaneous Power Tools.....	699
Nut Drivers.....	761-762
Pilot Bits.....	613
Pliers.....	678

Power Tools.....	591, 610, 617, 690, 695, 698-699, 704, 706, 709-710, 712, 714-718
Reciprocating Saws.....	716
Replacement Bulbs.....	593
Right Angle Drills.....	715
Sanders.....	718
Sawzall & Hackzall Accessories.....	746
Sawzall Blade Sets.....	746
Sawzall Blades.....	742
Sawzall Reciprocating Saws.....	716
Screwdrivers.....	756
SDS Accessories.....	583
Shear & Nibble Accessories.....	746
Shockwave Bits Sets.....	577, 760
Shockwave Impact Duty Bits.....	759
Shockwave Nut Driver.....	761
Snips.....	776
Step Drill Bits.....	582
Super Hawg Drills.....	715
Temperature Guns.....	719
Test Tools.....	617
Thunderbolt Bits.....	580
Tool.....	660
Tools.....	577, 580-584, 591, 593, 610-611, 613-614, 617, 652, 690, 695-696, 698-699, 704, 706, 709-710, 712, 714-716, 718-719, 742, 746-747, 759-761
Tubing Cutters.....	663
Utility Knives.....	627
Voltage Detectors.....	617
Work Gloves.....	827
Milwaukee Electric Parts.....	721
Milwaukee Power Tools	704
Milwaukee Power Tools ,.....	704, 706
Milwaukee Power Tools	706
Milwaukee Tools ,.....	706
Milwaukee Tools	706
Mini-Split Drain Lines DiversiTech.....	122
Mini-Split Systems Single Zone.....	58, 62-64
Mirrors	
DiversiTech Telescoping.....	640
Ruud.....	641
Misc. Parts & Accessories Ruud	
Heating & AC.....	547, 553
Misc. Tools Milwaukee.....	718
Miscellaneous Power Tools Milwaukee.....	699



Product Index

Mixing Controls Tekmar.....	292
Mixing Valves Honeywell Thermostatic.....	270
Moen	
Faucet Cartridges.....	502
Parts & Accessories.....	502, 504
Motor Blade & Wheel Pullers Sensible Products.....	802
Motor Brackets DiversiTech.....	558
Motor Couplers Bell & Gossett.....	452
Motor Testers Ruud.....	615
Motors	
Bell & Gossett Pump.....	452
DiversiTech.....	558
Honeywell.....	486
Nordyne.....	568
Reznor.....	509
Ruud.....	374
Ruud ECM.....	541
Mounting Blocks Bramec Furnace.....	96
Mounting Brackets	
DiversiTech.....	94
Reznor.....	329
ThermO Mfg.....	123
Multi-Zone Mini Split Systems	
Indoor Heat Pumps.....	55
Outdoor Heat Pumps.....	54
Multi-Zone Mini-Split Systems Fujitsu....	54-55
Multimeters UEI.....	620
Multiposition Gas Furnace	239-240

N

Navien Parts.....	507
Navien America Inc	
Gas Combi Boilers.....	253
Gas Heating Boilers.....	253
Needle Nose Pliers Klein Tools.....	683
Neoprene Gasket Rolls Ruud.....	553
Nibco	
Boiler Drains.....	294
Hose End Valves.....	294
Nipple Boxes	
Pasco.....	646
Richard Specialty.....	647
Nipple Caddies Jones Stephens.....	648
Nipple Extractors Jones Stephens.....	648
Nipples T&S Brass Supply.....	528
Nordyne	
Air Conditioners.....	44-45
Gas Furnaces.....	237-238, 247-249

Parts.....	28, 229, 567-569
Residential Indoor Coils.....	38-39
Split Systems.....	44-45, 237-238, 247-249
TXV Kits.....	38
Notchers	
Klein Tools.....	778
Malco.....	774
Notching & Cutting Tools Klein Tools....	779
Notching Snips Klein Tools.....	779
Nozzles	
Oil Burner.....	367
T&S Brass Faucet.....	528
Nu-Calgon	
Coil Cleaners.....	80
Gas Leak Detectors.....	81
Ice Machine Maintenance.....	440
Refrigeration Flush Solvents.....	80
Refrigeration Oil Test Kits.....	726
Water Treatment Products.....	87
Nut Drivers	
Klein Tools Cushion Grip.....	766
Klein Tools Screwdriver/Nut Driver Combos.....	767
Malco.....	755
Milwaukee.....	761-762
Nut Splitters Seekonk.....	799

O

Oatey Leak Detector Chemicals.....	117
Oil Burner Nozzles Delavan.....	367
Oil Burners Honeywell Oil Primary Controls.....	365
Oil Filter Cartridges General Filters.....	368
Oil Filters General Filters.....	368
Oil Test Kits Nu-Calgon Refrigeration.....	726
Orifices Nordyne.....	568
Outdoor Heat Pumps Multi-Zone Mini Split Systems.....	54
Outlets Chicago Faucets.....	456

P

P-Traps Condensate.....	348
Package Gas/Electric Units Ruud.....	68
Packaged Terminal Air Conditioners LG Electronics.....	65
Packing Jones Stephens.....	648



Product Index

Paint Shoemaker..... 225

Panasonic

- EcoVent Fans..... 812
- Switches..... 812
- Ventilating Bath Fans..... 809, 811

Panning Material

- Galvanized Sheet Metal..... 150
- Southwark..... 150

Pans DiversiTech Drain..... 92

Paragon Electric Commercial Refrigeration Defrost Controls..... 98

ParFlush Kit Parker Hannifin..... 85

Parker Hannifin

- Filter-Driers..... 112
- Furnace Cement..... 342
- ParFlush Kit..... 85
- Solenoid Valves..... 107

Parts

- Hydron Module..... 212, 483
- Triangle Tube..... 531

Parts & Accessories Exhaust Fans..... 812

Pasco

- Drill Bits..... 586
- Tools..... 586, 646, 797

Permanant Filters..... 18

PEX

- Staples..... 271
- Uponor Clips..... 266
- Uponor Installation..... 266
- Uponor Uncoiler..... 267

PEX Fittings Watts Radiant Compression . 271

Pigtails Jones Stephens..... 311

Pilot Assemblies Ruud Water Heater 514

Pilot Bits Milwaukee..... 613

Pilot Burners Honeywell..... 362, 369

Pilot Gas Valves Honeywell..... 355

Pilot Igniters Robertshaw..... 363, 415

Pilot Modules Honeywell..... 413

Pilot Relight Kits Robertshaw..... 415

Pilots Reznor..... 509

Pilots & Orifices Ruud Heating & AC..... 552

Pilots & Thermocouples Robertshaw..... 382

Pipe

- Aluminum Flex Duct..... 803
- Aluminum Round..... 803
- Dryer Venting..... 803
- Galv Sheet Metal..... 184
- Galv Snap Lock Pipe..... 184
- General Plastics Heat & Air Duct..... 156
- Oval Galv Sheet Metal..... 152-153
- Selkirk Gas Vent..... 819-820, 824

Pipe Brackets Basset..... 142

Pipe Covering..... 428

Pipe Cutter Parts Ridgid..... 671

Pipe Cutter Wheels Ridgid..... 671

Pipe Cutters

- Jones Stephens..... 667, 672
- Klein Tools..... 666
- Ridgid..... 670-671

Pipe Dies Ridgid..... 676

Pipe Extractors Ridgid..... 675

Pipe Fittings

- Selkirk Chimney Systems..... 822
- Selkirk Gas Vent..... 819-820, 824

Pipe Hangers C & S Mfg..... 142

Pipe Inspecting Ridgid..... 722

Pipe Insulation Jones Stephens..... 437

Pipe Joint Lubricants Harvey..... 442

Pipe Shredders RectorSeal..... 677

Pipe Strap Basset..... 142

Pipe Tape Agri Drain..... 354

Pipe Taps Jones Stephens..... 674

Pipe Tools Ridgid..... 675

Pipe Wrenches RectorSeal..... 798

Pipeline Accessory Products Polyken Technologies..... 432

Pistons Aspen Mfg..... 37

Plaster Frame Sheet Metal..... 167

Plenum..... 155

Plenum Galv Sheet Metal..... 154

Pliers

- Hilmor..... 686
- Jones Stephens..... 685
- Klein Tools Diagonal-Cutting..... 683
- Klein Tools Needle Nose..... 683
- Klein Tools Pump..... 683
- Klein Tools Side-Cutting..... 683
- Klein Tools Slip-Joint..... 683
- Milwaukee..... 678
- Richard Specialty..... 682
- Ridgid..... 680
- Sioux Chief Slip Joint..... 681

Plumber's Box of Parts Delta..... 471

PlumBest Safety Glasses..... 840

Plungers

- Lavelle..... 604
- Sioux Chief..... 606

Pocket Knives Klein Tools..... 630

Polyken Technologies

- Duct Tape..... 134
- Foil Tape..... 135
- Pipeline Accessory Products..... 432

Pool/Spa Heat Recover Ventilators

- Lifebreath..... 8



Product Index

Power Adapters Ruud.....	615
Power Bits Malco.....	755
Power Generators Honeywell.....	381
Power Threaders Ridgid.....	676
Power Tools	
Klein Tools Drill Bits.....	768
Milwaukee.....	591, 610, 617, 690, 695, 698-699, 704, 706, 709-710, 712, 714-718
Pre-Rinse Faucet Parts Chicago Faucets	455
Pre-Rinse Hose Chicago Faucets.....	455
Pressure Controls Johnson Controls.....	104
Pressure Controls	
Honeywell Pressuretrol.....	288
Ranco.....	99
Pressure Reducing Valves Bell & Gossett.....	312
Pressure Regulator Accessories	
Maxitrol.....	370
Pressure Regulators	
Maxitrol.....	370
Watts Regulator Boiler Feed.....	278, 310, 313
Pressure Switches	
Nordyne.....	568
Reznor.....	509
Ruud Heating & AC.....	549
Pressuretrol Honeywell Controllers.....	288
Prestige Parts Triangle Tube.....	531
Prinsco	
Accessories.....	449
Sump Basins.....	449
Pro-Fit™ Replacement Parts Taco.....	529
Pro1 IAQ	
Thermostat Accessories.....	401
Thermostats.....	400
Probes Ruud.....	616
Probing Rod Jones Stephens.....	648
Protech	
Alkaline Battery Pack.....	641
Batteries.....	641
Safety Glasses.....	839
Protectorelay Honeywell Oil Primary.....	365
Pry Bars Jones Stephens.....	648
PTAC Accessories LG Electronics.....	65
PTACs	
Comfort-Aire.....	67
LG Electronics.....	65
Pump Flanges Watts Regulator.....	307
Pump Motors Bell & Gossett.....	452
Pump Oils Vacuum.....	728
Pump Parts Zoeller.....	573

Pump Pliers Klein Tools.....	683
Pump Seals Bell & Gossett.....	452
Pumps	
Circulator.....	296, 298, 300
DiversiTech Condensate.....	345
EZ Trap Condensate.....	346
Grundfos.....	300
Grundfos Flow Center.....	213
Liberty Condensate.....	344
Liberty Pumps Condensate.....	344
Little Giant Condensate.....	343
Punches Snap Lock for Siding.....	774
Putty Knives Jones Stephens.....	629
PVC Air Duct General Plastics.....	157
PVC Cutters Klein Tools.....	666
PVC Pipe Saws Ridgid.....	741
PVC Underground Duct General Plastics	
Black Max.....	158

Q

Quik Trak Joist Trak.....	265
----------------------------------	-----

R

Radiant Heat Tools Malco.....	269
Radiator Coin Key Air Valves Jones Stephens.....	276
Radiator Steam Valves Watts Regulator.	318
Radiator Steam Vents Hoffman Specialty	275
Radiator Valves Webstone.....	315
Radon Mitigation Fans Fantech.....	447
Ranco	
Commercial Refrigeration Controls.....	99
Commercial Temperature Controls.....	99
Ratchet Wrenches Malco.....	795
Rayovac	
Batteries.....	595
Flashlights.....	595
Razorback Wrenches.....	796
RCD Corp Mastic Adhesives.....	143
Reach-It Telescoping Tool.....	640
Reamers Ridgid.....	675
Receptacles Electrical.....	349
Reciprocating Saw Blades Lenox.....	737
Reciprocating Saws Milwaukee.....	716
Recirculation Pumps Grundfos.....	297
Rectangular Boots Sheet Metal.....	167
Rectangular Elbows Sheet Metal.....	163



Product Index

RectorSeal
 Air Diffusers..... 217, 228
 Ceiling Support Flanges..... 217
 Golden Tools..... 677, 798

Red Devil Silicone Sealants..... 816

RedLINK Honeywell Wireless Adapter 419

Reducers
 Sheet Metal..... 167, 191-192
 Spiral Duct..... 196

Reflective Insulation TVM..... 435

Refractometers MA-Line..... 622

Refrigerant Ball Valves..... 126

Refrigerant Leak Detectors
 Refrigeration Technologies Chemicals ... 119

Refrigerant Piping & Components
 Ruud..... 723

Refrigerant Recovery DiversiTech..... 84

Refrigerant Scales Ruud..... 723

Refrigeration Controls
 Johnson Pressure Controls..... 104
 Ranco..... 99

Refrigeration Flush Solvents
 Nu-Calgon..... 80

Refrigeration Hoses..... 730

Refrigeration Oil Test Kits Nu-Calgon... 726

Refrigeration Recovery Nu-Calgon
 Flushing Products..... 80

Refrigeration Technologies Leak
 Detectors..... 119

Refrigeration Temperature Controls
 Honeywell..... 97, 288

Register Boots Sheet Metal..... 174

Registers Shoemaker..... 223

Regulators Maxitrol Accessories..... 370

Relays
 Franklin Electric..... 479
 Honeywell..... 372
 Honeywell Aquastat..... 285
 Honeywell Hydronic Switching..... 372
 Nordyne..... 568
 Ruud..... 545-546
 Ruud Heating & AC..... 544
 Ruud Time Delay..... 545-546
 Start..... 545
 Taco Inc..... 290
 Uponor Pump..... 268

Relief Valves Bell & Gossett..... 312

Remote Controls
 Fujitsu..... 50, 77
 Lifebreath..... 8

Remote Dehumidists..... 10

Renewing Kits Chicago Faucets..... 457

Replacement Blades Sioux Chief..... 749

Replacement Bulbs Milwaukee..... 593

Replacement Filters Elkay..... 476

Replacement Media Air Filter..... 23

Replacement Parts
 Ruud Heating & Ac..... 553
 Sloan Flushmate..... 526
 Water-Right Inc..... 560

Respirators Galeton..... 833

Restrictors Nordyne..... 568

Retrieving Tools Reach-It Telescoping.... 640

Return Air Drops Galv Sheet Metal..... 154

Return Air Panning ThermO Mfg..... 130

Return Air Products Sheet Metal..... 167-168

Reznor
 Gas Conversion Kits..... 508
 Gas Valves..... 508
 Limit Controls..... 508
 Motors..... 509
 Mounting Brackets..... 329
 Parts..... 510
 Pilots..... 509
 Pressure Switches..... 509
 Transformers..... 510
 Unit Heaters..... 250
 Vent Caps..... 510

Rheem
 Draft Inducer Blowers..... 538
 Evaporator Coils..... 30

Rhomar Boiler Treatments..... 280

Richard Specialty
 Drain Flushers..... 600
 Flashlights..... 594
 Levels..... 635
 Nipple Boxes..... 647
 Pliers..... 682
 Suction Gun..... 600
 Tape Measures..... 733
 Taps..... 673
 Wrenches..... 793

Ridgid
 Abrasive Saws..... 741
 Adjustable Wrenches 790
 Hammers..... 599
 Levels..... 632
 Manual Threaders..... 676
 Pipe Cutters..... 670-671
 Pipe Inspecting..... 722
 Pipe Tools..... 675
 Pliers..... 680
 Power Threaders..... 676
 Rulers..... 735
 Saws..... 741



Product Index

Shovels.....	783
Tools.....	675, 781, 789
Tubing Cutters.....	657, 664
Tubing Tools.....	589, 658
Vises.....	781
Wrenches.....	789
Right Angle Drills Milwaukee.....	715
Rinnai	
Boilers.....	254
LP Conversion Kits.....	254
Parts.....	511
Tankless Water Heater Accessories.....	511
Riveting Hammers Malco.....	598
Riveting Tools Malco.....	775
Rivets Malco.....	137
Robertshaw	
Air Sensor Switches.....	332
Gas Valves.....	359
Pilot Igniters.....	363, 415
Pilot Relight Kits.....	415
Thermocouples & Pilots.....	382
Transformers.....	411
Robinair	
Charging Hoses.....	727
Leak Detectors.....	118
Roll-out Switches Nordyne.....	568
Roof Curb Adapters Ruud.....	73
Roof Curbs Ruud.....	73
Round Boots Sheet Metal.....	172
Round Collars Sheet Metal.....	159, 177
Round Elbows Sheet Metal.....	181
Round Pipe Sheet Metal.....	183
Round Takeoffs Sheet Metal.....	185
Round Tees Sheet Metal.....	188
Round Wye Sheet Metal.....	188
Rulers Ridgid.....	735
Rules	
Klein Tools Folding Wood.....	734
Ridgid.....	735
Rust Inhibitors Rust-Raider.....	281
Rust-Raider Rust Inhibitors.....	281
Ruud	
Accessories.....	34, 73, 106, 128, 378, 555, 557
Adhesives & Sealants.....	82
Air Cleaners.....	4
Air Movement.....	133
Capacitors.....	338, 340
Chemicals.....	3, 82, 86, 645, 725
Choke.....	553

Coil Cleaners.....	82-83
Commercial Water Heater Parts.....	516
Condensate Overflows.....	91
Contactors.....	103
Controls.....	101
Crankcase Heaters.....	108
Evaporator Coils.....	31
Filter Kits.....	557
Filter-Driers.....	109-110, 113
Fuses.....	350
Gas Valves.....	516
Hardware.....	361, 374, 616
Indoor Air Quality.....	3
Meters.....	615, 619, 624
Motor Testers.....	615
Motors.....	374, 542
Package Gas/Electric Units.....	68
Parts.....	378
Parts & Accessories.....	16, 91, 412
Refrigerant Piping & Components.....	723
Repair & Replacement Parts.....	22, 125, 555, 557, 728
Scroll Compressors.....	534
Sealing Caps.....	79
Sight Glasses.....	127
Smoke Detectors & Accessories.....	615
Start Capacitors.....	339
Thermocouples.....	516
Thermostat.....	403
Thermostats.....	403, 405, 514-515
Tools/Gauges/Solder.....	728, 786
Valves.....	129, 724
Warranty Upgrades.....	516
Water Heater Parts.....	513
Wire Ties.....	417
Ruud Heating & AC	
Blower Wheels.....	533
Burners.....	553
Compressors.....	533
Door Switches.....	552
Drain Pans.....	552
Expansion Valves.....	534
Fan Blades.....	535
Filter Cores.....	551
Furnace Accessories.....	551
Gas Valves.....	535
Ignition Controls & Other Boards.....	549
Ignitors & Flame Sensors.....	550
Inducer Motors.....	537
Ruud Heating & Ac Limit Controls.....	539
Ruud Heating & AC	
Main Motors & ECM Heads.....	541



Product Index

Misc. Parts & Accessories.....	547, 553
Pilots & Orifices.....	552
Relays.....	544
Ruud Heating & Ac Replacement Parts...	553
Ruud Heating & AC Sequencers.....	546
Ruud Heating & Ac Service Valves.....	547
Ruud Heating & AC	
Solid Furnace Bottoms.....	552
Traps & Connectors.....	551

S

Saddles	
Sheet Metal.....	193
Spiral Duct.....	198
Safety Glasses	
Galeton.....	841
PlumBest.....	840
Protech.....	839
Safety Hats Jone Stephens.....	832
Safety Relief Valves Bell & Gossett.....	312
Safety Systems Uponor.....	204
Sail Switches Honeywell.....	2
Sanders Milwaukee.....	718
Sanuvox	
Air Purifiers.....	6
UV Replacement Bulbs.....	6
Saw Blades	
Lenox.....	736
Lenox Reciprocating.....	737
Malco.....	752
Ridgid.....	741
Saws	
Hacksaws.....	749
Jab.....	751
Jones Stephens.....	750
Lenox Hacksaw.....	736
Lenox Hand.....	736
Lenox Hole.....	607
Malco Hole.....	752
Milwaukee.....	742
Milwaukee Band.....	717
Ridgid.....	741
Ridgid PVC Pipe.....	741
Sawzall Blade Sets Milwaukee.....	746
Sawzall Blades Milwaukee.....	742
Scales Ruud Refrigerant.....	723
Schwank	
Tube Heater Parts & Accessories.....	330
Tube Heaters.....	330, 518

Scotch 3M Electrical Tape.....	352
Scratch Awls Malco.....	773
Screw-Holding Screwdrivers Klein	
Tools.....	766
Screwdriver/Nut Driver Klein Tools.....	767
Screwdrivers	
Klein Tools Cushion Grip.....	765
Klein Tools Screw-Holding.....	766
Lenox.....	754
Lutz.....	764
Malco.....	755
Milwaukee.....	756
Screws	
Malco.....	137
Shoemaker.....	225
Scribers Malco.....	773
Scroll Compressors	533
Scroll Compressors Copeland.....	534
SDS Accessories Milwaukee.....	583
Sealants	
Harvey.....	341
Silicone.....	816-817
Uponor Quik Trak.....	267
Seals Bell & Gossett Pump.....	452
Seamers Malco.....	774
Seekonk	
Nut Splitters.....	799
Torque Wrenches.....	799
Selkirk	
B-Vent Oval Pipe & Fittings.....	824
B-Vent Pipe & Fittings.....	819-820
Chimney Systems.....	822
Gas Vent.....	824
Sensible Products	
Flashlights.....	597
Motor & Wheel Pullers.....	802
Slide Driver.....	769
Sensors	
Honeywell Flame.....	366
Honeywell Temperature.....	396, 420
Ruud.....	548
Tekmar.....	293
Sentinel Weil-McLain Boiler Parts.....	566
Sequencers Ruud Heating & AC.....	546
Service Tools	730
Service Valves	
Nordyne.....	569
Ruud Heating & Ac.....	547
Setpoint Controls Tekmar.....	292
Setting Hammers Malco.....	598
Sewage Basins Topp Industries.....	448
Sewer Rods General Wire Spring Co.....	689



Product Index

Shanks Chicago Faucets.....	457
Shear & Nibble Accessories Milwaukee	746
Sheet Metal	
Caps.....	167
Dampers.....	190
Drawbands.....	190
End Caps.....	190
Fresh Air Intake.....	191
Oval Galv Sheet Metal.....	152-153
Plaster Frame.....	167
Rectangular Boots.....	167
Rectangular Elbows.....	163
Reducers.....	167, 191
Return Air Products.....	167
Round Boots.....	172
Round Pipe.....	183
Round Takeoffs.....	185
Round Tees.....	188
Round Wye.....	188
Spiral Connectors.....	195
Spiral Duct Caps.....	197
Spiral Duct Reducers.....	196
Spiral Duct Saddles.....	198
Spiral Duct Shoe Tap.....	199
Spiral Pipe.....	194
Stack Boots.....	202
Vent Saddles.....	191
Wall Stack Elbows.....	202
Wallstack Duct.....	200
Sheet Metal Fittings Galv.....	160, 162, 165, 169, 182
Sheet Metal Pipe Galv.....	184
Sheet Metal Tools	
Hilmor.....	782
Klein.....	778
Sheet Steel Flat.....	149
Shockwave Bits Sets Milwaukee.....	577, 760
Shockwave Impact Duty Bits Milwaukee	759
Shockwave Nut Driver Milwaukee.....	761
Shoe Covers	843-844
Shoe Covers	
Booties Protectors.....	843
Bramec.....	842
Sioux Chief.....	844
Shoe Tap Spiral Duct.....	199
Shoemaker	
Accessories.....	225
Bits.....	225
Dampers.....	218, 221
Diffusers.....	218, 220, 224, 227
Grilles.....	220, 223, 226

Handles.....	225
Insulation.....	225
Paint.....	225
Registers.....	223
Screws.....	225
Shop Towels Jones Stephens.....	649
Shovels	
Bully Tools.....	784
Ridgid.....	783
Shower Parts Delta.....	468
Shower Stall Parts EL Mustee.....	506
Showerheads Sloan.....	523
Siding Tools Malco Punches.....	774
Sight Glasses Ruud.....	127
Silicone Lubricants Sioux Chief.....	445
Silicone Sealant Chatham Brass.....	817
Silicone Sealants Red Devil.....	816
Silver King Mfg	
Boiler Additives.....	282
Boiler Cleaners.....	282
Single Handle Repair Kits Delta.....	459
Single Zone	
Air Handler Units.....	49
Condensing Units.....	49
Mini-Split Systems.....	58, 62-64
Single Zone Mini-Split Systems Fujitsu	58, 62-64
Sink Drains Delta.....	459
Sink Wastes T&S Brass Waste Valve.....	528
Sioux Chief	
Condensate Traps.....	348
Plungers.....	606
Replacement Blades.....	749
Saws.....	749
Tie Downs.....	656
Tools.....	749
Tube and Pipe Cutters.....	668
Vacuum Gauges.....	731
Work Gloves.....	829
Skuttle Make-Up Air Controls.....	815
Sleeves	
Atco Insulated Duct.....	148
Hart & Cooley.....	145
Slide Driver Sensible Products.....	769
Slip Joint Pliers Sioux Chief.....	681
Sloan	
Flush Valves.....	519, 521-522
Flushmate Replacement Parts.....	526
Optima Parts.....	523
Parts.....	524
Showerheads.....	523
Transformers.....	523



Product Index

Sloan Flushmate Replacement Parts..... 526

SmartValve Honeywell..... 357

Smith's Environmental Kickspace
Heaters..... 251

Smoke Emitters Bramec..... 373

Smoke Testers Bramec..... 373

Snap Lock Punch Klein Tools..... 779

Snips
Klein Tools..... 779
Lenox..... 780
Milwaukee..... 776
Ridgid..... 781

Snipss Malco..... 772

Soap/Lotion Dispenser Accessories
Delta..... 466

Soil Pipe Cutters Ridgid..... 670

Solenoid Assemblies Ruud..... 553

Solenoid Valves Parker Hannifin..... 107

Solid Furnace Bottoms Ruud Heating &
AC..... 552

Southwark Panning Material..... 150

Spades Bully Tools..... 784

Speakman Parts..... 527

Specialty Vent Deflect-O..... 216

Spectroline
Cartridges..... 121
Dye Capsules..... 121
Injection Kits..... 120
Leak Detection..... 120

Speedi-Boot Boot Hangers..... 171

SpeediChannel Line Set Covers
DiversiTech..... 122

Spiral Connectors Sheet Metal..... 195

Spiral Duct
Caps..... 197
Reducers..... 196
Saddles..... 198
Shoe Tap..... 199

Spiral Duct Caps Sheet Metal..... 197

Spiral Duct Reducers Sheet Metal..... 196

Spiral Duct Saddles Sheet Metal..... 198

Spiral Duct Shoe Tap Sheet Metal..... 199

Spiral Elbows Sheet Metal..... 194

Spiral Pipe Sheet Metal..... 194

Spiral Tees Sheet Metal..... 195

Spiralink Couplers..... 319

SpiroTherm
Air Eliminators..... 277
Air Releases..... 277
Dirt Separators..... 277
Hydraulic Separators..... 277
Valves..... 277

Spirotop SpiroTherm..... 277

Spirovent SpiroTherm..... 277

Sponges Jones Stephens..... 650

Spotter Pins Duro Dyne..... 139

Spouts
Chicago Faucets..... 456
Chicago Faucets Gooseneck..... 456

Sprays
Delta Kitchen..... 464
Kohler Kitchen..... 488

Sprinklers Uponor..... 204

Stack Boots Sheet Metal..... 202-203

Stack Caps Versa Cap..... 804

Stands Bramec Equipment..... 96

Staplers Malco..... 269

Staplers and Staples Uponor..... 267

Staples PEX..... 271

Start Capacitors Ruud..... 339

Start Collars..... 179

Start Relays Ruud..... 545

Steam Traps Hoffman Specialty..... 317

Steam Vents Hoffman Specialty Main..... 275

Step Drill Bits Milwaukee..... 582

Stop Leak Silver King Mfg Boiler..... 282

Storage Tanks Hydron Module..... 212

Strap
Basset..... 142
DiversiTech..... 638
Rubber Tie-Down..... 638

Strap Wrenches Ridgid..... 789

Straps Maxstraps..... 637

Stuff Sorter Bucket Organizers..... 655

Suction Gun Richard Specialty..... 600

Sump Basins Prinsco..... 449

Super Hawg Drills Milwaukee..... 715

SuperVent Honeywell Air Eliminators..... 274

Swaging Tools..... 729

Swedge Tools Jones Stephens..... 590

Switches
Bramec Electrical..... 349
Condensate Overflow..... 89
Panasonic..... 812
Pressure..... 509
Robertshaw Air Sensing..... 332
Ruud Water Heater..... 514
Zoeller Pump..... 573

Switching Relays Honeywell Hydronic..... 372

Swoosh CO2 Cartridges..... 88

SX-Extrol Amtrol Standard Expansion
Tanks..... 320

System Flushing Products Nu-Calgon.. 80

T

T&S Brass

Faucet Handles.....	528
Faucet Nozzles & Gooseneck.....	528
Faucet Parts.....	528
Faucet Repair Kits.....	528
Parts & Accessories.....	528

Taco Pro-Fit™ Replacement Parts.....	529
---	------------

Taco Inc

Flo-Checks.....	302
Zone Controls.....	290
Zone Valve Power Head.....	327
Zone Valves.....	327

Takeoffs Galv Sheet Metal.....	187
---------------------------------------	------------

Tanks

Amtrol.....	320-321
Amtrol Expansion.....	320
Extrol Expansion.....	320
Hydron Module.....	212
SX-Extrol Expansion.....	320
Therm-X-Trol Expansion.....	320

Tapco

Bath/Faucet Repair Parts.....	450
Faucet Parts.....	450
Repair Parts.....	450

Tape

Agri Drain.....	354
Bramec Insulation.....	429
Insulation Accessories.....	136
Jones Stephens.....	353
Polyken Gaffer's.....	135
Polyken Technologies Duct.....	134
Polyken Technologies Foil.....	135
Scotch 3M Super 33+ Electrical.....	352

Tape Measurers Malco.....	732
----------------------------------	------------

Tape Measures

Klein Tools.....	734
Richard Specialty.....	733

Taps Richard Specialty.....	673
------------------------------------	------------

Tees Sheet Metal.....	189
------------------------------	------------

Tekmar

Boiler/DHW Controls.....	292
Heating Controls.....	292
Sensors.....	293
Setpoint Controls.....	292
Snow Melting Controls.....	292
Thermostats.....	292

Temperature Controllers Electronic

Remote.....	288
-------------	-----

Temperature Controls

Honeywell Remote Temperature.....	97, 288
Ranco.....	99

Temperature Guns Milwaukee.....	719
--	------------

Temperature Sensors Honeywell.....	394, 396, 420
---	----------------------

Tensioning Tools Malco.....	775
------------------------------------	------------

Terminal Kits MA-Line.....	377
-----------------------------------	------------

Test Equipment

MA-Line.....	622
UEI.....	620-621

Test Tools Milwaukee.....	617
----------------------------------	------------

Testers Bramec Smoke.....	373
----------------------------------	------------

Therm-X-Trol Expansion Tanks.....	320
--	------------

Thermal Expansion Valves

Aspen Mfg.....	37
Ruud.....	534

ThermO Mfg

ThermO-Frames.....	130
ThermO-Headers.....	130
ThermO-Pan Return Air Panning.....	130
ThermO-Snap Clamps.....	123

ThermO-Frames ThermO Mfg.....	130
--------------------------------------	------------

ThermO-Headers ThermO Mfg.....	130
---------------------------------------	------------

Thermocouples

Honeywell.....	381
Johnson Controls.....	383
Ruud.....	516

Thermocouples & Pilots Robertshaw.....	382
---	------------

Thermolec

Electric Boilers.....	255
Parts & Accessories.....	530

Thermometers

Honeywell.....	286
UEI.....	620

Thermostat Ruud.....	403
-----------------------------	------------

Thermostat Cover Plates Honeywell.....	399
---	------------

Thermostat Guards Honeywell.....	392
---	------------

Thermostat Shanks Ruud.....	515
------------------------------------	------------

Thermostatic Expansion Valves

Nordyne.....	569
--------------	-----

Thermostatic Mixing Valves Honeywell.....	270
--	------------

Thermostatic Steam Traps Hoffman

Specialty.....	317
----------------	-----

Thermostats

Bramec.....	379
ecobee.....	384
Honeywell.....	380, 385-387, 389-391, 393, 396, 419

Honeywell Commercial.....	398
---------------------------	-----

Honeywell Commercial Programmable..	420
-------------------------------------	-----

Honeywell Communicating.....	420
------------------------------	-----

Honeywell Wireless.....	392
-------------------------	-----



Product Index

Pro1 IAQ.....	400
Pro1 IAQ Accessories.....	401
Ruud.....	403, 405, 514-515
Tekmar.....	292
Uponor.....	268
White-Rodgers.....	291, 406
Threaders	
Ridgid Manual.....	676
Ridgid Power.....	676
Thunderbolt Bits Milwaukee.....	580
Tie Downs Sioux Chief.....	656
Tie Tools Malco.....	775
Tie-Down Strap Lashing.....	638
Time Delay Relays Ruud.....	545-546
Timer Delays Ruud.....	546
Timers	
Grundfos.....	301
Lifebreath.....	8-9
Paragon Electric Defrost Controls.....	98
Tinner Snips Klein Tools.....	779
Tjernlund	
Draft Inducers.....	818
Duct Boosters.....	132
Duct Fans.....	132
Toilet Parts	
Kohler.....	489
Sloan Flush Valves.....	519, 521-522
Tool	
Hand.....	660
Milwaukee.....	660
Tool Bags Klein Tools.....	651
Tool Boxes	
Mill-Rose.....	643
Mill-Rose Drybox.....	643
Tool Holders Klein.....	651
Tools	
B&D Mfg Inc Flowmeter.....	214
Bramec.....	665
Bully Tools.....	784
Condenser Fin.....	638
Cordless.....	706
Delta.....	459
DiversiTech Telescoping.....	640
Fiberglass Flex Duct.....	775
Harvey Drain Cleaning.....	603
Jones Stephens.....	800
Klein Tools.....	623, 630, 636, 666, 683-684, 734, 751, 765-768, 778-779, 794

Lenox.....	574, 607, 609, 625, 659, 669, 736-737, 739, 754
Lutz.....	631, 764
Malco.....	137, 269, 500, 576, 598, 752, 755, 772-775, 795
Milwaukee.....	577, 580-584, 591, 593, 610-611, 613-614, 617, 652, 690, 695-696, 698-699, 704, 706, 709-710, 712, 714-719, 742, 746-747, 759-761
Pasco.....	586, 646, 797
RectorSeal Golden Tool.....	677, 798
Ridgid.....	589, 599, 632, 658, 670-671, 675, 680, 735, 741, 781, 783, 789
Ruud.....	588, 639, 641, 725
Seekonk.....	799
Sensible Products Motor & Wheel Pullers.....	802
Sioux Chief.....	668, 749
Uponor Installation.....	266
Tools Milwaukee	704
Tools Milwaukee	704
Tools/Gauges/Solder Ruud.....	728, 786
Topp Industries Sewage Basins.....	448
Torpedo Levels	
Klein Tools.....	636
Ridgid.....	632
Torque Wrenches Seekonk.....	799
TR Industries Cleaners.....	441
Tracer Wire Honeywell.....	408
Transformers	
Honeywell.....	409
Nordyne.....	569
Reznor.....	510
Robertshaw.....	411
Ruud.....	412
Sloan.....	523
Traps	
Bramec Condensate.....	347
EZ Trap Condensate.....	90
Sioux Chief Condensate.....	348
Traps & Connectors Ruud Heating & AC	551
Travel-Tack Hardcast.....	141
Triangle Tube	



Product Index

Boilers.....	256
Condensing Boilers.....	256
Parts.....	531
Prestige Parts.....	531
Trouble Lights Jones Stephens.....	788
TruFLOW Classic Manifold Extension Kit...	262
Trunk Duct Sheet Metal.....	161
Tub & Shower Accessories Basco.....	451
Tub Drain Tools RectorSeal.....	798
Tube Benders Ridgid.....	658
Tube Cutters	
Sioux Chief.....	668
Uponor PEX.....	267
Tube Heaters Schwank.....	330, 518
Tube Kit Nordyne Flex Tube.....	38
Tube Uncoilers Uponor.....	267
Tubing	
Cutter, Copper.....	660
Nordyne High Temperature.....	569
Ruud.....	553
Tubing Cutter Parts Ridgid.....	658
Tubing Cutter Wheels Ridgid.....	658, 664
Tubing Cutters	
Bramec.....	665
General Wire Spring Co Autocut.....	661
Lenox.....	659, 669
Milwaukee.....	663
Ridgid.....	657, 664
Tubing Tools Ridgid.....	589, 658
Tubing Transition Fittings QS-style.....	265
TurboShear Malco Drills.....	773
TVM	
Concrete Products.....	436
Insulation.....	435
TXV Kits Nordyne.....	38
TXV Valves	
Aspen Mfg.....	37
Nordyne.....	569

U

UEI	
CO Detectors.....	620
Digital Thermometers.....	620
Electrical Testers.....	621
Leak Detectors.....	620
Manometers.....	621
Multimeters Clamp-On Digital.....	620
UltraVation	
Air Purification Systems.....	5

Replacement Lamps.....	5
Uncoilers Uponor.....	267
Union Brass Parts.....	532
Unit Heaters Reznor.....	250
Upflow/Horizontal Gas Furnace	241-242
Uponor	
Brass Manifold Accessories.....	263
By-Pass Valves.....	266
EP Manifolds.....	262
Fast Trak Panels and Plates.....	265
Fire Sprinklers.....	204
Fitting Assemblies.....	264
Installation Aids.....	266
Manifold Accessories.....	263
QS-style Tubing Transition Fittings.....	265
Quik Trak Panels and Plates.....	265
TruFLOW Classic Accessories.....	324
TruFLOW Classic Manifolds.....	262
TruFLOW Manifold Accessories.....	262
Zoning Controls.....	268
Utility Boxes Handy Box.....	349
Utility Knife Blades Klein Tools.....	630
Utility Knives	
Klein Tools.....	630
Lutz.....	631
Malco.....	626
Milwaukee.....	627
Utility Strap DiversiTech.....	638
UV Air Cleaners Lamps.....	5
UV Air Purifier Honeywell.....	1
UV Bulbs Sanuvox Replacement.....	6

V

V-Belts Fenner Drives.....	478
Vacuum Breakers Sloan.....	525
Vacuum Gauges	
CPS Products.....	724
Sioux Chief.....	731
Vacuum Pump Oils Ruud.....	728
Vacuum Pumps Mastercool.....	723
Valve Assemblies Union Brass.....	532
Valves	
Amtrol Fill-Trol.....	321
Bell & Gossett.....	312
Bell & Gossett Dual Unit.....	312
Honeywell Burner Controls.....	356
Honeywell Gas.....	355
Honeywell SmartValve.....	357
Honeywell Thermostatic Mixing.....	270



Product Index

Jones Stephens Radiator Coin Key Air.. 276
 Nordyne..... 569
 Parker Hannifin Solenoid..... 107
 Reznor Gas..... 508
 Robertshaw Gas..... 359
 Ruud..... 129, 724
 Ruud Gas..... 516
 SpiroTherm..... 277
 Taco Inc Flo-Check..... 302
 Taco Inc Zone..... 327
 Uponor By-Pass..... 266
 Watts Regulator Boiler Drain Shut-Off... 295
 Watts Regulator Boiler Pressure
 Regulators..... 278, 310, 313
 Watts Regulator Radiator Steam 318
 Webstone..... 305, 315-316
Vari-Bits Lenox..... 574
Vent
 Deflect-O Dryer..... 216
 Deflect-O Specialty..... 216
 DuraVent Gas..... 826
Vent Caps Reznor..... 510
Vent Dampers
 Ruud Water Heater..... 516
 Weil-McLain..... 563
Vent Hoods Lifebreath..... 11
Vent Saddles Sheet Metal..... 191
Vent Termination Kit..... 551
Ventilating Fans Panasonic..... 809, 811
Ventilation DiversiTech..... 222, 804
Ventilators
 Honeywell..... 12
 Honeywell Fresh Air..... 423
 Lifebreath Residential..... 7
Venting Gas..... 805
Venting Caps Broan..... 825
Vents
 Bramec Wall..... 808
 Hoffman Specialty Main Steam..... 275
 Hoffman Specialty Main Water..... 275
 Hoffman Specialty Radiator Steam..... 275
Versa Cap Flue & Hot Stack Caps..... 804
Versa-Grip Hardcast..... 141
Vibration Pads Mason Industries..... 93
Vises Ridgid..... 781
Voltage Detectors Milwaukee..... 617

W

Wall Stack Galv Sheet Metal..... 201, 203

Wall Stack Elbows Sheet Metal..... 202
Wall Vents Bramec..... 808
Wallstack Duct Sheet Metal..... 200
Warranty Upgrades Ruud..... 516
Washers T&S Brass..... 528
Waste Assembly Parts Delta..... 469
Waste Repair Parts Dearborn Brass..... 458
Waste Valves T&S Brass..... 528
Water Connectors Woodford
 Thermaline® Sanitary..... 570
Water Cooler Parts..... 476
Water Cooler Repair Parts..... 476
Water Feeder Valves Watts Regulator.... 278, 310, 313
Water Feeders Hydrolevel..... 309
Water Gauge Components Apollo..... 322
Water Gauges Apollo..... 322
Water Heater Drain Valves Watts
 Regulator..... 295
Water Heater Parts
 Ruud..... 513
 Ruud Commercial..... 516
Water Treatment Products Nu-Calgon... 87
Water Vents Hoffman Specialty Main..... 275
Water-Right Inc
 Installation Fittings..... 560
 Replacement Parts..... 560
Watts
 Radiant Manifold Accessories..... 271
 Stainless Steel Manifolds..... 271
Watts Regulator
 Dielectric Unions..... 561
 Isolation Pump Flanges..... 307
 Radiator Steam Valves..... 318
WD-40 Lubricants..... 446
Weatherhood Kits Lifebreath..... 11
Webstone
 Ball Valves..... 305, 316
 Radiator Valves..... 315
Weil-McLain
 Baseboard Heaters..... 287
 Boiler Parts & Components..... 562
 Gas Boilers..... 258
 Heat Exchangers..... 303
 Ultra Series 3 Boiler..... 259-260
 Wall-Mount Gas Boiler 260
Well Assemblies Honeywell..... 286
Wheels
 Ridgid Pipe Cutter..... 671
 Ridgid Tubing Cutter..... 658, 664
Whips DiversiWhips..... 105
White-Rodgers
 Hydronic Controls..... 328



Product Index

Thermostats.....	291, 406
Zone Valves.....	328
Winter Watchman Honeywell.....	399
Wire Connectors Bramec.....	416
Wire Strippers Hilmor.....	686
Wire Strippers/Cutters Klein Tools.....	684
Wire Ties Ruud.....	417
Wireless Adapters Honeywell RedLINK...	419
Wireless Thermostats Honeywell.....	392
Wood Bits Lenox.....	574
Woodford	
Individual Parts.....	571
Repair Kits.....	570
Thermaline® Sanitary Water Connectors.....	570
Yard Hydrant Repair Parts.....	570
Work Gloves	
Milwaukee.....	827
Sioux Chief.....	829
Worklights MA-Line.....	787
Wrenches	
Jones Stephens.....	800
Klein Ratcheting Box.....	794
Klein Tools Adjustable.....	794
Lenox.....	792
Malco Ratchet.....	795
Mill-Rose Razorback.....	796
RectorSeal Golden Tool.....	677, 798
RectorSeal Pipe.....	798
Richard Specialty.....	793
Ridgid.....	789
Ruud Water Heater.....	514
Seekonk Torque.....	799
Wyes Sheet Metal.....	189

Y

Yaktrax Implus.....	845
Yard Hydrants Woodford Repair Parts.....	570

Z

Z-Line Pleated Filters Glasfloss.....	19
Zoeller Pump Parts.....	573
Zone Control Accessories Honeywell...	423
Zone Controls	
Honeywell.....	396
Honeywell Dampers.....	421
Taco Inc.....	290

Tekmar.....	292
Zone Kits	
Honeywell EnviraZone Networked System Kits.....	420
Honeywell TrueZONE.....	419
Zone Panels Honeywell TrueZONE.....	419
Zone Valves	
Honeywell Motorized.....	325
Taco Inc.....	327
Taco Inc Power Head.....	327
White-Rodgers.....	328
Zoning Controls Uponor.....	268



W A T E R

C O N C E P T S

Professional Plumbing Showroom

11 Locations Across Iowa

Ames Des Moines Iowa City
Cedar Rapids Fort Dodge Ottumwa
Waterloo Davenport Mason City
Spirit Lake Waukee

Consultations by Appointment

For more information please visit
www.waterconcepts.net

18 Iowa Locations

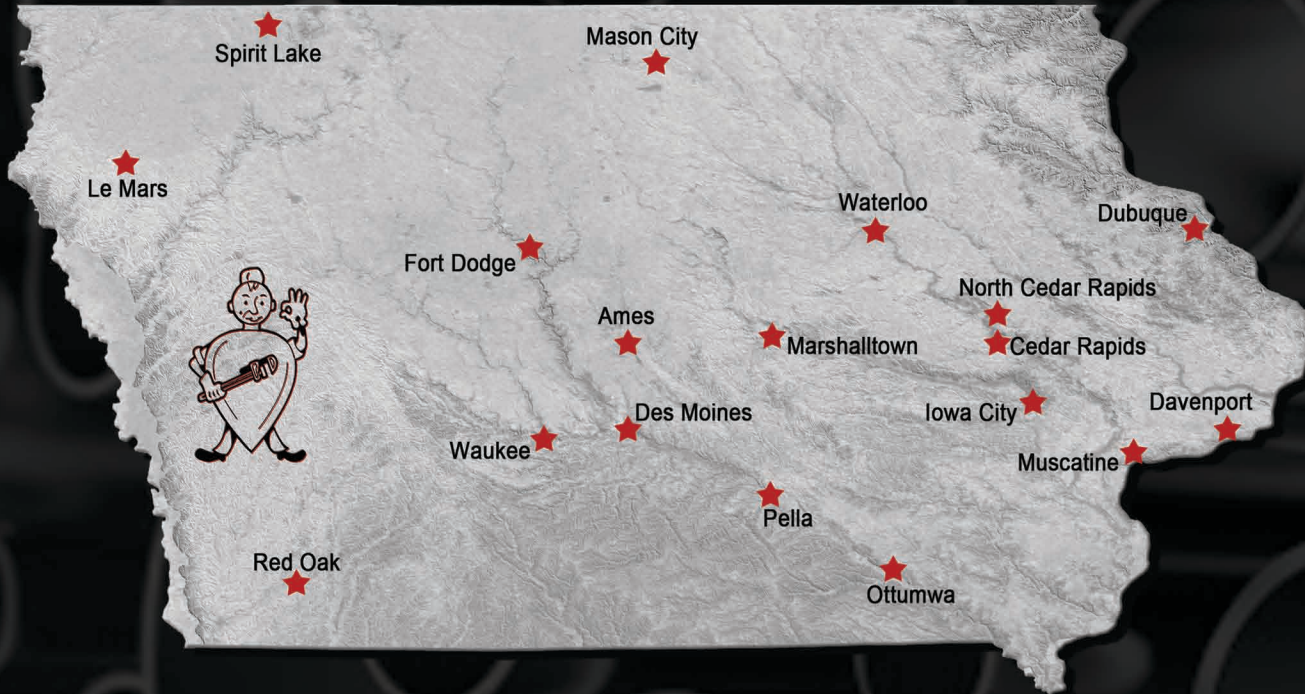

www.plumbsupply.com
www.facebook.com/PlumbSupplyCompany

Corporate Office
515-262-9511
1622 NE 51st Ave
Des Moines, IA 50313